



# *SSERC* *Bulletin*

**No. 221 Summer '07**

Ideas and inspiration supporting Science & Technology for all Local Authorities

*Face masks for asthmatics*

*Wizardry of finding a gene*

*Enzyme specificity - or is it?*

*Ion migration*

*Using tapeless video cameras*

*Digital video cameras - a comparison*

*Back to the '70s with ammeters & voltmeters*

*Radioactive sources in schools*

*Absolute measurement of atmospheric pressure*

*CPD News*

*SSERC Conference & AGM*

*SSERC Shop - Surplus*



## Face masks (cover story)

Recommendations of disposable masks for asthmatic students working with fungal spores are described.

### Introduction

SSERC received an enquiry recently in connection with the use of the SAPS ELISA kit for the detection of *Botrytis* infection in raspberries (see Fig. 1). The kit provides specific safety advice on its use. One particular safety point advises that if a user of the kit is asthmatic a face mask should be worn, as fungal spores may be released into the air during the experiment.

The enquiry we received focused on what we thought would be the best disposable masks to use for asthmatic students wishing to carry out the experiment, or indeed any other experiment involving fungal spores. See the table below for our recommendations, which have taken into account the need for a small pore size within the mask.

\* Best price found.

### All FFP3 Classification Masks

Manufacturer/Range (masks)	Key Catalogue	Protec Catalogue	RS Components
3M / 8833	/	£36.13 pk 10	/
3M / 8835	/	£19.69 pk 5	£5.75 each
3M / 9332	£44.35 pk 10	£34.69 pk 10	£4.60 each
JSP / Valved Moulded	£29.00 pk 5	/	£23.95 pk 5
JSP / Valved Folded	£36.00 pk 10	/	£41.50 pk 10
Respair / Economy	/	£7.57 pk 5	/
Respair / Cupped	/	£13.75 pk 5	/
Key / Budget	*£24.50 pk 20	/	/
Key / Regular	£11.50 pk 5	/	/
Website (www.)	keyind.co.uk	protecdirect.co.uk	http://rswww.com
Telephone	0845 6040660	0870 333 3081	08457 202201

Table 1 - Recommendations of disposable masks for asthmatic students



Figure 1 - Raspberries infected with *Botrytis*.

### References

HSE website: <http://www.hse.gov.uk/agriculture/dustmasks.htm>

SAPS website: [http://www-saps.plantsci.cam.ac.uk/workshop\\_elisa.htm](http://www-saps.plantsci.cam.ac.uk/workshop_elisa.htm)

It should be noted that the best disposable face masks/respirators should conform to BS EN149:2001.

In addition, the HSE advise the following with respect to respirators:

To help ensure you are protected, all respirators provided for use at work must be CE marked. Additional markings, such as FFP1, FFP2 or FFP3, indicate the protection level that you can get if the respirator is a good fit and you use it correctly. The higher the number, the better the protection. FFP1, FFP2 and FFP3 respirators can reduce the amount of dust you breathe by factors of 4, 10 and 20 respectively. An FFP3 respirator is advisable if you are exposed to high levels of grain dust or mould spores.

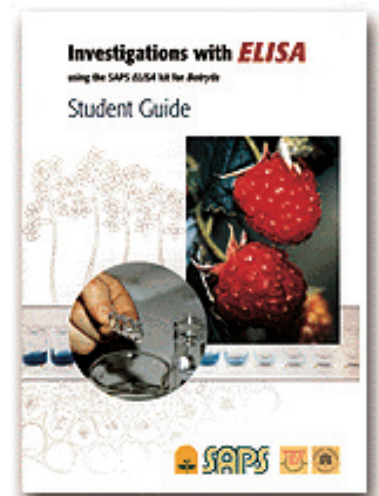

## The Wonderful Wizardry of Finding a Gene

### Introduction

Pupils have a great interest in all things forensic, particularly as a result of watching such TV programmes as *CSI* (Crime Scene Investigation). Many are therefore likely to have heard of DNA profiling, and may be curious to find out more. Besides its use in solving crimes, it can also be used to track the evolution of living organisms and movements of species; study genetic diversity; carry out gene profiling; and establish human relationships (e.g. in paternity or immigration issues).

DNA profiling makes use of the technique of gel electrophoresis, whereby large molecules of the same type (in this case DNA) within a mixture can be separated by size on the application of an electrical voltage. The gel is porous and so small molecules can move faster through the gel than large ones. Small molecules therefore travel further in a given time. Molecules of the same size travel the same distance and form a band on the gel. These bands of DNA can be stained to make them visible, so that the pattern of the bands can be assessed. In the case of DNA, the familiar 'DNA fingerprint' so often seen in the media, is characteristic of a particular individual. Hence its usefulness in the areas outlined above.



The aim of this activity is to allow pupils to carry out simple gel electrophoresis in order to simulate DNA profiling. The protocol uses mixtures of food colouring instead of DNA. On application of a voltage across the gel, the mixtures separate into bands of their individual colours. Each colour represents a gene for a 'magic power' so that this fun protocol allows pupils to identify the 'magic power genes' possessed by each of the wizards.

The activity was originally developed to reflect interest in the *Harry Potter* and *Lord of the Rings* books and films. Teachers may wish to adapt the protocol for a variety of different scenarios in which different properties are allocated to the coloured 'genes'.

This practical is one of a suite of resources developed by SAPS and SSERC to support the 'Inheritance' content of 5 – 14 Environmental Studies: Science. It was produced for the Improving Science Education through CPD project and is included in SAPS/SSERC 5 – 14 Biotechnology workshops.

### Setting up the Activity

For this activity, you need electrophoresis tanks, four-well combs, leads, carbon fibre electrodes, batteries or transformer, agar, water, mixtures of food colourings and micropipettes. Agar, water and mixtures of food colourings are used instead of the more expensive agarose, buffers and DNA required for DNA fingerprinting. Four-well combs are used in preference to six-well combs as this allows for inexperienced technique to be more successful.

The gel electrophoresis equipment necessary for this practical work formed part of the 'Protein Power' kit formed by the National Centre for Biotechnology Education and distributed free to all schools in Session 2002/3. However, additional equipment may be purchased from the *National Centre for Biotechnology Education* (NCBE) (full price list). At the time of going to press the 'Electrophoresis Base Unit' containing eight tanks plus supporting equipment costs £50).

### Preparation of gels

These can be made up in advance for the pupils. For ten tanks you will require approximately 160 cm<sup>3</sup> of molten agar (i.e. 16 cm<sup>3</sup> per tank).

Make up a 3% w/v solution of agar (i.e. 6 g agar in 200 cm<sup>3</sup> water) in a stoppered flask and heat on a hotplate stirrer or boiling waterbath until the agar melts and the solution goes clear.

Cool agar to 60°C in a water bath.

While agar is cooling, slot the combs into electrophoresis tanks and place on a level surface.

Pour the molten agar into the centre of each tank so that it flows between the teeth of the comb. The agar should be about 5 mm thick so that its surface is level with the plastic ridges which form the end channels.

Leave the gels to set (approximately 10 minutes) and then remove the combs gently.

Cover the gels with water to prevent them drying out, topping up as required.

### Preparation of 'Wizard DNA' samples

The 'Wizard DNA' is made by mixing liquid food colourings. Colours may vary depending on brand or shade of food colouring. We have used green, blue, yellow and black colouring of several brands and found them all to undergo satisfactory separation as a result of gel electrophoresis. Sucrose is added to make the mixture more dense. This helps the samples sink into the wells.

#### Method

Add 3 g sucrose to every 5 cm<sup>3</sup> of colouring and dissolve. Note: for ten groups, each with four mixtures, a total of 12.5 cm<sup>3</sup> green, 5 cm<sup>3</sup> blue, 2.5 cm<sup>3</sup> yellow and 1 cm<sup>3</sup> black food colouring is required).

Make up the required volumes in labelled tubes with food colouring mixed in the proportions shown:

Tube label	Food colourings
1	Green
2	1 blue: 1 yellow
3	1 green: 1 black
4	1 blue: 1 green

**Table 1** - Make up of each tube and colourings used.

Aliquot 0.5 cm<sup>3</sup> of each mixture into small, labelled tubes for the pupils. The labels can be numbers or letters which may relate to the names of the wizards (e.g. 'H' for Harry, 'D' for Dumbledore, etc).

### Pupil procedures

The four types of 'Wizard DNA' are loaded into separate wells using a micropipette from NCBE with a different tip for each sample (Figures 1 & 2). It may be worth spending a little time on the use of such pipettes beforehand. 20 µl of each sample is loaded and should sink to the bottom due to the presence of sucrose in

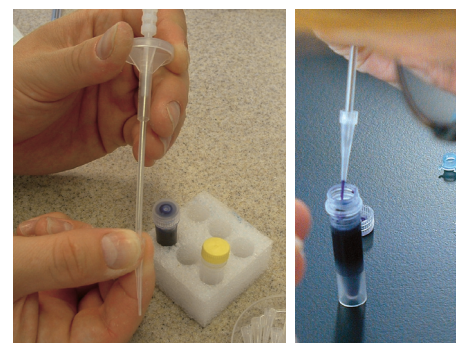

**Figures 1 & 2** - NCBE micropipette used to load the 'DNA' into the gels.

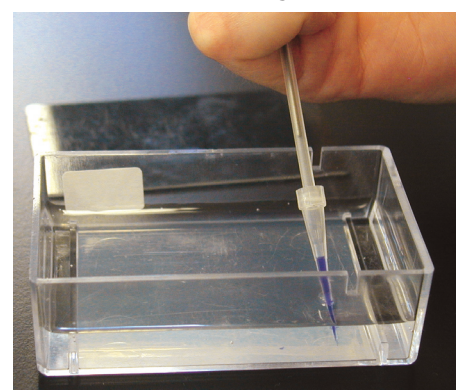

**Figure 3** - Loading the 'DNA' into the gel tank. Note that the tip of the micropipette is under the water.

the mixture. Pupils must ensure that the tip of the pipette lies below the surface of the water (Figure 3), but does not pierce the gel at the bottom of the well. Should this happen, the 'DNA' will disappear under the gel.

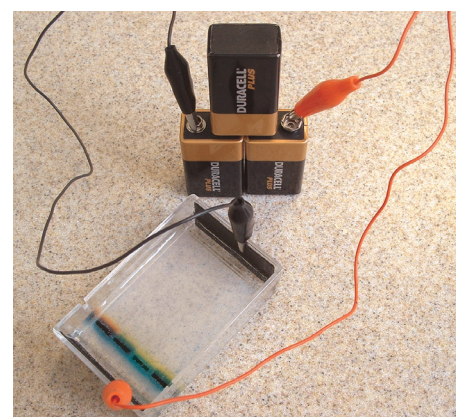

**Figure 4** - Loaded gel tank connected to three 9V batteries.

The carbon fibre electrodes are then placed at either end of the tank (Fig 4) and connected by wires and crocodile clips to the batteries[1]. The black (-ve terminal) clips go at the end nearest the wells, with the red clip at the vacant +ve terminal of the battery (Fig 5).

The apparatus can be left to run for as little as 10 minutes to see that the 'Wiz-

[1] Using 9V batteries for a whole class can be cumbersome and somewhat expensive. The next issue of the bulletin will outline a battery-free method which can be used for up to eight tanks at a time (Fig 6).



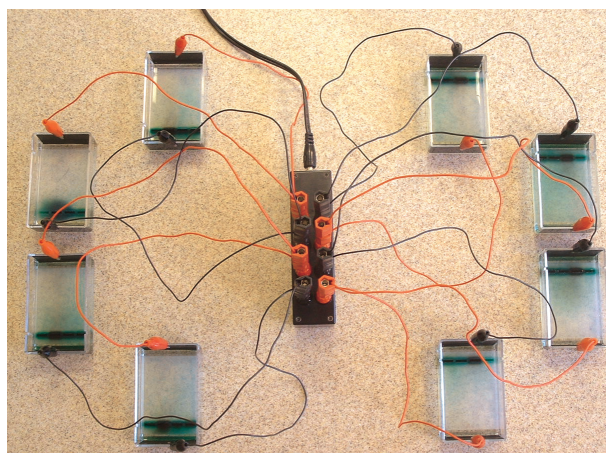
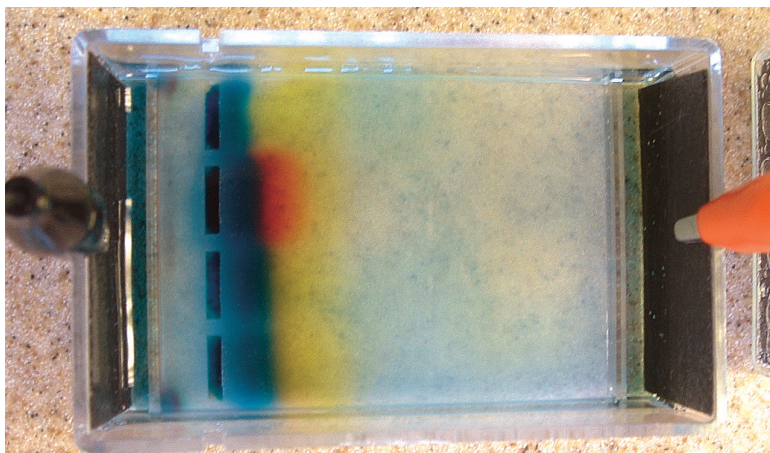

**Figure 5** - Voltage applied to the gel tank causes the 'DNA' mixtures to separate, resulting in characteristic banding patterns. **Figure 6** - No need for 9V batteries! (see next issue).

ard DNA' separates into different coloured bands (Fig 5). The wires should then be removed from the battery and tank and the water poured off. The bands of colour can then be examined and the magic power genes possessed by each wizard can be identified[2].

[2] This practical should run within the timescale of one teaching period, allowing the results to be observed and discussed. However, the results cannot be held over to the next lesson; food colouring molecules are of low molecular weight, and so they dissipate quickly through the gel.

Colour	Power	Ability Conferred
Yellow	Psychokinesis	Can move objects from place to place through thought
Pink	Transfiguration	Can change one object into another
Blue	Vanish	Can disappear in a puff of smoke
Red	Evil	Cannot block out evil
Orange	Creation	Can create objects from nothing

**Table 2** - Allocation of powers to particular genes in the story.

## Enzyme Specificity - or is it?

We have been receiving reports that the Intermediate 2 Biology LO3 experiment "Determination of the Specificity of Enzymes" is causing some difficulties for students. To recap the experiment, pupils examine the activity of four different enzymes (trypsin, amylase, urease, pectinase) with the substrate casein. The casein is mixed with agar and poured into a Petri dish to produce an opaque, white jelly. Wells are cut into the agar to hold the different enzyme solutions.

When casein is broken down, a clear zone appears in the milk agar around the well. The diameter of the clear zone is a measure of the activity of the enzyme. The intended outcome is that 2% trypsin solution will be the only enzyme that produces a clear area around the well, showing that this enzyme is specific for casein.

According to reports we have received, the well containing amylase also seems

to be causing the casein to break down (Fig 1). The reason for this may be that some amylase preparations can be contaminated with proteases. This would then produce a similar result to the trypsin, thus making the experimental outcome somewhat confusing to students.

Here at SSERC the experiment was tried with a variety of amylases at different concentrations. We also found it to be the case that certain amylases caused the casein to break down (Fig 2). However, by using 2% amylase provided by NCBE, casein breakdown was negligible if not altogether absent, allowing the well containing trypsin to be shown as the only one producing the desired effect (Fig 3).

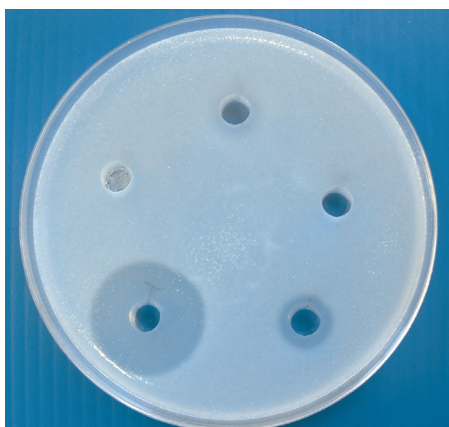

**Figure 1** - A typical problematic result after 2-3 hours incubation at 37°C followed by storage at 4°C for 24 hours. Wells contain (clockwise from the top): 2% pectinase solution, water as control, 2% liquid alpha amylase (Philip Harris), 2% trypsin solution, 2% urease solution (Philip Harris)

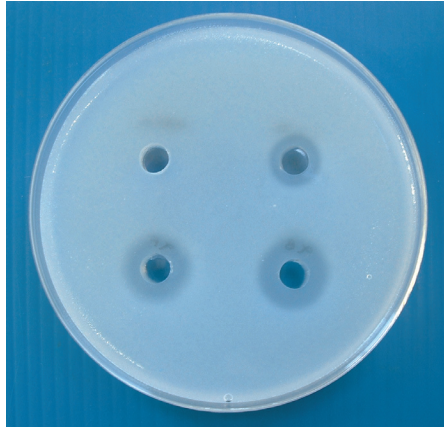

**Figure 2** - The effect of different amylase solutions on casein breakdown. Clockwise from top: 2% NCBE bacterial alpha amylase (liquid), 2% bacterial alpha amylase (Philip Harris liquid), 2% bacterial alpha amylase (Philip Harris powder), 2% fungal alpha amylase (Philip Harris powder)

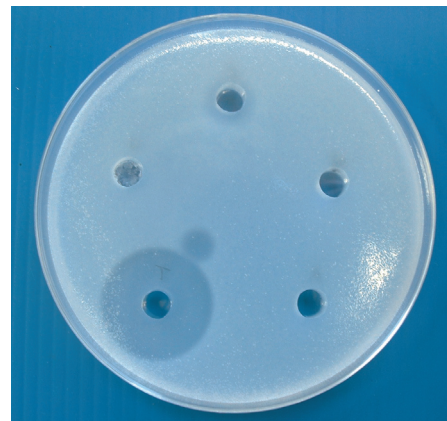

**Figure 3** - Experiment set up as for Figure 1 with NCBE amylase replacing Philip Harris amylase. No digestion evident.



# Ion Migration – Copper(II) chromate(VI)

## Introduction

We had some queries from technicians unable to get this demonstration to work. Furthermore we found that some younger technicians and chemistry staff had never even heard of it! It can be used in Standard Grade Chemistry to help show the existence of ions.

## What you will need

### Chemicals

copper(II) chromate(VI) solid (toxic)  
hydrochloric acid, 1M (irritant)  
nitric acid, 1M (corrosive)  
urea

### Equipment

filter funnel  
filter paper  
beaker, 250 cm<sup>3</sup>  
hot plate  
spatula  
stirring rod  
thermometer, stirring  
teat droppers, 2 off  
"W" tube (Griffin Education Catalogue, page 101 Cat. No EKW-224-552B, £7, [1])  
beaker, 500 cm<sup>3</sup> (used as a water bath with cold water to minimise convection of solutions)  
stand, with bosshead and clamp  
power supply, low voltage (0-12 V dc)  
wires, platinum (for electrodes)  
crocodile clips, 2 off  
leads, 4 mm connecting, 2 off  
goggles, indirect vent  
gloves, nitrile

## Preparing the solution

Heat some 1M hydrochloric acid to about 60-70°C and add excess copper(II) chromate to make a hot saturated solution. Allow to cool and filter off the excess solid.

Dissolve urea in this solution. Urea is very soluble and a large amount will be required. The density of this solution is critical, not the concentration of urea it. This should be sufficient to allow the formation of two distinct layers when added to the 1M nitric acid (see 'Setting up the apparatus'). Something approaching a saturated solution of urea in the copper chromate is ideal.

## Setting up the apparatus

Use a teat dropper to place some 1M nitric acid down the back limb into the "W" tube (Figure 2).

Now use a second dropper to carefully and slowly pour copper(II) chromate(VI) solution down the back limb into the "W" tube, making sure the tip of the dropper touches the glass. This should form a bottom layer and force the nitric acid up the side arms of the tube.



Figure 1 - Apparatus & chemicals



Figure 2 - Using dropper



Figure 3 - with electrodes

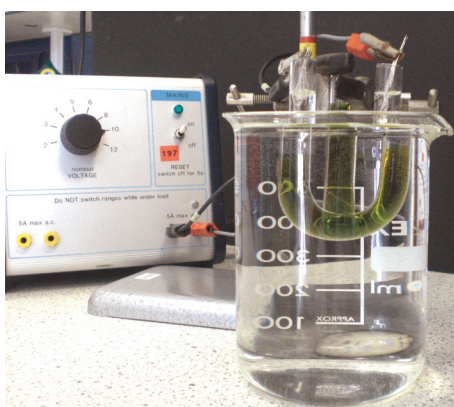

Figure 4 - Connect Pt electrodes and immerse W-tube partially in water-bath beaker  
Connect up the platinum wires (Figure 3) and immerse these in the top of the nitric acid, ensuring they are some distance from the top of the chromate solution.

Carefully clamp the "W" tube and lower the legs into the 500 cm<sup>3</sup> beaker. Fill the beaker with cold water to minimise convection currents in the W-tube.

## The Demonstration

Set the voltage to between 10-12 V dc and switch on. Bubbles should appear at the wires.

Leave it running for about an hour to see a blue colour in the acid at the negative electrode, and an orange colour in the acid at the positive electrode (Figure 6).

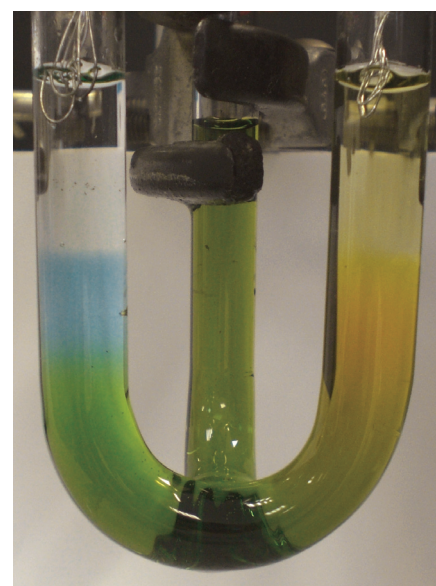
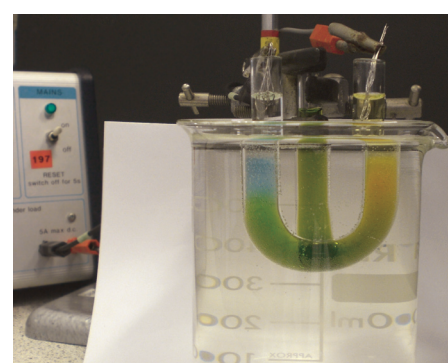

Figures 5 & 6 - Blue and orange colours evident at the negative and positive electrodes after about an hour.

## Hazards and Control Measures

Chemical	Main Hazard	Control Measures
Copper(II) chromate(VI)	May cause cancer and is a skin sensitiser	Avoid raising dust from compounds in the solid state and wear nitrile gloves and indirect vent goggles while preparing the solution.
Hydrochloric acid (1M)	Irritant	Wear gloves and eye protection.
Nitric acid (1M)	Corrosive	Wear gloves and indirect vent goggles.
Hot plate	Electrical: Burns	Check wires etc. & that it has been PAT tested before use; Ensure safety notice on view while hot.
Power supply	Electrical	Check power packs (wires etc) plus been PAT tested before use. Use low voltage.

1. <http://www.catalogue.fisher.co.uk/catalogue/griffinbrowse.htm>  
(Copy "EKW-224-552B" into Product Code box)



# Using Tapeless Video Cameras in Science Classes

## Introduction

Many schools and individual teachers now own digital cameras. This article covers the use of the "video clip" feature found on many of these devices. Note that some cameras are now marketed as "tapeless camcorders", designed specifically for video work. These cameras, such as the *Mustek DV 5000* and *5300SE* (Figures 1 & 2) and *Sanyo Xacti* (Figure 3) ranges may not offer many more video features than conventional digital cameras but their design makes them easier to use for that purpose. Additionally, they tend to be able to compress video files in such a way that more footage can be stored in their memory. The cameras described here can play back videos either via the small LCD screen or directly through the computer or TV, immediately and without the addition of any extra equipment save for a connecting cable. Alternatively, the clips can remain on the camera or can be transferred to a computer with the supplied software installed, for editing and playback later.

## Uses

### Bringing real world into the classroom

Many teachers now supplement their lessons with still photographs taken on digital cameras or downloaded from the Internet. The increased use of whiteboards and digital video projectors complement the use of these perfectly.



**Figure 4** - Knockhill race circuit - a good source of dynamic footage

Digital video adds another dimension. For example, one teacher visited a wind farm and took video footage, panning around to give the children a better idea of the scale of the site and the relative size of the turbines. This opened up discussion on the impact of alternative energy solutions on the Scottish environment. A teacher visiting Knockhill race circuit recorded a yellow Ferrari driving round the track (See the online version on the SSERC website [1]). He found out the length of the track from information posters at the venue. On returning to work, he replayed the video to his class during the S4 Transport section of Physics



**Figure 1** - Mustek DV5000 tapeless camcorder

Standard Grade, discussing with them how they could find the average speed of the car.

Extensive data on all the F1 circuits and statistics on the drives completed thus far can be found on the web [2].

### Sharing learning intentions or summarising lessons

Video editing software, which is often bundled with the camera, makes it fairly easy to string together a number of clips into a short film. All have the ability to add titles and sound tracks. One teacher used this feature to summarise the key learning points of a 5-14 lesson on forces, interspersing text with film of the children working on a practical activity.

### Reviewing practical work

When practical work is used to challenge the children and open up discussion it can be useful to have a record of the work to review with them. This has been used, for example, to record the results of a class's investigations into the attraction and repulsion seen when various types of plastic rods are charged by rubbing then brought together. The film clips were projected on to a screen and discussed.

### Presenting investigative work

Many teachers are aware that individual pupils have their own preferred learning styles. Similarly, some pupils may be much more motivated if they are allowed to present their work to camera rather than solely on paper. Note that not all digital cameras with a video facility can record sound, though the camcorders mentioned here can do so. The Mustek can record sound files as separate entities so can be used as a digital audio recorder also.

**Motion analysis** - see future Bulletins for more on this area where video clips and other software are used.



**Figure 2** - Mustek DV5300SE tapeless camcorder - available for around £60 with 512 Mb of memory.



**Figure 3** - Sanyo Xacti tapeless camcorder. Costs around £130.

## Technical issues

Most digital cameras store video clips as individual files memory or on a memory card. When the camera is connected to a computer, it usually appears as an extra disc drive. The video files can be moved and copied in the usual way or played directly from the camera.

Older computers running *Win98* or lower may require a small file (driver) to be installed to allow camera and the computer to communicate. This is often supplied on a CD with the camera.

There are a number of different types of video file formats. Most computers will play most types. Occasionally, when you try to play a file, the computer will report that it does not have the correct *codec*, the file that decodes a video clip. Some computers download these automatically from the internet. In other cases, you may need to seek help.

File formats play a part when it comes to video editing. Video editors allow you to cut parts out of your clips or put them together with titles and sound tracks. The latest Windows computers come with a free video editor called *Windows Movie Maker*. This is a little limited when compared with packages such as *Pinnacle Studio* or *Ulead VideoStudio* (video editors used in a number of schools) but it is an excellent starting point and is easy to use.

1. [www.sserc.org.uk/members/SafetyNet/bulls/221/ICT.htm](http://www.sserc.org.uk/members/SafetyNet/bulls/221/ICT.htm)
2. [www.formula1.com/](http://www.formula1.com/)



## Digital Video Cameras - a comparison

We looked at two cameras that could be used to take video clips for use in the classroom.



**Sanyo Xacti C4** - This costs around £130 including VAT and purchasers would be wise to add a SD card of at least 512MB. Such a card would give around 20 minutes of filming at the Sanyo's maximum quality setting. At this setting, it takes video pictures at a rate of 30 frames per second and a resolution of 640 x 480 pixels. This is slightly below DVD quality but is at least as good as an old-style analogue camcorder. Motion is smooth, colours are natural and detail is good. There is little sign of blockiness. The Sanyo has an autofocus facility and both optical and digital zooms. It creates .MP4 files. These can be played on computers with version 6.5.2 of Quicktime or above installed. At the time of writing, a number of the computers we tested this camera with did not play the files as they did not have this version of Quicktime installed. Fortunately, it is easy to convert .MP4 files to a format that Windows Media Player and most video editors will recognise, though the immediacy of being able to take a video clip in the classroom and play it straight away is lost. This is unlikely to be an issue for much longer as more computers are updated to the latest version of Quicktime. Windows Movie Maker could not edit Sanyo files but Ulead VideoStudio 10 Plus could. Like Movie Maker, some other editors would require file conversion. A free converter is available at <http://mp4cam2avi.sourceforge.net>

When we investigated using Logger Pro software from Vernier to analyse motion captured on video, we found that it could import the Sanyo's video clips without conversion.

The Sanyo can also play clips to TV and produces very good still pictures. It has a built-in replaceable rechargeable battery and can connect to a computer via the charging cradle or a USB lead.



**Mustek DV5000** - This has now been replaced by the similarly-priced DV8200. The camera costs around £60, inclusive of VAT. One retailer was giving away a 256Mb SD card at this price, a useful addition that would allow around one hour of video. The DV8200 has a higher resolution image sensor than the DV5000 but the video resolution is the same in each case at 640 x 480 pixels. At this resolution, a frame rate of 10 frames per second is possible. If faster frame rates are to be used, resolution drops. Although nominally the maximum resolution is the same as that of the Sanyo, picture quality does not seem as good. Colours are slightly flat and some edges in images have a serrated appearance. That said, quality still approaches that of older, non-digital tape camcorders. The Mustek's lens has only two focus settings, normal and close-up. It has a digital zoom, meaning that zooming in on objects reduces the picture quality. The Mustek creates MPEG 4 files with the file extension .ASF. File transfer is by USB. Files were playable in most of the computers we tried. Machines that initially did not play them subsequently did so when a package called DIVx was installed. Again, this is free and can be found at [www.divx.com](http://www.divx.com).

Windows Movie Maker 2 was able to take the Mustek's files and edit them without conversion, as was Ulead VideoStudio 10 Plus. Other video editors required conversion. A free converter is available from [www.stoik.com](http://www.stoik.com)

The Mustek can play clips directly to TV. It can also function as a still camera, voice recorder and MP3 player. Stills quality was well below that of the Sanyo to the point where we could not rely on the Mustek for acceptable stills in any but the best of lighting conditions. Unlike the Sanyo, the Mustek takes conventional AA batteries. Whilst we would recommend using NiMh rechargeables, the wide availability of AA batteries in shops makes it unlikely that the user would ever be stuck with an unusable camera.



### Mustek DV5300SE (Quick Review)

Just before going to press we bought a Mustek DV5300SE camera. This is similar in specification to the DV5000 but is far more capable at taking stills. It lacks the DV5000's close up mode but can handle time interval recording (short bursts of video at regular intervals) and can be set to record when motion is detected.

Those at SSERC who have used it have found it to be excellent value for money. We got ours from CPC ([www.cpc.co.uk](http://www.cpc.co.uk)), part number CS13015.

A company called *3wisemonkeys* is doing them for around £60 c/w a 512 Mb SD card - <http://www.3wisemonkeys.co.uk/products.jsp?cat=14>

Sanyo Xacti	
For	Against
Fast frame rate	A number of computers cannot play or edit files without suitable (free) software upgrades. (This is unlikely to be an issue for much longer)
Good quality video & still pictures	
Optical zoom	
Mustek DV5000 & DV5300SE	
For	Against
Inexpensive	Still pictures rather poor (much better with the newer 5300SE)
Files playable instantly on a wide variety of machines	
Takes standard AA batteries - reasonable life with high capacity NiMh batteries	Lower resolution required if fast frame rate is used.
Light & compact	No optical zoom



## Back to the Seventies with Ammeters and Voltmeters

Picture the following (somewhat unlikely) scene. BBC television remakes hit police drama *Life on Mars* but transfers the setting to a physics department. It is 1973. In an attempt to get the detail correct, the male teachers wear flared trousers, there are Ford Cortinas and Vauxhall Vivas in the car park and different set-ups for measuring current and voltage depending on whether the resistance to be investigated is low or high. We smile wryly at the cars and fashion and are thankful that modern digital meters have removed the necessity for the different circuits. Or have they?



A query came in to SSERC just before Easter. A class had been investigating the characteristics of a semiconductor diode. When it was forward-biased, the resulting I/V graph was as expected. On reverse bias, however, the results seemed very much at odds with the theory that the leakage current was "fairly independent" of the p.d. Indeed, the diode appeared to be ohmic in its behaviour, with a resistance of around a mega ohm. It turned out that the pupils had been using the circuit in Figure 1.

The difference was far less marked when we repeated both investigations using the higher-specification Rapid DMM310 meter. Further investigations confirmed a 310DMM has an impedance of around 10 MΩ and a 212DMM an impedance of approximately 1 MΩ. In most classroom situations, these meters can therefore be used in parallel with the component if the p.d. across the component is to be measured. Exceptions are when current is also being measured and the component has an impedance comparable to or greater than that of the meter. Another situation where this might occur is when investigating an LDR in darkness. Note that in the "high resistance" circuit of Figure 2, there will be a p.d. across the ammeter. This will lead to an inaccurate reading of the potential difference across the diode. Given the relative resistances of the ammeter and the reverse-biased diode, this will have a negligible effect.

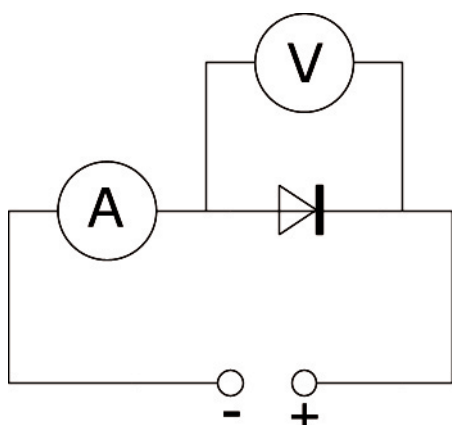

Figure 1 - Ammeter and voltmeter in "normal" positions.

The culprit responsible for the pupils' misleading results was thus almost certainly a wrongly-positioned voltmeter. To which we can only say, in the words of The Sweeney's Jack Reagan, "Get yer trousers on, you're nicked!"

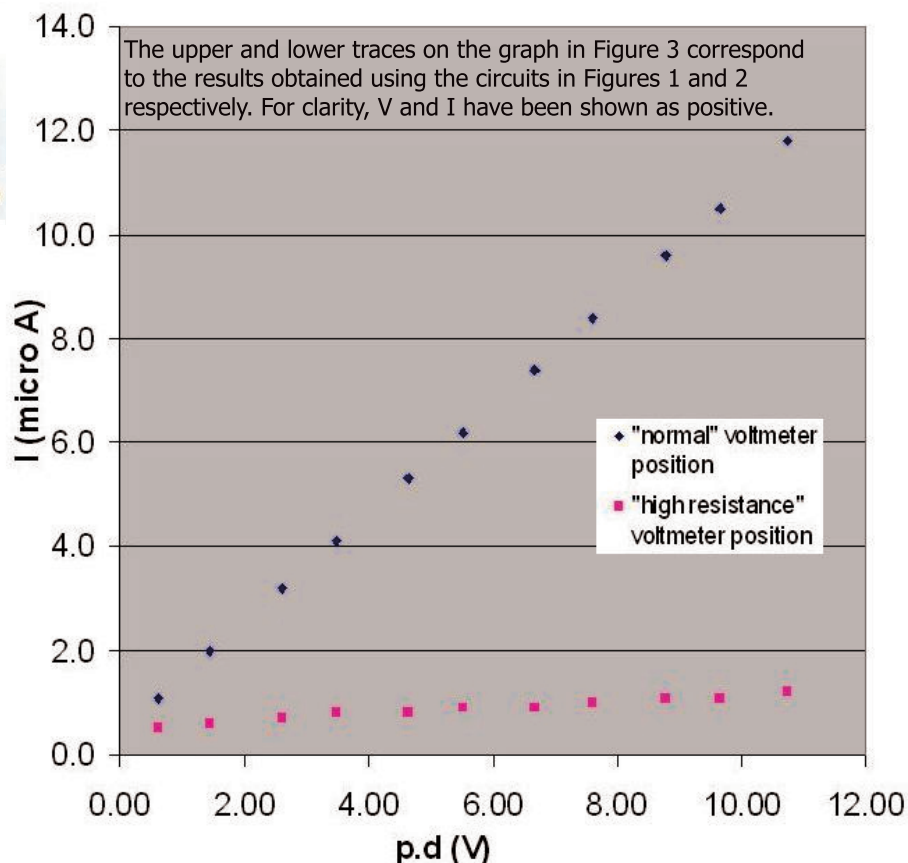

Figure 3 - Results from the two circuits.

The culprits responsible for the pupils' misleading results were thus almost certainly a wrongly-positioned voltmeter. To which we can only say, in the words of The Sweeney's Jack Reagan, "Get yer trousers on, you're nicked!"

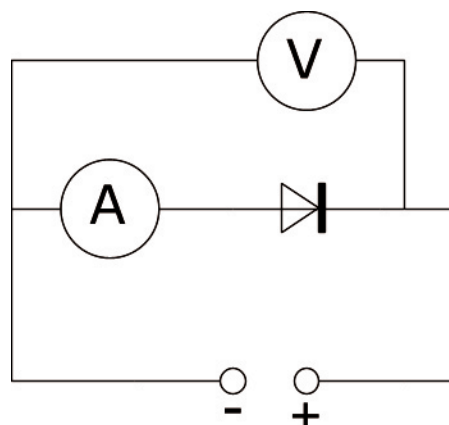

Figure 2 - Ammeter and voltmeter in "high resistance" positions.



Figure 4 - Rapid 212 digital multimeter



# Radioactive sources in schools

## Background to the survey

The need for a survey to find out exactly what radioactive materials were being held by schools was recognised some time ago. While preparing to carry out such a survey, SSERC was independently asked by the Environment Agencies (SEPA and the EA) to participate in the Surplus Source Disposal Programme (SSDP), a UK-government initiative. Agreeing to this proposal, the survey has been conducted by SSERC and managed by the SSDP Board, with the support of the Scottish Executive.

## Survey findings

SSERC now has a list of holdings in all council-run schools and all but a handful of independents. Thus the picture we have of the holdings is almost complete.

The significance of this is much wider than just radioactive materials. Regarding these substances or articles as a subset of the whole set of laboratory resources the data-set might be regarded as a reflection on the national stock of science equipment in all of Scotland's schools.

Of the 399 schools with an S3/S4 intake, 84 (21%) have no radioactive material, 31 (8%) have materials, but none that are of any use, and 244 (61%) have one or more sealed sources. The other 36 schools seem to be working with radioactive materials that aren't in the form of sealed sources. These materials are rocks mainly.

About 70% of the radioactive materials are between three and four decades old, having been acquired when the school began teaching the then Revised Physics syllabuses that were introduced in the '60s. There have been relatively few sources replaced. The only significant replacements have been:

Distribution of holdings (Number of sources)

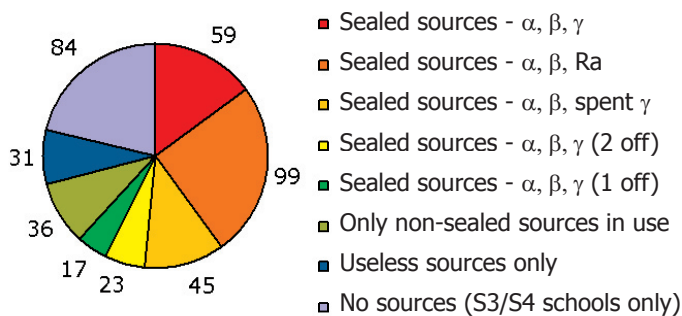

- The substitution of a protactinium generator for a thoron generator around 1988-90.
- The replacement of Co-60 sealed sources needed for two set Higher Physics practicals in the '90s or '00s.
- The substitution of old sealed sources with sets of rocks, mainly in the '90s or '00s.

There are only 60 schools with a viable set of alpha, beta and gamma sources (Am-241, Sr-90 and Co-60). Only 67 schools have a Co-60 source that's fit for use in showing the inverse-square law or half-value thickness experiments. That is, 83% of the country's schools have no practical means of showing these effects.

A matter of concern is the large number of anonymous (unmarked or unlabelled) sources (there are about 700 of them), many of which had not been known about before being found by the survey. Another concern are the many stocks of uranium and thorium compounds (in about 100 separate containers). The protactinium generators were a recognised problem. The survey will allow them to be disposed of.

## Strategy for the future

SSERC reported to the Annual Conference in December 2006 [2] and will be writing to all schools with sources, and councils, with advice on what to do.

Basically most of the radioactive materials being held should be disposed of now. The list includes radium sources because of the expense, protactinium generators, spent sealed sources and unmarked sources. The UK government will meet the costs where disposals have to be paid for.

Most types of sealed sources and uranium and thorium compounds can be disposed of locally, with refuse (subject to conditions about which you will be notified). Because there is no foreseeable cost in getting rid of many types of sealed source, we advise that

some old sealed sources of the nuclides Am<sup>241</sup> and Sr<sup>90</sup> should be retained and used until replacements are obtained. You will be informed about this by letter or email.

Reviews of two new half-life sources (AEA Cs-137/Ba-137m Isotope Generator and the Cooknell Ionisation Chamber) were published in Bulletin 218 [1]. Both are easy to operate, and both effectively show radioactive decay.

Because science is evidence-based, science teaching, wherever possible, ought to be founded on observation, discussion and experiment. We advise that every school should be stocked with a set of three sealed sources and one or both of the new half-life ones referred to [1].

## References

1. [www.sserc.org.uk/members/SafetyNet/bulls/218/Half\\_life\\_demos.htm](http://www.sserc.org.uk/members/SafetyNet/bulls/218/Half_life_demos.htm)
2. Radioactive sources in schools: National survey: Main findings

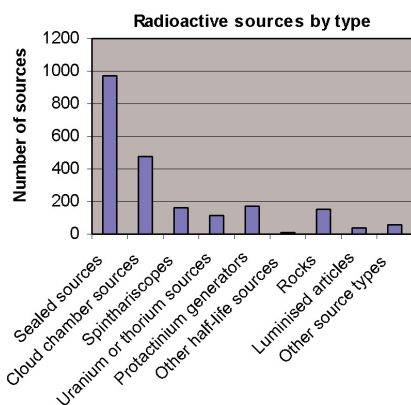

Decade of purchase: all source types

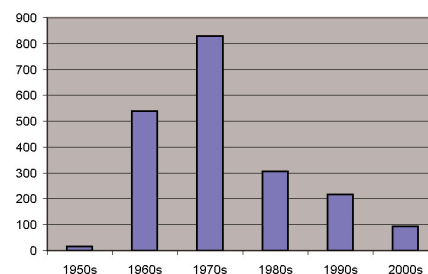

Use of other materials in schools that do not have sealed sources

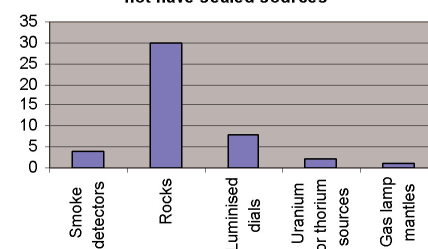



# Obtaining an Absolute Measurement of Atmospheric Pressure

## Introduction

This experiment is an extension of the well-known trick of placing a piece of card over the opening of a container of water and inverting it [3]. Air pressure keeps the card in place. In this case, a ping-pong ball is held in place over the neck of a bottle. Measurements can then be made to determine an absolute value for atmospheric pressure. The idea for this activity comes from The Physics Teacher [1].

- $p_{atm}$ : atmospheric pressure (Pa)
- $p$ : air pressure inside bottle (Pa)
- $V$ : original volume occupied by air in the bottle ( $m^3$ )
- $h$ : height of water column (m)

$\Delta V$ : this is the small increase in the volume occupied by the air in the bottle when it is inverted and water drips out. It is equal to the volume of water that drips out of the bottle. ( $m^3$ )

If the ball remains in place after water has dripped out:

$$p_{atm} = h\rho g + p \dots\dots\dots\text{equation (1)}$$

Note that no air enters the bottle, keeping the mass of air in the bottle constant. Hence, Boyle's Law can be applied:

$$p_{atm} V = p (V + \Delta V) \dots\dots\dots\text{equation (2)}$$

Combining equations (1) and (2),

$$p_{atm} = h\rho g \frac{(V + \Delta V)}{\Delta V} \dots\dots\dots\text{equation (3)}$$

For our work we used a 500  $cm^3$  Fisher Brand bottle. If the bottle is inverted over a beaker, the increase in volume occupied by the air can be found by measuring the mass of water collected. Since water has a density of 1  $g\ cm^{-3}$ , the increase in volume  $\Delta V$  is easily found. In practice, there will be spillage of water. If the experiment is performed over a paper towel, the increase in mass of both the beaker and the paper towel can be used to determine the increase in volume. Height was measured using a 30 cm ruler. A balance able to read to 0.01 g was used to measure  $\Delta V$ .

Another approach is to measure  $h$  and  $\Delta V$  for various volumes of air. This is best achieved by filling the bottle to the brim with water, then emptying out the required volume.

If equation 3 is rearranged, we have:

$$h\rho g = p_{atm} \frac{\Delta V}{(V + \Delta V)}$$

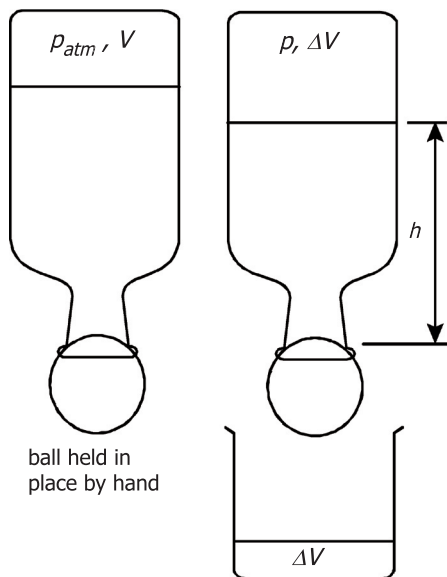

Figure 1 - Basic set-up.

Thus, a graph of  $h\rho g$  versus  $\frac{\Delta V}{(V + \Delta V)}$

should be a straight line through the origin.

The gradient should be  $p_{atm}$ .

## Results

Raw measurements of atmospheric pressure gave values between 94 kPa and 124 kPa. Using the graphical method, graphs initially displayed a large scatter of points and a gradient equal to 89 kPa, derived using Excel's LINEST function. With practice, 98 kPa was obtained. One of the original graphs is shown below.

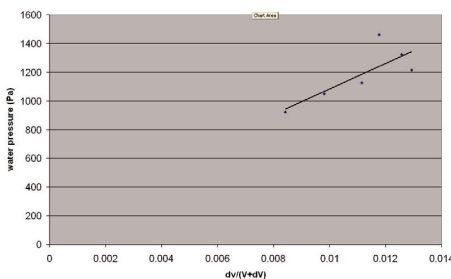

Figure 3 - Example graph.

## Evaluation

To achieve any degree of accuracy with this apparatus takes practice and teachers may feel that the time penalty incurred by this is too great. It cannot be introduced at the time that air pressure is taught, as an understanding of Boyle's Law is also essential. A number of pupils will find difficulty in following the derivation of equation (3) above. There are, however, a number of points in favour of carrying out the activity. Firstly, it presents a cognitive challenge. Can students explain why water always drips past the ball whenever the experiment



Figure 2 - Actual equipment.

is done? Are they able to say why more water drips past the ping-pong ball when the volume of water in the bottle is smaller? SQA reports [2] cite that candidates need experience in tackling this sort of non-numerical scenario. The set-up is also a problem solving plus one, requiring the application of more than one physics concept. It could thus be introduced after teaching the gas laws, using the following approach:

Demonstrate the apparatus. Ask students to discuss, in groups, why the ping-pong ball remains in place. Repeat the demonstration using a different volume of air in the bottle. Point out that more water escapes when the volume of water in the bottle is smaller. Students should discuss why this is so. Given the diagrams, they can then derive equations (1) and (2), with the more able going on to combine them to get equation (3). Each group could then measure  $h$  and  $\Delta V$  for a particular volume  $V$ . Bearing in mind that practice will be necessary before meaningful measurements can be made, it is unlikely that time would permit every group to measure a range of values for these quantities. Results could thus be pooled if the graphical approach was taken. The experiment could also form part of an Advanced Higher investigation on air pressure.

## References

1. The Physics Teacher, Vol. 44, November 2006, P492
2. SQA Higher Physics 2006 Principal Assessor's Report
3. [www.ise5-14.org.uk/Prim3/New\\_Guidelines/Newsletters/38/Under\\_Pressure.htm](http://www.ise5-14.org.uk/Prim3/New_Guidelines/Newsletters/38/Under_Pressure.htm)





**Science**  
LEARNING CENTRES

**A course for new and aspiring Heads of Faculty and Principal Teachers Curriculum**

**CONTINUING PROFESSIONAL DEVELOPMENT**  
*Teaching in Scotland*

**IMPROVING ACHIEVEMENT IN SCIENCE**

**Develop your confidence and competence in leading and managing a constantly improving faculty or department**

**Limited to 30 places**  
See the SSERC website for Information leaflet and first call for notes of interest and applications (pdf, 560K, see address below)

**Offered through the Scottish Science CPD Partnership in collaboration with the UK National Science Learning Centre located at the University of York**

**Three days scheduled for the 6th - 8th of November 2007, at the Glasgow Marriott Hotel with a two day follow up in May 2008**

[www.sserc.org.uk/members/SafetyNet/bulls/221/A3HoSCrse\\_2007\\_6\\_Press.pdf](http://www.sserc.org.uk/members/SafetyNet/bulls/221/A3HoSCrse_2007_6_Press.pdf)

**Rationale** - A number of Scottish schools and education authorities have moved to new organisational structures for the management of school courses and curricula. Others are considering such a move. These new structures often involve groupings of science specialisms and even a linking of the sciences with related subjects in faculties.

**Audience** - To cater for such changes, new middle management posts have been created at Head of Faculty or Principal Teacher (Curriculum) level. This course is mainly intended for the holders of these posts or those who aspire to hold such a post. The course may also appeal to those aspiring to hold other kinds of promoted or 'middle management' posts in science education. Some preparation and training for such posts may well be provided through generic courses. Leading and managing faculties and developing a new science curriculum also require some specific kinds of knowledge and skills.

**Course description** - The course will draw on the content and adopt many of the approaches used for the "Heads of

Science" Course developed by the UK National Science Learning Centre in York. Control over the detailed design and delivery plans, however, is largely in the hands of a practitioner group based in Scotland. Delegates in the first cohort for this course said:

"A very enjoyable and practical course . . ."

"Should be open to all PTs/Faculty Heads".

"This is how to ensure you're up-to-date."

#### Coverage

- learning and teaching with emphasis on innovative approaches to motivation and improving classroom relationships so broadening and enhancing achievement
- leading teams and managing change
- departmental/faculty issues and policies
- sensible and balanced approaches to health and safety
- curricular issues and course development with particular reference to the 3 - 18 review of science as part of a Curriculum for Excellence

- reference to HMIe reports such as Improving Achievement in Science

#### Quality Assurance

Course development and delivery will follow quality assurance procedures based on those of the UK National Science Learning Centre.

#### Commitment

Participants will be expected to carry out an agreed action research task, or a similar exercise, in school between November 2007 and the recall days in May 2008.

#### Costs

Admission to the course is dependent on nomination by your school or local authority and on submission of a satisfactory application. Successful applicants will be supported through the NSLC Impact Award scheme - when the total direct cost (i.e. all fees and accommodation but excluding travel and staff cover) will be £500.

## Something old, something new, something borrowed, something ?...

This is advance notice of a number of two part CPD courses, for teachers of Primary, Biology, Chemistry and Physics, which are to be run in support of the implementation of a *Curriculum for Excellence*. The courses are being organised by SSERC and its partners in the *Support for Science Education through CPD* project.

Teaching approaches and resources to support learning will be key features of these courses. Using equipment supplied on the course, participants will be encouraged to undertake a collaborative, classroom-based project. During the second part of the course,

SSERC Bulletin 221 Summer 2007

they will have an opportunity to share their good practice based on the project work. Part 1 (in the Autumn term) will run from a Thursday evening until Saturday lunchtime, part 2 (in the Spring term) from a Friday until Saturday mid-afternoon. The venue will be SSERC in Dunfermline and local hotels in Fife.

For initial enquiries, please contact *Sheila* on [sheila.maclellan@sserc.org.uk](mailto:sheila.maclellan@sserc.org.uk)

Further information, including dates and details of how to register, will be distributed to schools and Local Authorities in August 2007.



### Support for Scottish Science Education through CPD

A partnership project sponsored and part-funded by the Scottish Executive

Information will be available shortly on the SSERC website: [www.sserc.org.uk](http://www.sserc.org.uk)



## No. 221 Summer '07

### Contents

- 2 Biology/Safety - Face masks (cover story)
- 2 Biology - Wonderful wizardry of finding a gene
- 4 Biology - Enzyme specificity - or is it?
- 5 Chemistry - Ion migration - copper(II) chromate(VI)
- 6 Science/ICT - Using tapeless video cameras in Science
- 7 ICT - Digital video cameras - a comparison
- 8 Physics - Back to the '70s with ammeters & voltmeters
- 9 Physics - Radioactive sources in schools
- 10 Physics - Obtaining an absolute measure of atmospheric pressure
- 11 CPD News - Advance notice of Heads of Faculty course and courses for teachers of Primary, Chemistry, Physics & Biology in support of a Curriculum for Excellence.
- 12 Annual Conference & AGM date announced.
- 12 SSERC Shop - surplus

## SSERC Annual Conference & AGM 2007

### Breaking down barriers

We are pleased to announce that the SSERC Annual Conference & AGM at the Glasgow Science Centre, Glasgow on 30th November 2006.

If you want to make sure of a place please contact *Sheila* on [sheila.maclellan@sserc.org.uk](mailto:sheila.maclellan@sserc.org.uk)

We hope to feature workshops as part of this year's programme. Keep an eye on the SSERC website for details.

The *SSERC Bulletin* is published by SSERC, 2 Pitreavie Court, South Pitreavie Business Park, Dunfermline KY11 8UB  
Telephone: 01383 626070 Fax: 01383 842793 E-mail: [sts@sserc.org.uk](mailto:sts@sserc.org.uk) Web: [www.sserc.org.uk](http://www.sserc.org.uk)

## SSERC Shop - Surplus

Prices do not include VAT. It will be added to your order. Schools will be able to reclaim this input VAT. Postage and packing, will be charged for. Please don't send cash with an order, but wait for us to bill you with an advice note then pay on that. Official orders may be used. Please order at least £10 worth of goods to minimise the proportion that is p & p costs.

- |   |       |  |       |
|---|-------|--|-------|
| 614 Miniature motor: 3 V to 6 V d.c. No-load current: 220 mA at 9600 r.p.m. and 3 V. Stall torque 110 mN m. Body: 30 mm x 24 mm dia. Shaft: 10 mm x 2 mm dia. ....  | 45p   | 690 MES lamp, 6 V, 150 mA.....   | 10p   |
| 593 Miniature motor: 1.5 V to 3 V d.c. No-load current: 350 mA at 14800 r.p.m. and 3 V. Stall torque 50 mN m. Body: 25 mm x 21 mm dia. Shaft: 8 mm x 2 mm dia. .... | 30p   | 866 Lens-end lamps, MES, 1.2 V.  |       |
| 621 Miniature motor: 1.5 V to 3 V d.c. Open construction, ideal for demonstration. Dimensions: 19 x 9 x 18 mm. 8-tooth pinion on output shaft.....                  | 25p   | 691 MES battenholder. ....   | 20p   |
| 839 Solar motor: 12 mm long by 25 mm dia. Shaft: 6 x 2mm dia. (see also Item 838 - solar cell).....   | £1.70 | 730 Battery holder: AA-type cell, holds 4 cells, PP3 outlet.....   | 20p   |
| 773 Tachometer (ex equipment).....  | £2.25 | 835 Battery holder: AA-type cell, holds 2 cells, PP3 outlet.....   | 15p   |
| 893 Zinc rods: Length 125mm, supplied packs of 10 (per pack)..  | £2.70 | 729 Battery connector: PP3 type, snap-on press-stud, also suitable for items 692 and 730. ....   | 5p    |
| 801 Propeller: 3 blades, each 62 mm. Fits 2 mm shaft .....  | 35p   | 358 Capacitor, electrolytic: 28 µF, 400 V.....   | £1.00 |
| 165 Bimetallic strip: Original type, length 10 cm. High expansivity metal: Ni/Cr/Fe - 22/3/75. Low expansivity metal: Ni/Fe - 36/64 (invar). ....                   | 15p   | 615 Thermocouple wire: Type K, 0.5 mm dia., 1 m of each type supplied: Chromel (Ni Cr) and Alumel (Ni Al); for making thermocouples, (Bulletins 158 and 165). ....   | £3.10 |
| 166 Ditto, but 30 cm length.....  | 40p   | 640 Disk thermistor: (substitute type) resistance of 15 kohm at 25°C, $\beta = 4200$ K. Means of accurate usage described in Bulletin 162. ....  | 30p   |
| 861 Bimetallic strip: (new type - won't rust after exposure to Bunsen flame, hence higher price) 10 cm length. ....   | 30p   | 838 Solar cell: 100 x 60 mm, 3.75 V per cell max.....  | £2.10 |
| 862 Ditto, but 30 cm length.....  | 80p   | 507 Optical fibre: Plastic, single strand, 1 mm dia. Applications described in Bulletin 140 and SG Physics Technical Guide Vol.1. Priced per metre. ....   | 50p   |
| 837 Ring magnet: 40 mm o.d., 22 mm i.d. ....  | 35p   | 508 LEDs: 3 mm, red. Price per 10. ....  | 50p   |
| 823 Ceramic block magnets: Poles at ends, 10 x 6 x 22 mm. ....  | 12p   | 761 Ditto, yellow. Per 10. ....  | 60p   |
| 723 Microswitch: Miniature, SPDT, lever operated. ....  | 40p   | 762 Ditto, green. Per 10.....  | 60p   |
| 354 Reed switch: SPST, 46 mm long overall, fits RS reed operating coil Type 3. ....   | 10p   | Light Shaping Diffuser - As described in SSERC Bulletin 216, page 6. Supplied in 35mm slide holder, two types:   |       |
| 738 Relay: 6 V coil, DPDT, contacts rated 3 A, 24 V d.c. or 110 V a.c... 75p  |       | 894 Elliptical cross-section beam. 40° x 0.5°.....   | £4    |
| 688 Croc clip: Miniature, insulated, red.....   | 5p    | 895 Round cross-section beam. 10°.....   | £4    |
| 759 Ditto, black. ....  | 5p    | 883 Convex meniscus lens: Focal length = 500 mm, dia. = 50 mm. APPLICATION: Demonstration of large scale, circular, interference fringes with laser radiation. Manufactured specially for SSERC with generous grant from EPSRC. .... | £7.00 |
| 789 MES lamp, 3.5 V, 0.3 A .....  | 10p   |  |       |

Latest Equipment Offers available online on the SSERC website :-  
<http://www.sserc.org.uk/members/equipoff.htm>