

# The Evolution Of Tower Clock Movements And Their Design Over The Past 1000 Years

Mark Frank



Copyright 2013

# **The Evolution Of Tower Clock Movements And Their Design Over The Past 1000 Years**

## TABLE OF CONTENTS

Introduction and General Overview	
Pre-History .....	1.
10 <sup>th</sup> through 11 <sup>th</sup> Centuries .....	2.
12 <sup>th</sup> through 15 <sup>th</sup> Centuries .....	4.
16 <sup>th</sup> through 17 <sup>th</sup> Centuries .....	5.
The catastrophic accident of Big Ben .....	6.
18 <sup>th</sup> through 19 <sup>th</sup> Centuries .....	7.
20 <sup>th</sup> Century .....	9.
Tower Clock Frame Styles .....	11.
Doorframe and Field Gate .....	11.
Birdcage, End-To-End .....	12.
Birdcage, Side-By-Side .....	12.
Strap, Posted .....	13.
Chair Frame .....	13.
Plate-and-Spacer, Strap .....	14.
Plate-and-Spacer, Integral Plate .....	14.
Flat Bed .....	15.
Flat Bed, Common Hybrids .....	16.
Other .....	17.
Modular .....	17.
Common Escapements Found in Tower Clocks	
Verge, Foliot using Crown Wheel .....	18.
Strob, Foliot using Pinned Wheel .....	19.
Verge with Long Pendulum and Short Pendulum .....	19.
Recoil, Anchor .....	20.
Deadbeat, Graham .....	20.
Deadbeat, Pinwheel .....	21.
Gravity, Dennison Double Three Legged .....	21.
‘Free’ Pendulum .....	22.
Types of Remontoire Used in Tower Clocks	
Overview and General Function .....	23.
Escapement, Spring style .....	25.
Gravity Train Remontoire	
Wagner, Swinging Frame .....	25.
Differential .....	26.
Epicyclical .....	26.
Robin, Endless Chain .....	27.
Verite, Rocker .....	27.
Gravity-Escapement type .....	28.

Striking Systems Used in Tower Clocks	
Count Wheel .....	29.
Rack and Snail .....	30.
Pin, Roller Pin .....	31.
Cam and Modular Cam .....	32.
Carillon .....	33.
Winding Systems Used in Tower Clocks	
Capstan .....	34.
Direct Winding Square .....	34.
Reduction Gear/Winding Jack .....	34.
Electric .....	35.
Stirrup .....	35.
Maintaining Power	
Endless Rope, Huygens .....	35.
Bolt-and-Shutter, Weight and Spring .....	36.
Spring, Harrison .....	37.
Epicyclical, Sun-and-Planet .....	37.
Typical Tower Clock Installations .....	38.
Exterior Views of Some Clock Towers .....	40.
Tower Clock Restoration Highlights .....	45.
Footnotes .....	51.
Photo Credits .....	54.

## The Evolution Of Tower Clock Movements And Their Design Over The Past 1000 Years

How many people here have a tower clock? - Probably very few.

Now how many have been personally involved in the restoration or maintenance of a tower clock? - Also very few.

This is reflected in the fact that compared to the numbers of domestic clocks, few tower clocks were made. These clocks were costly. Especially so when combined with the fact that they normally operated one or more bells and required a structure for the whole to operate within along with regular, skilled maintenance. Often the church or town that wanted to erect a clock had to levy a special collection or tax. Occasionally the clock would be a gift from the town's wealthiest family. Certainly a good PR move on their part!

The purpose of this discussion is to illustrate the evolution of horology through the various mechanical and physical aspects as represented in tower clocks. This is related to most other types of clocks in general as their development closely parallel each other.

The earliest surviving example of a geared device is the Antikythera Mechanism c.78 BC from Greece. It was a remarkably complex mechanism employing epicyclical gearing with an estimated 33 wheels. It demonstrated the existence of a highly developed Hellenistic tradition of geared instruments which was transmitted to and preserved in Arabic culture and, in turn, influenced the development of the Western European tradition of clockwork.<sup>1</sup> Surely simpler geared mechanisms existed much earlier, perhaps by a few centuries or more. Man had demonstrated long before the invention of the first clock a sophisticated mastery of the mathematics behind, as well as fabrication of, complex geared mechanisms. However, these machines did not have to contemporaneously tell time. In other words the gear trains were moved manually in order to mimic or predict the movements of the heavens. It would take another thousand years before the mediating mechanism needed to automatically move the gears trains was discovered, that is the *escapement*. Nonetheless just take a moment to study the complexity and subtle epicyclical gear interactions in this machine on the following page. The genius of those ancient peoples! No other evidence of such mechanical sophistication occurs until the construction of the St. Albans tower clock which was equipped with a planispheric astrolabe about 1330 - *over thirteen centuries later!*

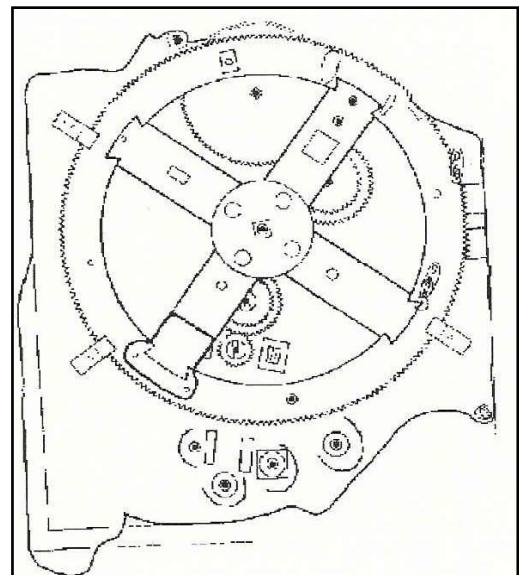
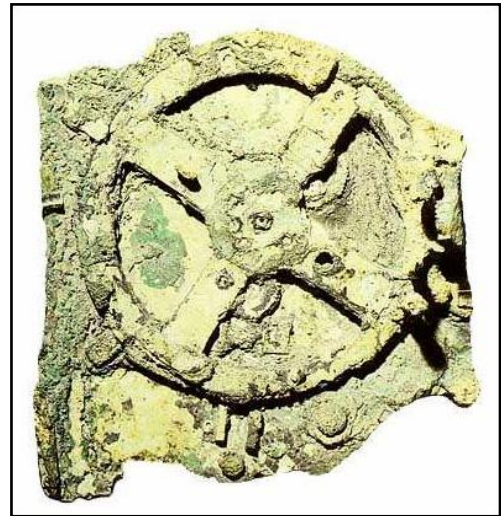



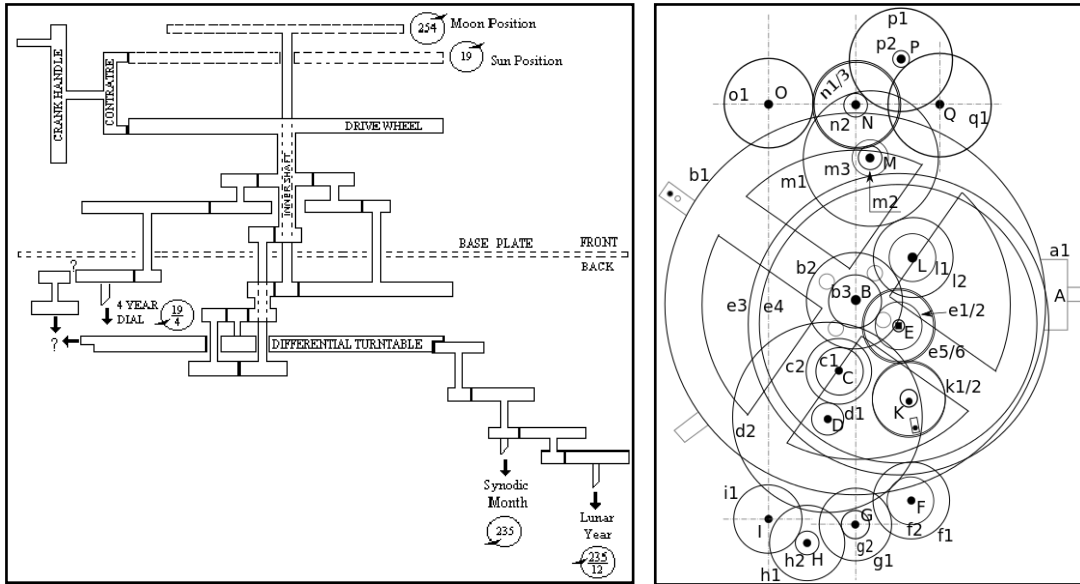

The gear diagram as well as schematic wheel layout shows the full ingenuity and complexity of this device. To the right is a modern reconstruction based upon forensic examination.

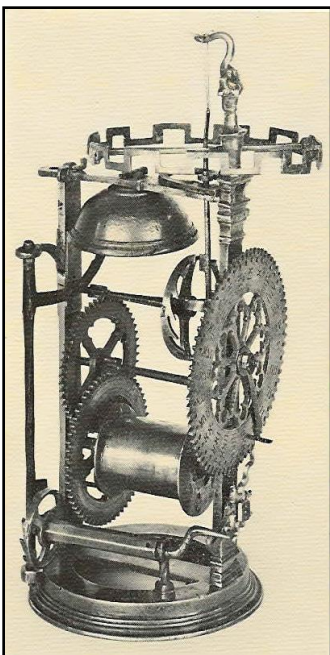
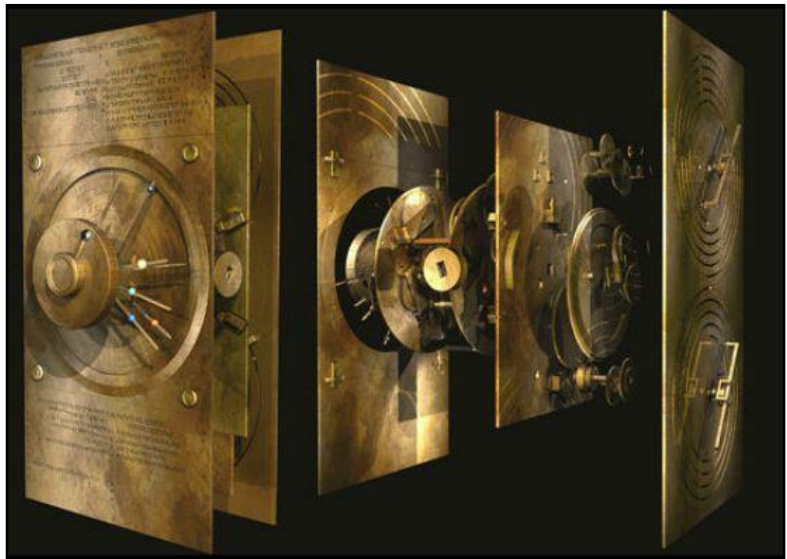

The first mechanical time piece probably appeared in Italy in the 10th - 11th century. Some credit Pacificus, Archdeacon of Verona (c. 880) while others credit Gerbert, a monk, who later became Pope Sylvester II (c. 996) with having the first mechanical clock. It was small; of wrought iron construction about ten inches high. It hung on the wall and used weights suspended on cords as its motive power. The escapement was that of a *verge / folio* design. The center arbor carried a rotating dial on which the hours were painted and moved past a fixed pointer. The dial also carried a ring of sockets into which the owner could put a peg. As the dial rotated the peg lifted a lever and sounded a bell at a predetermined hour. This was the forerunner of the humble alarm clock. Its purpose was to warn a monastery official to call the brethren to prayer by ringing the monastery bell.

The time keeping was poor - not much better than one half to one quarter hour per day. However the mechanical clock was an instant success. Although a novel and very expensive device it swept through the upper echelons of the religious and secular circles of Europe.

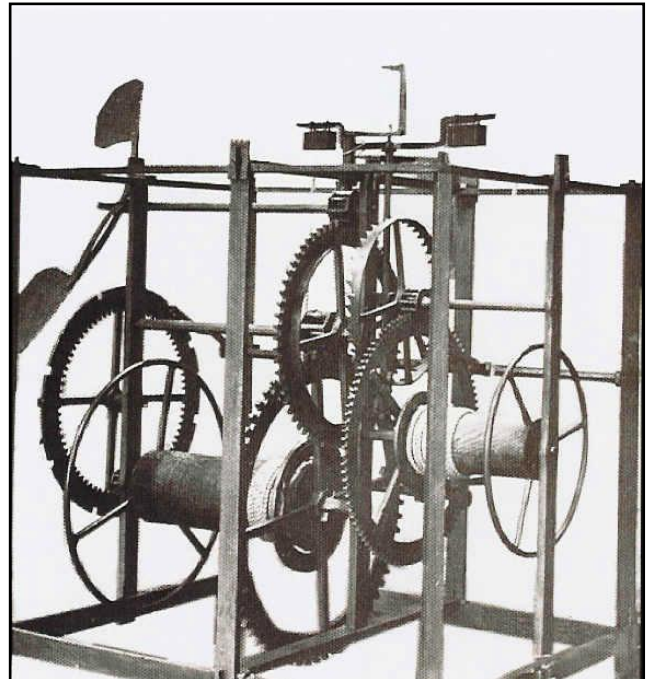
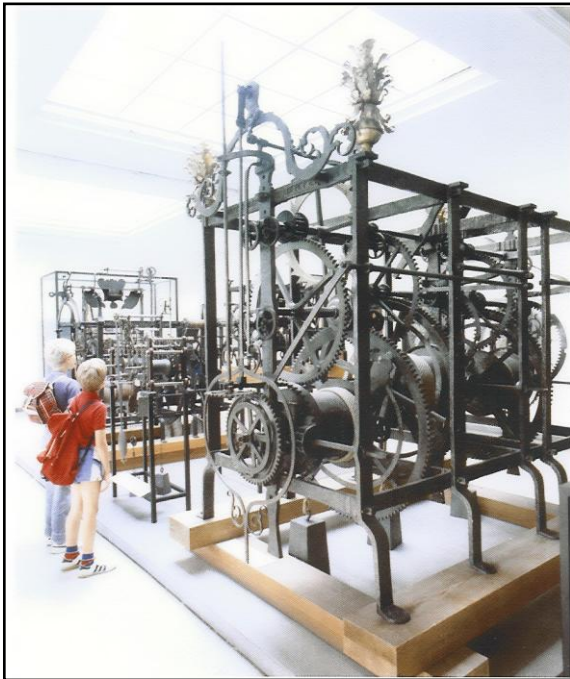

A number of developments followed in the next century. The size of the clock increased and this made possible the mechanism for striking a large bell with a number of blows representing the hours. When mounted in a tower to increase the audible range of the bell, the tower clock was born. A further development was the use of the clock for driving astronomical dials (the mechanics of which were well known centuries earlier) and automata (bell jacks). By the twelfth century exterior dial work became common.<sup>2</sup> The famous French clock maker Ferdinand Berthoud said in the mid 18th century "The first clocks with gear wheels controlled by a balance were intended for the use of the general public and to this end were placed in the belfries of churches and in public buildings so that passersby might know the time indicated by the dial and those who were further away could hear the clock sounding the hours". This succinctly sums up the purpose and nature of a tower clock.

A few such clocks from the mediaeval period continue in service. One of the most famous being the clock located in the Old Town Hall, in Wenceslas Square, Prague, Czechoslovakia. The first clock of the Town Hall dates back to the beginning of the 15th century. Clock maker Hanuš, who performed the construction of the second clock in 1490 was, according to the legend, made blind by the city council to prevent him from making a more beautiful clock elsewhere<sup>3</sup>. Most of the mechanism still used today is made by Jan Táborský between 1552 and 1572. It is unique in being the oldest of those where the original clockwork has been in operation from the beginning to the present time; nearly five centuries. Even the astronomical dial shaped like an astrolabe survives in the original form.

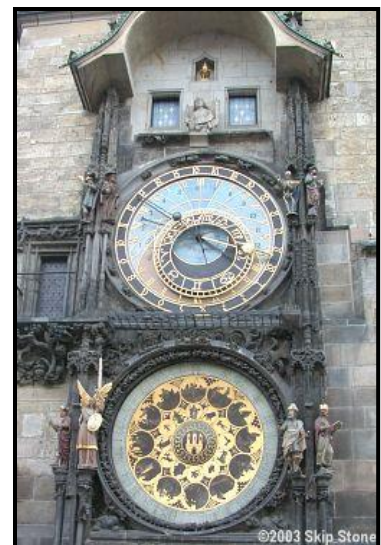





Until the 17th century few in the general public were aware of mechanical clocks other than the tower clocks found inside cathedral towers, monasteries, abbeys, and public squares.

Following is a brief outline of the development of the tower clock from the mid 1100's (12th century) through the mid 1900's (20th century).

**General construction and materials:**

The time line presented below is a rough generalization. It is most appropriate for *clocks made in major city centers* where the exchange of ideas; new inventions and techniques would be most rapidly adopted. In areas that were poorer and more rural, developments could lag by 100 to 200 years or more. This is especially the case in frame designs and materials.

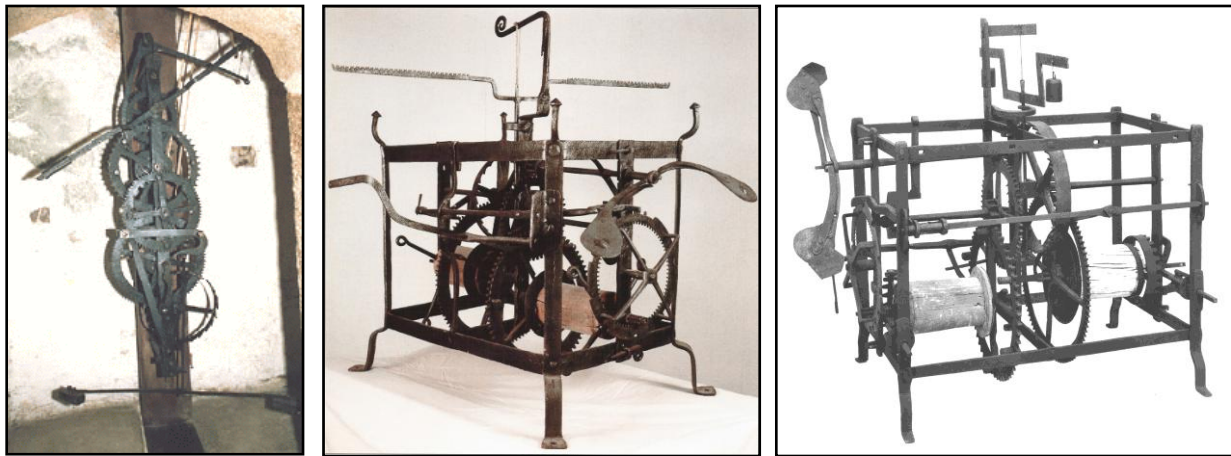

**12th through 15th centuries.** The earliest tower clocks were made of wood and shortly afterward of

wrought iron. The clocks were dictated by the material that the maker could obtain. Wrought iron was smelted by charcoal and forged into a flat bar. The bars were assembled into a rectangular framework using tenons and mortises to join them. The whole was held together with wedges; some points riveted. Screws did not appear until the 15th century. Upon this framework the pivot bars would be hung. The frames typically contained a great deal of space and aptly came to be known as *birdcage* frames. Bushes rarely were seen of a different composition than their surrounding material. Clocks built during this period lasted approximately 80 years.<sup>4</sup> The use of a *foliot, verge and crown wheel* dictated the need for a support in the middle of the clock and the end-to-end arrangement of the trains was a suitable one. This style persisted well into the 18th century. In the latter 15th century brass began being used for bushing material.

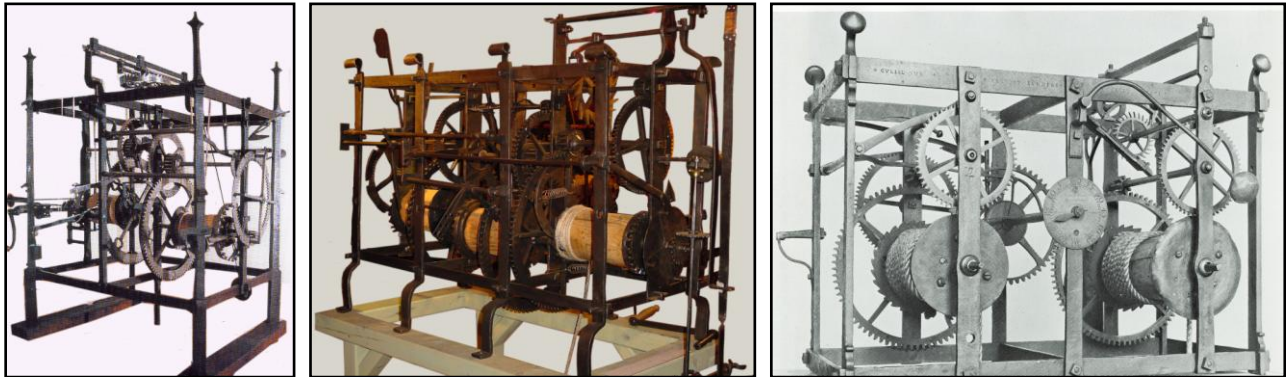

**16th through 17th centuries.** In the 16th century some of the better makers began using brass for their wheel works. The event of singular importance was the application of the pendulum to clock work by Christiaan Huygens in 1656\*\*. This brought the clock from a machine for curiosity to being a fairly practical timekeeper. Less than a decade later the *recoil escapement* came upon the scene. The configuration of the recoil escapement made it more convenient to arrange the train *side-by-side* and generally, but not always, at the same height. The pivot bars were now fixed to the long side of the rectangular frame and not the short side as in the end-to-end design. One of the pivot bars was often used to support the pendulum. The improvement in timekeeping was so great that nearly all clocks, both tower and domestic types, were converted. Sometimes the trains were turned from end-to-end to side-by-side. In other cases the pendulum hung from the short side of the clock. Screw threads were easier to make by the end of the 17th century. While screws were used in specific circumstances as early as the late 15th century, by this time clock frames were generally held together with nuts. Also by this time it became usual to add a third pair of pivot bars centrally between the going and strike trains. This carried the arbor with a wheel mating with the going train and turning around once per hour. The rear of the arbor drove the lead off work, the front carried the setting dial. It also carried the means for letting off the strike thus keeping the hands and strike in step which is necessary on count wheel types of striking, and which we will see in the section on strike work. A friction clutch or release-able coupling between the going train great wheel and the control hour arbor enabled the clock keeper to set it correctly to time. Before this the escape pallets were able to be slid out of alignment with the anchor and the movement allowed to 'free wheel' to the correct time. This often resulted in accidents of the escape wheel and / or pallets being damaged when contacting each other during this process. Or the train itself becoming damaged when allowed to run faster than it was designed for - a.k.a. a 'runaway'.

A spectacular example of this type of catastrophic event occurred to the Westminster clock a.k.a. Big Ben on August 5, 1976 at 3:45 AM. The hollow tube that connected the fly fan mediating the speed of the chime train fractured. When the chime was initiated it quickly gained speeds far in excess of its design limit; rapidly accelerating from its normal speed of 1 RPM to 1600 RPM and literally blew itself apart. Fortunately the room was unoccupied at the time of the accident.

\*\*Conflicts as to attributions of inventions are more fully explored in later sections and their footnotes.



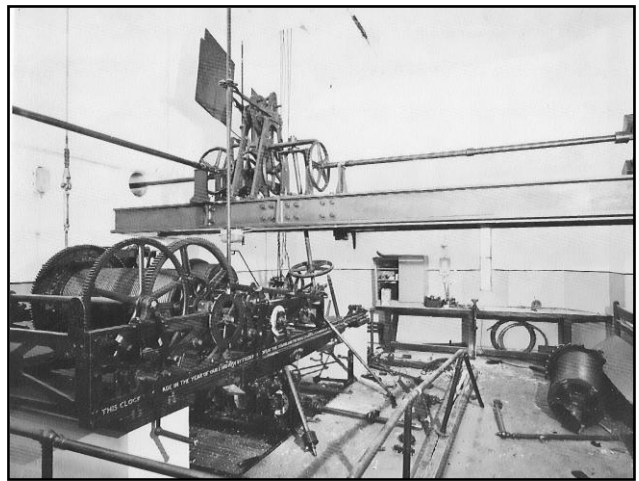
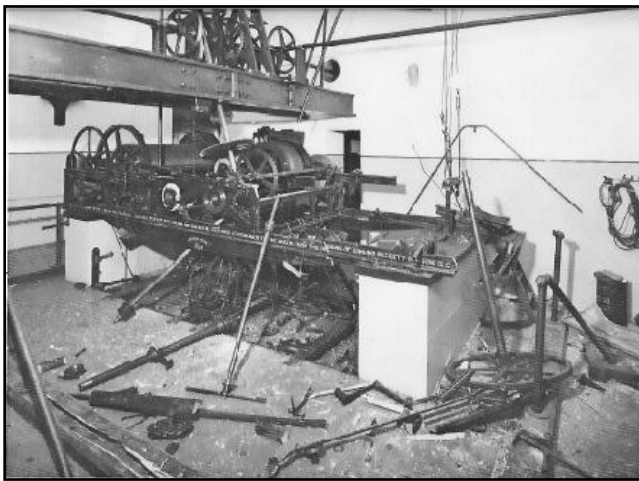
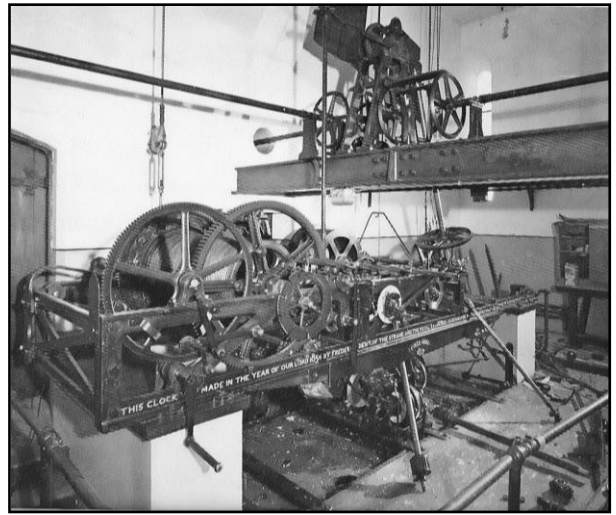
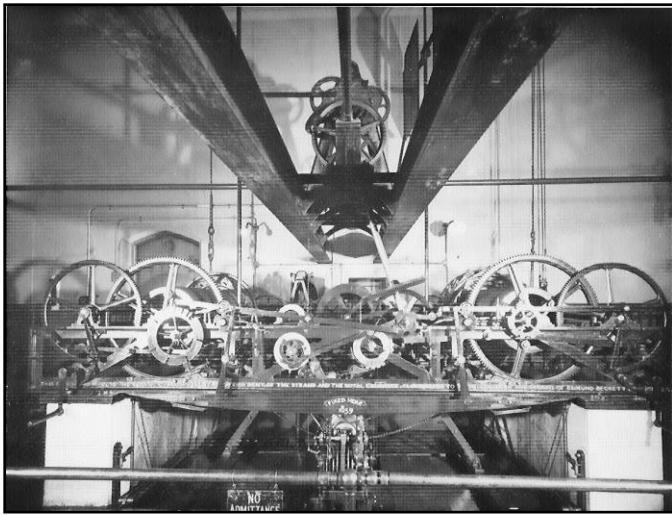

The first photo shows the clock in tact before the accident, the last four, after. The heavy frame was fractured in five places and it was fortuitous that it was not so weakened as to allow the remaining time and hour strike weights to pull the entire mechanism into the weight pit. Had this occurred, it is unlikely that the clock could have been salvaged. These were the first pictures taken, before anything was moved. Notice how the force of the energy released stripped the movement of nearly all chime parts. Remember that this force was supplied by the uncontrolled decent of a 1 1/4 ton weight. The heavy chime barrel weighing more than 1/2 ton itself was hurled across the room smashing into the wall; coming to rest upon the observer's bench. Fortunately the clock room wall was nearly three feet thick so it was able to stop the drum, otherwise it would have continued through the wall to fall against the glass of the dial and crash to the ground 180 feet below. The fly fan was snapped off. Heavier pieces of gearing, weighing up to ten pounds had been driven clean

through the thick timber ceiling. Virtually all of the chime mechanism was smashed and scattered over the clock room floor in small pieces. The time train which was next to the chime train suffered considerable damage from shrapnel; the hour strike train somewhat less. The white walls of the room had been peppered with metal fragments as if from a fragmentation bomb. Indeed, the first thing that the Control Engineer did when he saw the devastation was to call the bomb squad thinking it had been a explosive device that had caused the damage.<sup>5</sup>

The bench in the last photo looks as if it could easily seat four people. Compare this to the size of the drum.

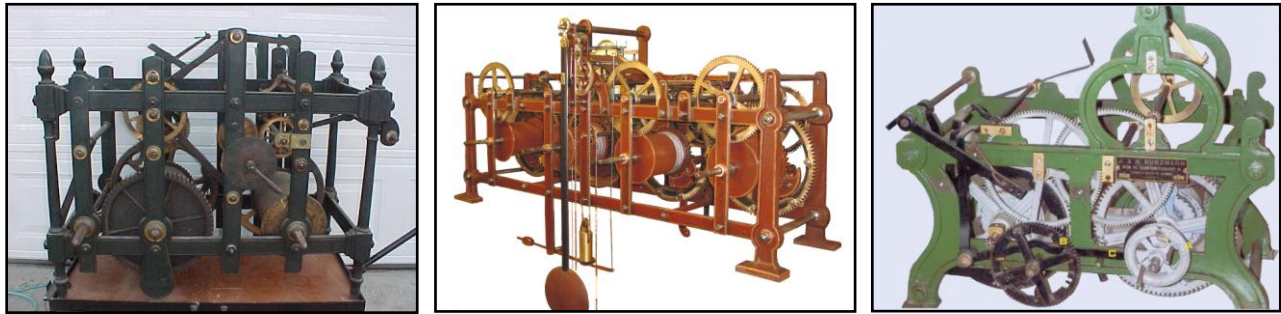

18th through 19th centuries. As the recoil escapement was perfected in the late 1600's the improvement in performance made a hand indicating minutes practical and it appeared in domestic clocks in the early 1670's and so the clock became the ubiquitous item we know today <sup>6</sup>. The second hand did not come into general use until the middle 18th century and then only in domestic clocks. During this time and through the early 18th century most tower clocks equipped with the previous verge / pendulum setup were converted to recoil. The minute hand became a common feature on tower clocks by the middle of the century. For some tower clocks this would be their second conversion i.e the third escapement system (folio with crown wheel, pendulum with crown wheel, and finally pendulum with anchor)! A significant event was when George Graham of England improved upon the *deadbeat escapement* in 1730 and the *pinwheel deadbeat* was invented in 1741 by Armant of France. These became the most widely used escapements in tower clocks. And remain in use in many mechanical clocks to this day.

The next significant development was the wide spread use of cast iron in the 18th century. Cast iron, invented in China in the fifth century B.C and was first made practical in Europe by Abraham Darby, of Coalbrookdale, England in 1709. He discovered how to smelt iron ore with coke and developed the process that required a special type of furnace through which a stream of air could be forced (hence the term blast furnace). This produced temperatures high enough to liquefy iron completely. The molten metal could be run into molds and thus set into complex shapes.<sup>7</sup> The cupola furnace, again invented in China c.300 BC was simple and scalable. Small furnaces using the Darby process were capable of making cast iron in small batches and brought the use of this material to a wide area of both England and the European continent. By the middle 18th century these furnaces were in most towns allowing for the widespread production of cast iron.

Toward the end of the 18th century tower clock makers began to adopt the new material. Being conservative by nature, they used the new material to make clocks similar in design to those that had

been before with wrought iron bars. This is reflected in the cast iron four poster a.k.a. the *strap frame - posted* (see section on frame designs). In this case there was a massive cast iron frame made in separate pieces and bolted together to carry the cast iron pivot bars.

A clock of this design, properly maintained can last for well over two centuries. Decoration was limited and appears as molding and finials on the corner posts. In due course, the makers found that they could cast their the pivot bars integrally with the side frame. The two frames were held together

with spacer bars and bolts resulting in the *plate and spacer* frame. Removable pivot bushes, invented by Benjamin Vulliamy, made assembly and servicing easier. This frame style became quite popular by the middle 19th century due to the fact that pivots could now be located anywhere within the area of the frame.

A certain similarity appears between the clocks of various makers. In England the clocks of Moore and Sons are nearly indistinguishable from Thwaites and Reed - indeed Moore apprenticed at Thwaites before starting his own firm. In France the clocks of Cretin, Freres and Odobey are all very similar. In Germany it was Horz, Weigel, Holzoder, then Schneider, Lindner, then Ungerer, successor to Schwilgue and Mader, (the last French). It appears that many makers bought their parts from either competitors, or the same materials dealers and foundries. Where were the patent laws? Apparently these did not apply to the general appearance and construction!

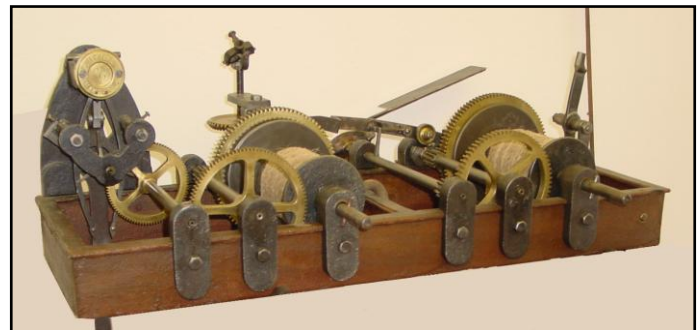
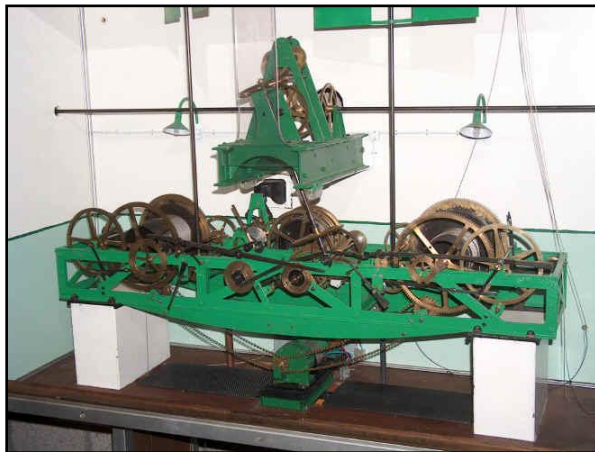

The final frame style, the *flat-bed*, came to the fore in the middle of the 19th century and made popular by the huge clock at Westminster, London - Big Ben. The width of the frame spans 16 feet with no center support! Edward Dennison (later Lord Grimthorp) is credited with designing the frame in the shape of a shallow rectangular box without a top or bottom piece. By making the frame deep enough and using an angled cross section, the frame is very strong and rigid. It is likely that Grimthorp was familiar with the contemporary bridge builders and their designs of the day. Those engineers were also using cast iron in the manufacture of beams; developing cross section profiles in the use of structures which were, by necessity, designed to be strong and rigid. He also perfected the gravity escapement and a single cast piece for the lifting of bell hammers, the *modular cam lifter*, (see section on striking systems).





The design of the flat-bed was quickly joined with the plate and spacer to produce the most prolific frame style used for larger and multi-trained tower clocks. In some cases the strike trains remained as a flat-bed arrangement with a plate and spacer frame for the going train. In others the entire set of trains were plate and spacers set upon the flat-bed frame.

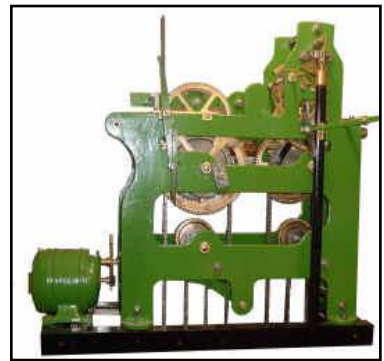
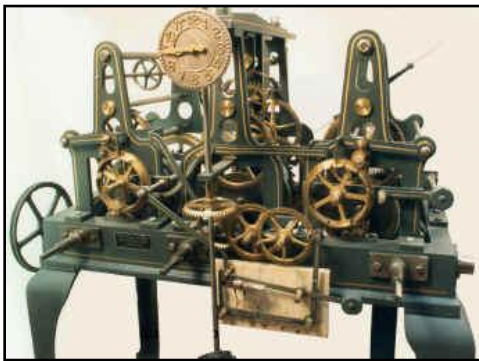

20th century. The flat-bed was the culmination in the design of tower clocks and along with that of the plate-and-spacer continued up until World War II. Thereafter the manufacture of purely mechanical tower clocks virtually ceased. For a brief period of time between the 1930's through the middle of the 1950's a few companies, particularly those in Germany, made tower clocks that were mechanical in every sense, but wound electrically through the use of complex epicyclical / worm gearing. These were marvelously complex devices since they could be wound manually as well as electrically. Another type, used in the United State as represented by Seth Thomas and E. Howard dispensed with the conventional winding barrel and substituted a geared wheel. This was connected via a continuous looped chain to weights that were periodically raised by an electric motor. Usually there was no provision for manual winding and thus were simpler systems.

In the first half of the 20th century, many tower clocks were severely violated. Instead of proper maintenance the movements had their escapements removed and replaced by motors; often in a non-reversible, crude fashion. Barring this they were scrapped. Today, if one looks up at a clock tower and sees the dials properly functioning, they are most probably being driven by a small synchronous motor behind each dial. These are electrically synched together by a master control which is often tuned via radio or satellite to the country's time standard. These also will automatically adjust for Daylight Savings Time and are equipped with backup power in the event of an outage.

It is sad to see the general extinction of these huge denizens of the horological world. Like the dinosaurs, the world changed around them and they could not survive. Mechanical tower clocks, compared to a synchronous motor, need much attention. There is the weekly winding (unless converted to electrical winding). Professional periodic inspection and maintenance is expensive. And as with all things mechanical, the occasional repair and replacement of parts can be very expensive. In some areas of Europe, England is a case in point, the government tries to help owners of tower clocks - churches in particular - keep their movements from falling into destitution.



Fortunately there are a few owners of towers with clock movements in the United States that now see their worth. These lucky movements have either been restored to full mechanical function as originally designed. Or, as is more often the case, are equipped with an electrical winding system that does no violation to the original mechanism and is fully reversible. Hopefully this trend will continue. Also there are a few collectors who try to preserve, restore and care for these clocks until the time comes for the next generation to assume that responsibility. Much of the author's collection can be seen at [www.my-time-machines.net](http://www.my-time-machines.net).

Now let's turn to the individual parts of the tower clock and their development in more detail.



## TOWER CLOCK FRAME STYLES

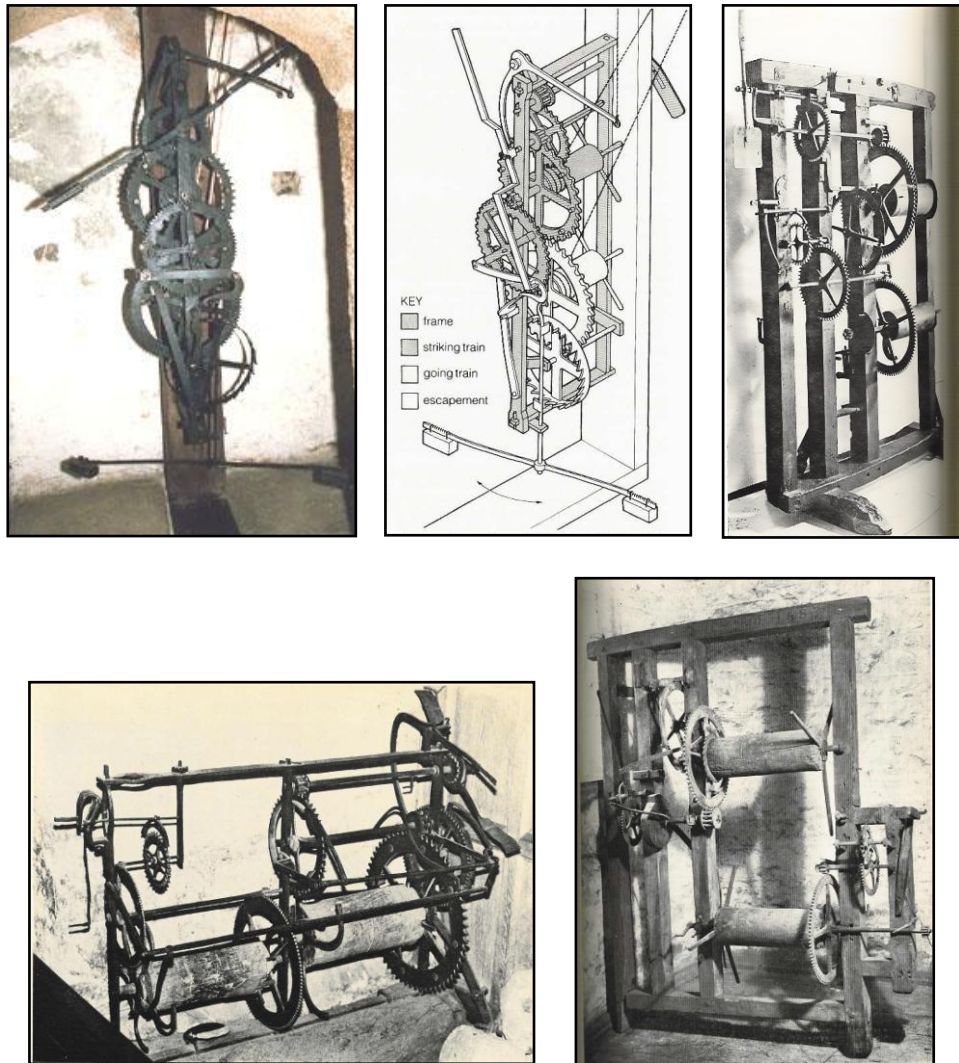

### **DOORFRAME and FIELD GATE.**

These styles may or may not have been developed before the birdcage end-to-end but so few examples exist that the evidence is unclear. They are certainly a more primitive layout, and the evolution of the design to the caged frame is logical.

In the *doorframe* the two trains were located one above the other or one beside the other on a single pair of vertical pivot bars. Most of these clocks had a wooden frame but occasionally they were made of wrought iron. This example of wrought iron dates from the 13th century and is one of the very few clocks that retains its original foliot and verge. Notice the verge hangs in an inverted position at the bottom.<sup>1</sup>

You can see the evolution from the doorframe's single frame leg supporting the two movements one above the other to the movements being supported between two similar frame pieces. This is known as the *field gate* design. This concept for holding clockwork continues through to today.<sup>2</sup> The second example of field gate shows further development toward a true birdcage design. Here the movements are still supported by single, vertical pivot bars (now three), but have evolved into the familiar end-to-end movement appearance seen in the later caged designs.<sup>3</sup>

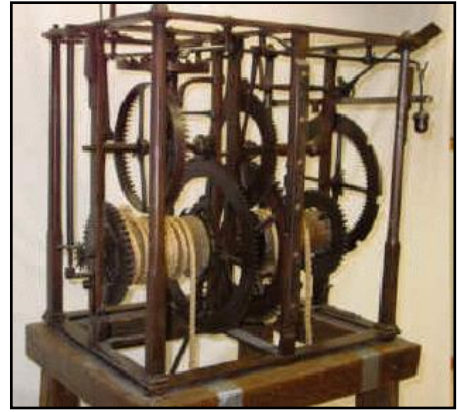
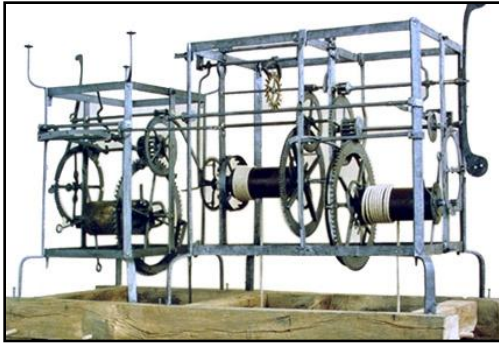

### **BIRDCAGE - End-To-End.**

This design is used in the earliest known clock (with a conformable date) at Salisbury Cathedral, England, 1386. However drawings and descriptions exist of this form as far back as the 1100's. Most clocks of this type were originally equipped with foliot escapements. Material was almost always wrought iron but some examples were made of wood. Wedges and/or riveting were used to secure the frame parts together. Vertical bars which carry the pivot holes are secured by wedges. A distinguishing feature is the 'empty look' of the movement within the frame vs. latter styles. This type lasted until the latter 1600's. The invention of the recoil escapement around 1666 began the decline of this design.

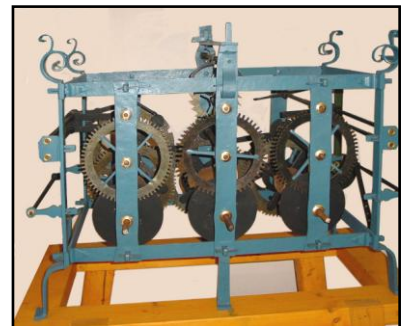
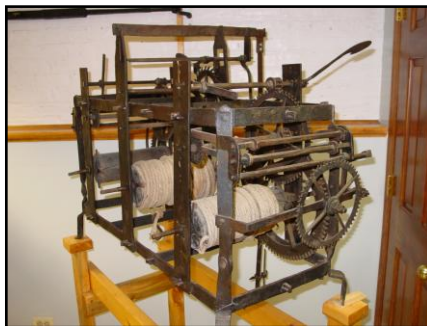

### **BIRDCAGE - Side-By-Side.**

This style came into use after the introduction of the recoil escapement. (There was, of course, an overlap of many decades, and in rural areas - a century or more - in the years between this and the end-to-end-style). Again the frame is held together by a combination riveting, wedges and threaded nuts with more of the latter being employed as time went on. Vertical bars are also removable to facilitate construction and servicing. About that time most clocks were being converted as well as all clocks currently being built to the newly invented recoil escapement. This type lasted until cast iron superseded wrought iron toward the end of the 18th century.



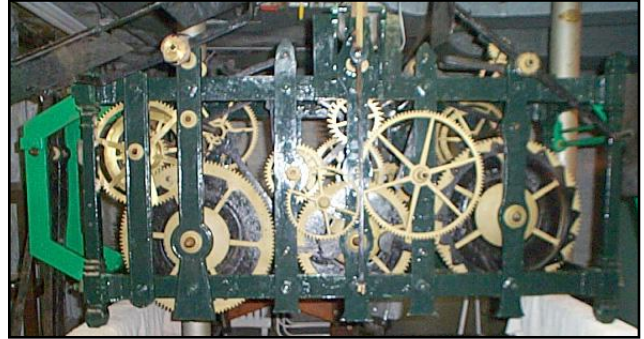
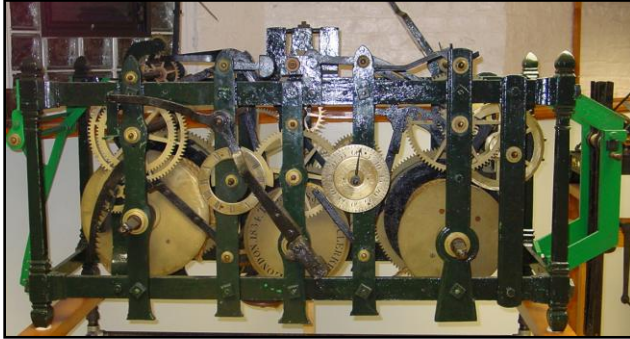

**POST FRAME - strap.**

This style became popular after 1790's with the increasing availability of cast iron and lasted until 1850's. All of the frame parts are made of cast iron, usually the corner posts are round or square. Generally the parts all bolt together. Usually the entire end frame is cast as one piece.

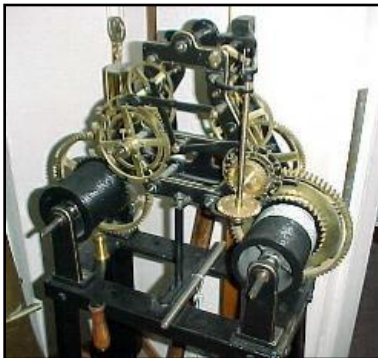

**CHAIR FRAME (also known as DOUBLE frame).**

This is a double frame construction comprising a narrow frame for the wheel trains and a wide frame for the barrels. Tower clocks are subject to heavy loading; long arbors are susceptible to damage. In this way maximum strength is obtained within the wheel works due to shorter arbors. While the wide frame allowed for long barrels. This allowed for many turns of the line increasing duration of the clock. The style enjoyed popularity for about 100 years between 1730 to 1840. Henry Handily of England is credited for this innovation.<sup>4</sup>

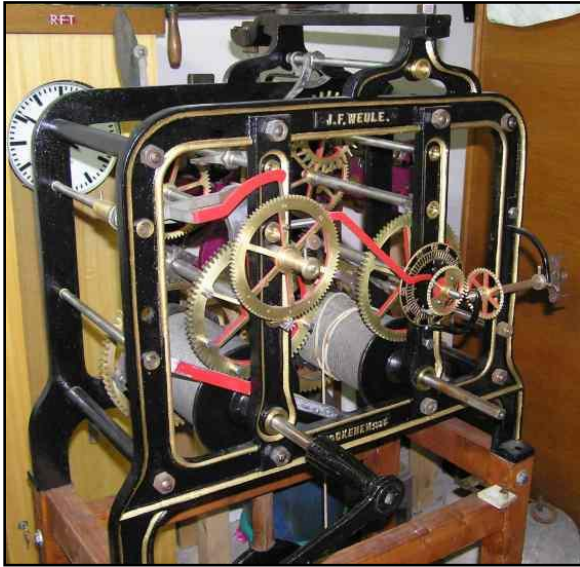

**PLATE-AND-SPACER frame - strap.**

Still made of cast iron, this design was even easier to make than the strap framed type. here the frame comprised two cast iron plates, one front, one back. These were held apart by several pillars (spacers). Vertical train bars were removable in the normal way, again secured by nuts. This became popular around 1800 through 1850, but continued to be used past that date on smaller clocks.

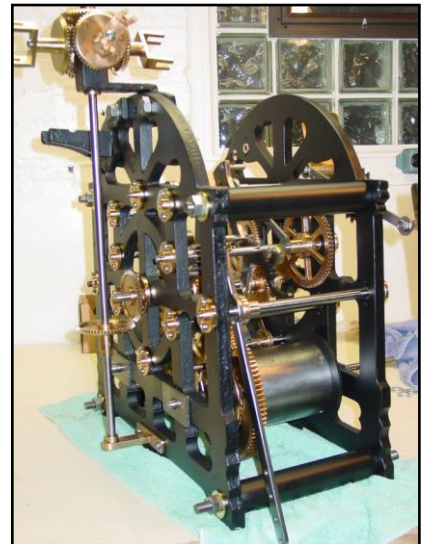
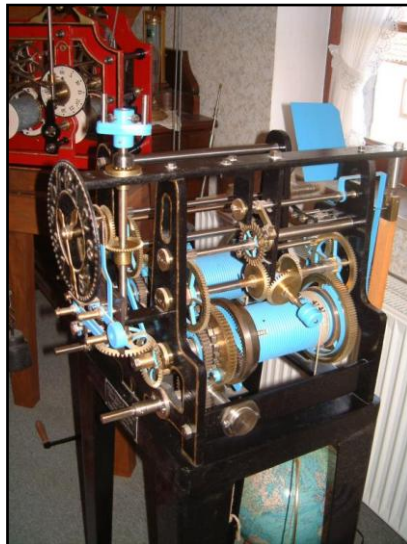

**PLATE-AND-SPACER frame - integral plate.**

Same as above except the entire clock movement is held within the two cast iron plates. The concept is similar to that used in a conventional clock movement. Its main advantage is that it allows flexibility in the placement of the movement wheels anywhere within the frame; dispensing with the verticality made necessary by pivot bars. This style was used mainly on smaller tower clock movements for the obvious reasons of the difficulty in casting and maneuvering a large heavy piece. Furthermore, unless removable bearings are used (which increases cost) it becomes very difficult, not to mention hazardous, to service a clock with such large plates. This style was used from the 1850's through the 1940's.



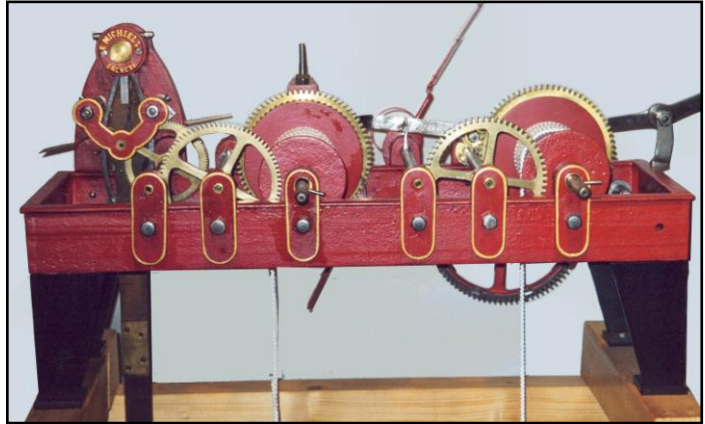

### **FLATBED frame.**

Perhaps the earliest cast iron flatbed was made by Benjamin Vulliamy in 1827.<sup>4,5</sup> The design became popular around the 1850's. 6. The frame is in the shape of a shallow rectangular box without a top or bottom piece. By making the frame deep enough and using an angled cross section, it is very strong and rigid. The upper surface of the flat bed frame was used as a base and wheel bearings were then bolted onto this. Ideally it was possible to remove any wheel without disturbing another, but in reality this was seldom achieved. The reason is that a true flat bed design entails a very wide clock bed, especially for a complicated movement as would be the case in a three train quarter chiming clock. This becomes a costly and more difficult issue with regards to installation and space requirements. The movement at Westminster a.k.a. Big Ben is the most famous cast iron, true flat bed movement. Completed in 1854, it has a single free span of 16 feet and is 5 1/2 feet deep; weighing 5 tons. The consequence of wider spans results in more robust designs leading to greater weight.

Another design advantage is that the reaction forces between wheel and pinion are vertical and can to some extent be balanced out. Consequences of wear in the pivots are more forgiving as the change in the depth of engagement between the wheel and pinion changes to a lesser degree.

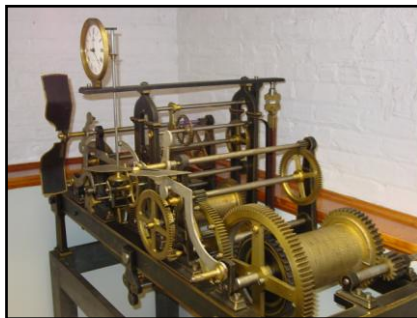





**FLATBED - Common hybrids (bottom of prior page and above).**

Most medium to larger tower clocks built after the 1860's were a hybrid type of flatbed / plate and spacer style. The reason for this was the fact that true flatbeds required a very wide profile making them more impractical and expensive. In the case of hybrids the time train was often in a plate-and-spacer frame mounted to a flatbed frame with the strike trains laid out in a true flatbed fashion.

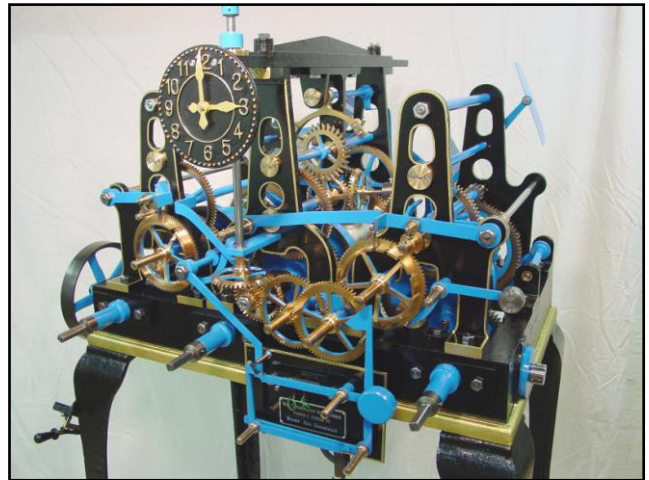

Some are merely one or more plate-and-spacer type frames mounted together on a flatbed frame and could hardly be called a flatbed in any true sense, though they commonly are. This type of flat bed arrangement was anticipated as early as the mid 1700's by French maker Pierre Le Roy where he used brass or wrought iron bars dovetailed together to make the bed. The trains, were a birdcage styled end-to-end design and placed upon the bars. Each train was independent but the wheels within each train were not, same as the examples shown above.<sup>4</sup>

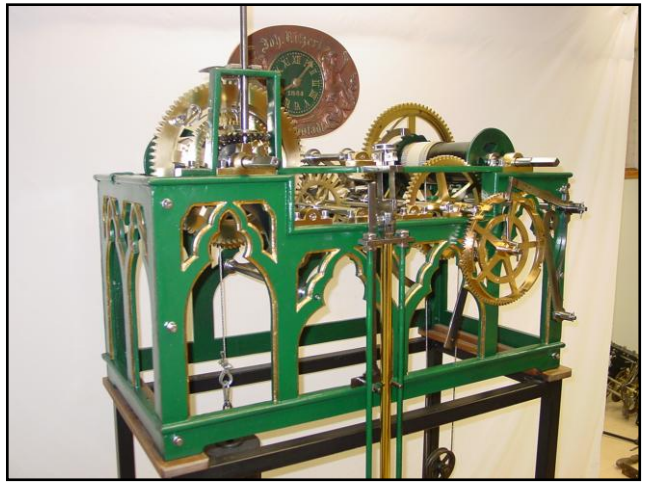

**OTHER.**

Some clocks do not fit into any particular style. Left, a flatbed base with three unsupported frames (no spacers). Right, the frame is made up of four plates bolted together to form a 'box'.

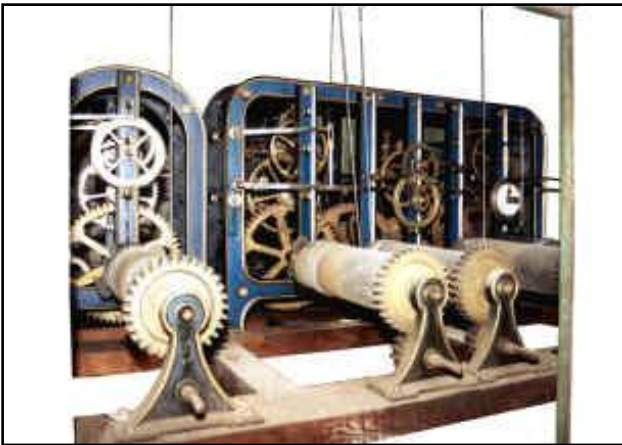

**MODULAR.**

Still others have used a particular frame style, but divide a clock that strikes into separate frames. This modular design gave flexibility in manufacture, transportation and installation. It was favored by a few makers, especially in Germany. Some American makers used this too, Van Riper (who was a German immigrant), Stone and Marshall (also associated with Van Riper).



## ESCAPEMENTS USED IN TOWER CLOCKS

The history of escapements and indeed most of the developmental efforts in the field of horology was and is the quest for greater accuracy in timekeeping. This is well illustrated in the evolution of the common tower clock escapements.

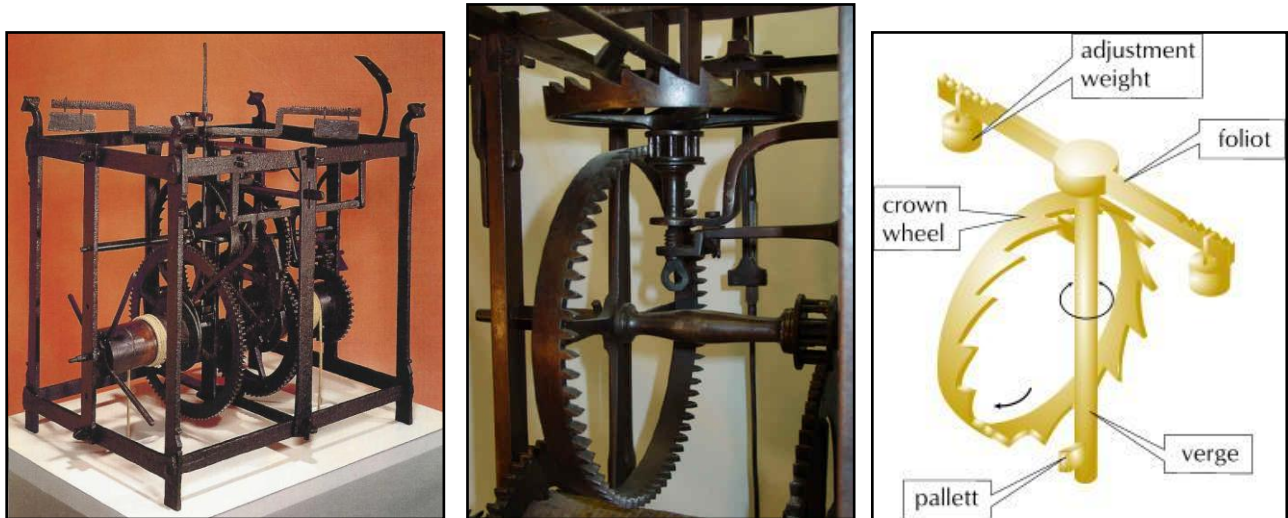

### **VERGE var. FOLIOT using CROWN WHEEL (above).**

This was the earliest type of escapement used on mechanical clocks. Documents show this type was known since the 1100's, the oldest surviving example in a tower clock of certain date being that from the Salisbury Cathedral, Wiltshire, England. 1386. These were primitive, hard to regulate and very poor time keepers. Few examples of tower clocks exist with their original foliot intact. Even the famous clock at Salisbury was converted from foliot to a recoil escapement sometime in the 1700's. It was restored to its original escapement style in 1956 by John Smith & Sons before being put on display as the oldest surviving, dated, and largely complete clock in the world. The best accuracy that this escapement could get was one quarter hour per day.

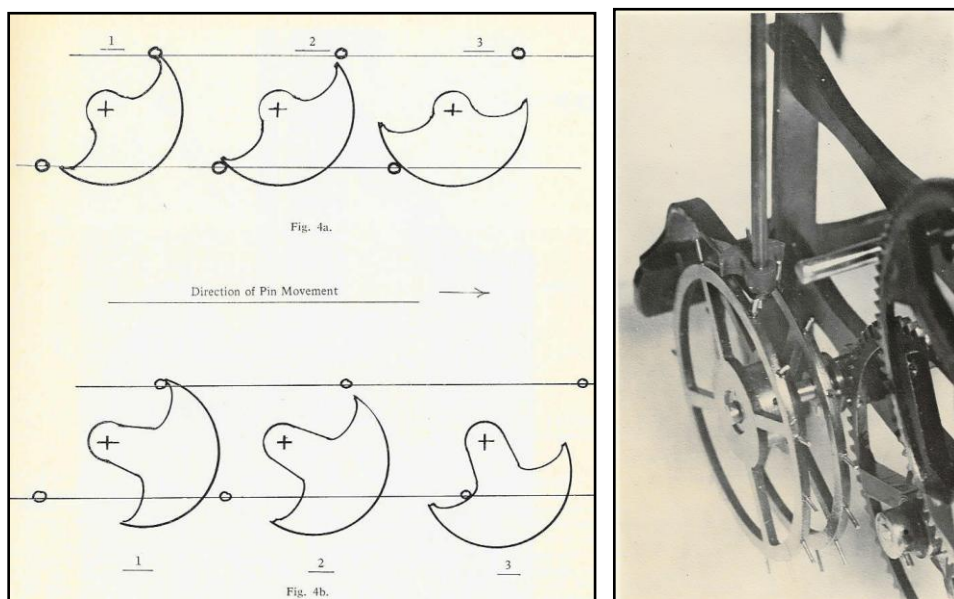

Strob escapement (left) and diagrammatic operation. See next page for discussion.

**STROB var. FOLIOT using PINNED WHEEL (picture previous page).**

No examples of a tower clock using this escapement survive. However a tower clock with this escapement along with a sophisticated planisphere astrolabe was commissioned by the abbot Richard of Wallingford and installed in the St. Alban's Abbey around 1330's.<sup>1</sup> A detailed description of this tower clock exists and a miniature copy along with the planisphere astrolabe was successfully made in 1976.<sup>2</sup> A full sized version of the tower clock was later made and displayed at the Time Museum in Rockford, Illinois.

**VERGE and introduction of the (long) PENDULUM.**

The history of the application of the pendulum to clockwork is well known. But briefly the basic highlights are that Galileo Galilei in Italy noticed in 1582 the characteristic timekeeping property of the pendulum in that its period of swing was almost independent of its amplitude; shortly before his death in 1642 he designed a pendulum clock. His son Vincenzo shortly before his own death in 1649 took up this work and almost completed the clock. The drawing, made by Viniani, a friend of the Galileo family in 1659 shows this almost completed clock. Nonetheless, Christiaan Huygens in Holland; probably without the knowledge of Galileo's work, introduced the pendulum to regulate a mechanical clock on Christmas Day 1656. (It was a holiday so he had some spare time to experiment!).<sup>3,4</sup> This was a vast improvement upon the folio bringing the best accuracy down from one quarter hour to about one to a few minutes per day, but still involved the verge (and crown wheel) with its inaccuracies. The earliest conversions involved the use of very long pendulums in an effort to match the very slow rate at which the conventional foliot escapement beats. The first such conversion of a tower clock was done by Mr. Huygens and his clockmaker Salomon Coster in 1658 at Scheveningen near the Hauge. These early conversions are known as Scheveningen conversions. The pendulums reached 20 to 30 or more feet in length. This method seems to have been mostly limited to Holland.<sup>5</sup>

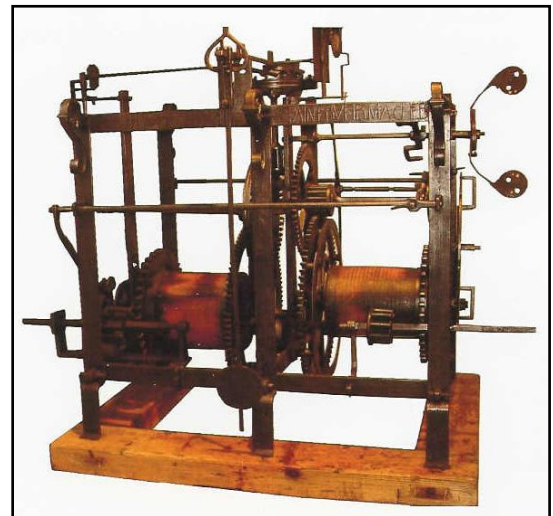

**VERGE and SHORT PENDULUM (above & right).**

In England and elsewhere on the continent the crown wheel was turned 90 degrees to a horizontal position and driven by a contrate wheel from the rest of the movement. This allowed for a much shorter pendulum, but still involved the verge (and crown wheel) with its inaccuracies and a wide arc of vibration in the range of 85 degrees. Tower clocks were fitted with this as well as the long pendulum escapement for a short period between 1658 and 1690.



### **RECOIL a.k.a ANCHOR.**

The invention of this escapement c. 1666, was initially credited to Dr. Robert Hooke. However it is now thought that William Clement or maybe Joseph Knibb was the inventor. The first documented example is seen in Joseph Knibb's Wadham College, Oxford tower clock, 1670. But it is generally agreed that William Clement invented this escapement with his earliest example seen in the King's College, Cambridge tower clock, 1671. Its advantage over the verge is both in accuracy as well as ease of manufacture. Arc of vibration was reduced to about 5 to 10 degrees. Accuracy was improved further to one to two minutes per week. The addition of the minute hand became a practicality. In fact, improvement was so dramatic that nearly every clock was converted. Another reason for the sweeping change was that the conversion from the verge system to recoil was easier than the prior conversions from foliot to pendulum. All one needed do is replace the original vertical verge, or in the case of a horizontal verge, both the verge and contrate wheel with the recoil wheel. This design also brought about changes in the way the trains were laid out leading to the demise of the end-to-end birdcage frame in favor of the side-by-side design as was previously mentioned in the 'frame styles' section.

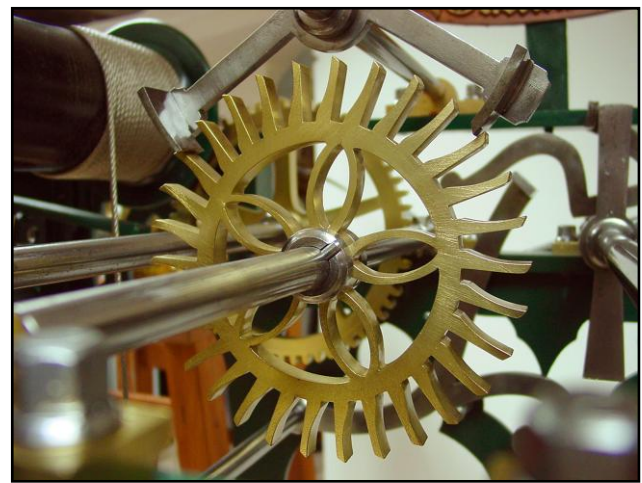

### **DEADBEAT (var. Graham Deadbeat).**

The deadbeat was first made by Thomas Tompion to a design by Richard Towneley in 1675. The example shown here is one most familiar to us, invented about 1715 by George Graham, one of England's eminent clock makers. This escapement is called a deadbeat because when the wheel tooth drops on the locking pallet face, however far the pallet moves, the wheel remains unmoved, as distinct from a recoil which moves a bit backward (recoil). This is the most commonly used escapement in tower clocks made by a wide variety of manufacturers in many different countries but favored in England and the United States. It's popularity due to its combination of relative ease of manufacture, reliability and accuracy. Arc of vibration was further reduced to 1 to 2 degrees. Best accuracy was further increased to less than a second a day.



### **DEADBEAT (var. Pinwheel).**

Invented by Richard Townely, 1675, but improved upon by Louis Amant about 1741. The design we are most familiar with was designed by Jean-Andre Lepaute in 1753 and remains in this form today.<sup>6</sup> Favored in French tower clocks, but also seen in English and other Continental tower clocks. Many clocks that had been converted or manufactured with the recoil escapement were again converted to pinwheel by the simple expedient of driving the pins into the periphery of the existing anchor escapement wheel and substituting the anchor for the pinwheel pallets. Not pretty but another example of 'whatever works'!



### **GRAVITY (Dennison double three-legged type).**

This type of escapement is in a class sometimes called 'remontoire escapements'. It should be noted that this definition is different from that of the type of remontoire we will be exploring in the next section. Those remontoire operate as constant force devices independent of the type of escapement they are powering. They contain their own auxiliary power supply in the form of weight or spring, and if the main weight is removed, the escapement will continue to be powered until the remontoire is ready to cycle. Typically 30 to 60 seconds. On the other hand, remontoire escapements operate as part and parcel of the escapement itself. So if the main weight is removed the escapement will cease to be powered on the next swing of the pendulum.

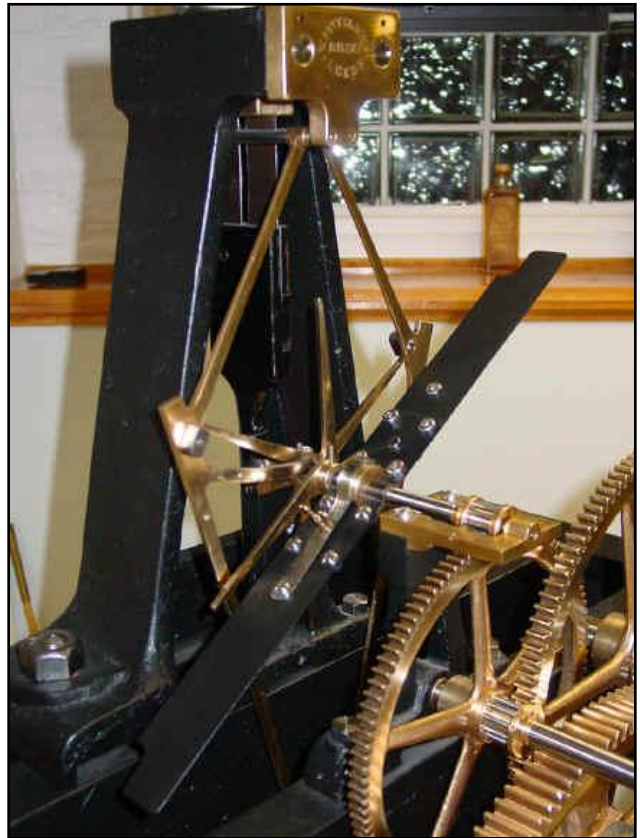

They are distinguished from all the prior escapements since the impulse is not given to the pendulum directly by energy from the main weight through the clockwork, but by some other small weight lifted up, or small spring bent, always through the same distance, by the clock train at every beat of the pendulum. Some also work on every other beat, leaving the pendulum free one half the time. This allows the pendulum to be largely detached from the rest of the clock. Many illustrious makers had tried to perfect the gravity escapement - Berthoud, Mudge, Cumming, Hardy. Bloxam had come close in 1853. All of these prior attempts suffered from various problems, chief amongst them the fact that the pallets had tended to bounce off the escapement locking surface; known as 'tripping'. Edward Dennison (later Lord Grimthorpe) perfected the gravity escapement in 1860 by eliminating the tripping problem.<sup>7</sup> He did this through the connection of a fly, a.k.a. an air brake, directly to the escape arbor via a friction clutch. It



allows the fan to advance slightly after the escapement engages the pallet. The inertia provided by the weight of the fly keeps the escapement seated against the pallet during locking; in essence acting as an 'energy sink'.<sup>8</sup> This escapement provides a nearly detached pendulum from the rest of the clockwork and is particularly important in tower clocks where wind and weather can cause disruptions to the movement through the exterior hands. Another special feature of this escapement is that there is no sliding friction on the impulse and so it does not need oil. Again, due to the environment in which tower clocks are found oil contamination is a problem; severe temperature changes can cause oil to thicken and thin beyond their normal intended characteristics. Because of these features afforded by the gravity escapement, the use of a train remontoire is rarely seen in conjunction with it. While there was some improvement in accuracy over the deadbeat escapement, its real virtues lie in its stability, the design's ability to keep the pendulum largely detached from the rest of the train, and the lack of need for oil. This escapement is seen largely in clocks from England.

The negative characteristics are the fact that it is a 'power hog'. The escape wheel arbor rotates  $1/6^{\text{th}}$  of a revolution per pendulum swing compared with  $1/30^{\text{th}}$  for a standard recoil or deadbeat escapement - a fivefold loss. This is even more severe in the case of a 4 legged escapement, ( $1/4^{\text{th}}$  revolution) - a 7.5 fold loss. There is usually the need for an extra wheel in the train or a very large wheel ratio - say a very large great wheel. Both of these solutions involve extra manufacturing expense. The escapement itself is also more expensive due to the number of parts used as well as the more complicated fabrication processes needed in manufacture as compared to a standard deadbeat escape wheel.

**'FREE' (intermittently pulsed), (right and top of next page).**

These types of escapements are seen on tower clocks from Germany. Actually, the example on the following page does not use a remontoire at all. It impulses the pendulum only once every 30 seconds leaving the pendulum to run completely free of any interference 96.7% of the time. It was invented by Joseph Mannhardt, Germany in c.1850. The pendulum never performs a locking function. Notice from the drawing the small ratchet wheel near the apex of the pendulum frame assembly. Every full cycle of the pendulum results in the ratchet being advanced one notch. Two pins located on the wheel 180 degrees from each other trip the release mechanism for the impulse cylinder to drop upon the pendulum rod's contoured rail at precisely the correct point for impulse. That impulse is delivered directly from the main weight. So while there is no remontoire supplying its own auxiliary power, the pendulum is isolated from the rest of the movement for nearly the entire time which is the first function of a remontoire. This system has no escape wheel in the normal sense of the term since there





is no locking or impulse between the pendulum and an escape wheel. When properly set up it is extremely stable. It rivals or surpasses the accuracy and reliability of the gravity escapement. In addition it is very efficient compared to the gravity escapement; by a factor of 5:1. The negative aspects are its high cost to produce, difficulty in setting and adjusting and expert maintenance.

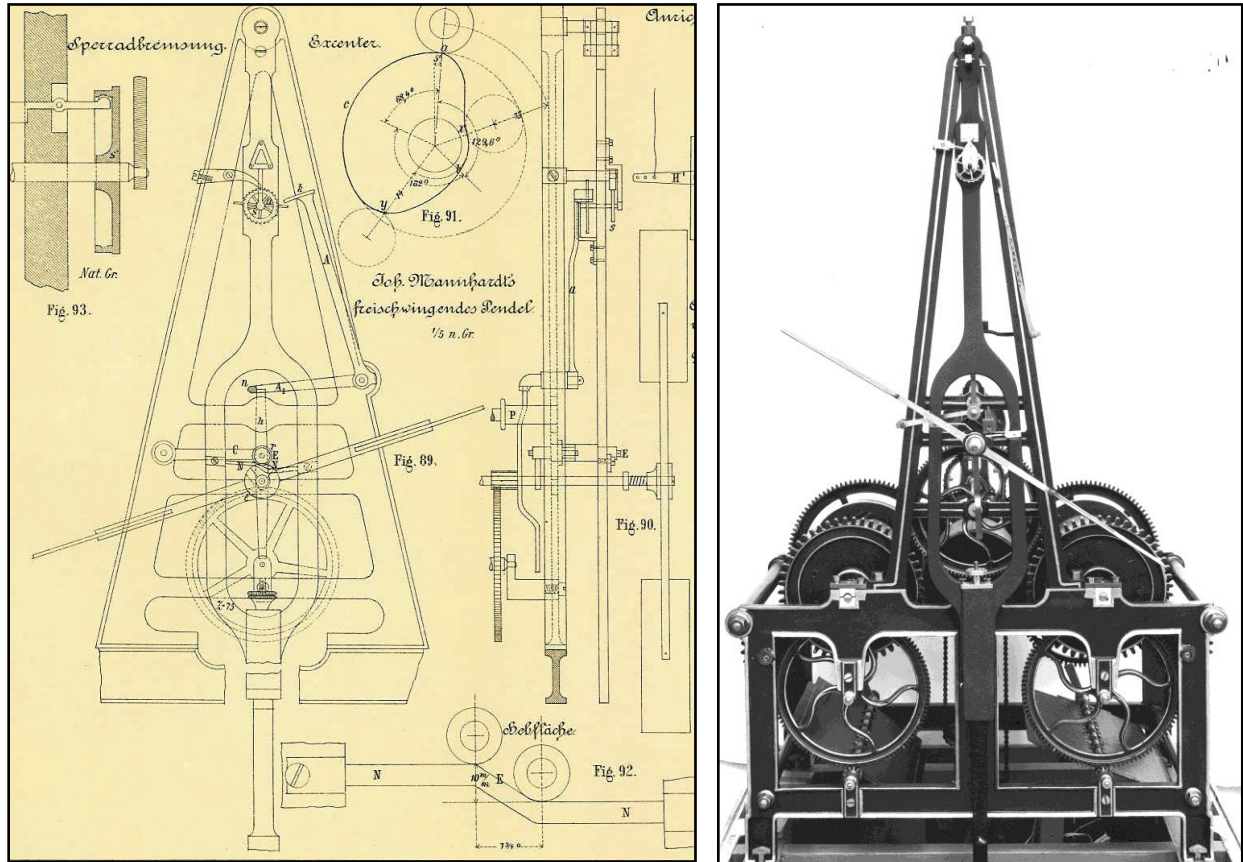

### SOME TYPES OF REMONTOIRE USED IN TOWER CLOCKS

Over the past 400 years or so many devices have been invented to provide a constant driving force for a balance or pendulum controlled timekeeper. Those for balance controlled movements, generally watches, reached pinnacles of mechanical art and complexity as demonstrated in the work of Harrison, Breguet, Hardy, Thiout, etc.<sup>1</sup> We will limit this discussion to those used to drive pendulum controlled tower clocks.

Remontoire is from the French word 'remonter' which means "to wind". It is a constant force device used in a timepiece whereby the main source of power periodically winds a spring or lifts a weight by equal amounts and at equal intervals to drive the timepiece's escapement. This device should not be confused with the term 'constant force escapement or remontoire escapement' which was discussed in the prior section on escapements.<sup>2</sup> The purpose of a remontoire in a tower clock is twofold. *First is to mechanically isolate the escapement from the rest of the movement.* This prevents variations and stoppages that might occur due to the environment that a tower clock must operate. Wind and weather such as ice and snow acting upon the large clock

hands on the outside of the tower will be transmitted back through the linkages toward the movement, through the wheel train and to its escapement. There are also the irregularities caused in the train by the release at intervals of the heavy striking and chiming trains, calendar or astronomical indicating mechanisms. *Second is to supply a smooth, constant source of power to the escapement.* Large seasonal temperature variances as well as environmental contaminants will cause differences in oil viscosity throughout the wheel train and is multiplied as the number of wheels and linkages increase. A remontoire alleviates this by isolating the escapement from the rest of the movement and keeping the number of wheels relevant in driving the escapement to a minimum.

Most tower clocks do not have a remontoire as this device added to the expense of manufacture and required more careful and experienced personnel to maintain. They are generally more fragile and subject to derangement than a simple going train movement. To overcome the above mentioned difficulties most makers went the route of brute force by employing heavier weights and robust wheel trains; an alternate, but less elegant solution.

Remontoire come in a wide variety of mechanical styles, and complexity. They can generally be divided into two categories. The first and earlier type is the gravity style. It was invented by Jost Burgi, Swiss (b.1552-1631), circa 1595 first applied in his Experimental Clock No. 1. He is also known for his invention of the cross-beat verge escapement. These innovations made his clocks the most accurate mechanical timekeepers of their day.<sup>3</sup> This type uses a small weight to drive the escapement indirectly, usually the next wheel, but direct escape drive is known. The second is spring style. It also was invented by Burgi about 1615 and was used in his Vienna crystal clock, considered his masterpiece effort. Here a small subsidiary spring is used as the motive of power to the escapement which, in turn, is kept wound at frequent intervals by the main movement spring or as was the case in Burgi's clock, every quarter hour through the action of the strike train. The subsidiary spring is normally attached directly to the escape wheel in tower clocks, but may be further down the train in smaller movements as was the case in Burgi's clock.

Each of these styles can operate as a train or escapement type. However in the majority of cases where employed in tower clocks gravity remontoire operate as train remontoire and spring remontoire operate as escapement remontoire. Both spring and weight styles are periodically rewound or lifted by the main time weight or occasionally by the striking train. The remontoire has also been used in some domestic clocks to overcome the problem of diminishing power being delivered to the escapement as the main spring unwinds. The main spring will drive a gravity remontoire effectively combining a spring driven clock and its advantages of portability, with a weight driven clock and its advantage of a constant force of gravity; in addition to isolating the escapement from the rest of the movement. Alternatively a fusee was commonly used to overcome the spring problem. It was much simpler and cheaper but not quite as accurate.

A clock equipped with a remontoire is fascinating to observe, as there is a periodic movement of the rewind mechanism and this is usually mediated by a fly fan (air brake) that spins around. The cycle can vary from as little as one second (rarely found and then only in watches) to one minute or more. The most common being 30 seconds and one minute.

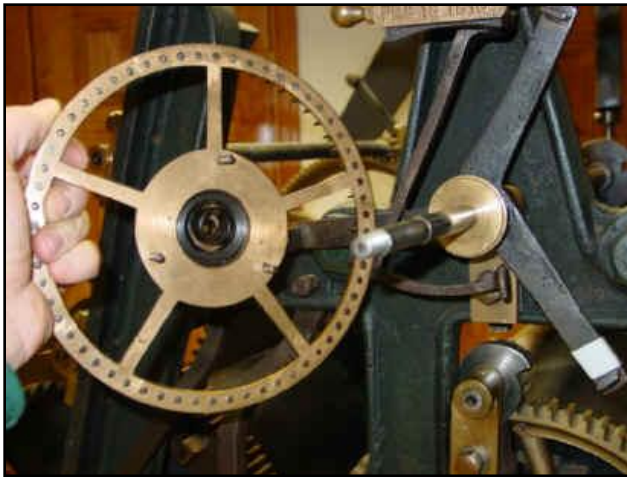

**Escapement style spring remontoire:** Basic design by John Harrison, but this is a patented version by Mathias Schwalbach.<sup>4</sup>

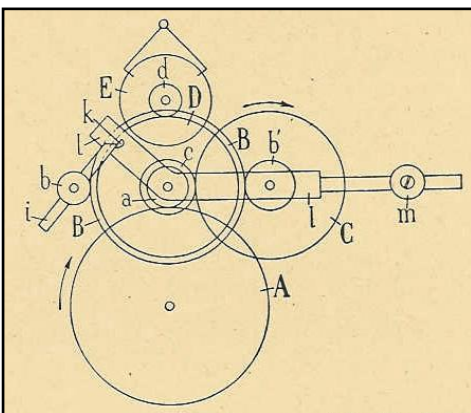
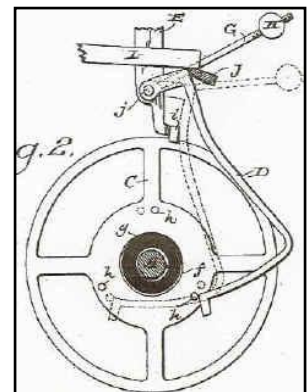
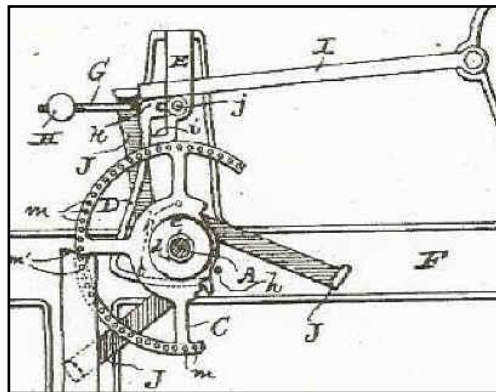

**Gravity train remontoire:** Sometimes referred to as 'swinging frame'. Bernard-Henri Wagner (uncle to Jean Wagner, c. 1850).<sup>5</sup> Animations of this type of remontoire are at this link:

[http://www.my-time-machines.net/wagner\\_remontoir.htm](http://www.my-time-machines.net/wagner_remontoir.htm)  
<http://www.my-time-machines.net/augustin.dcr>



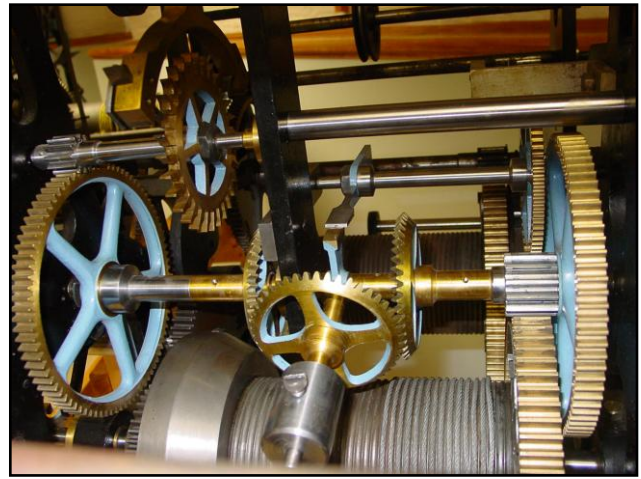
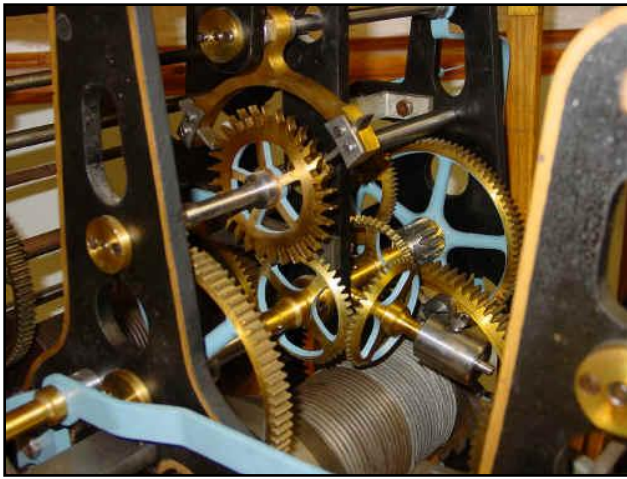

**Gravity train remontoire: Differential.**<sup>6</sup>

Attributed to Augustin Lepaute d/b/a Henry Lepaute, France. c. 1830. Seen primarily in German-made clocks. It is one of the more simple and efficient gravity types. An animation of this type of remontoire is at this link:

[www.my-time-machines.net/korfhage\\_remon-toire1.htm](http://www.my-time-machines.net/korfhage_remon-toire1.htm)

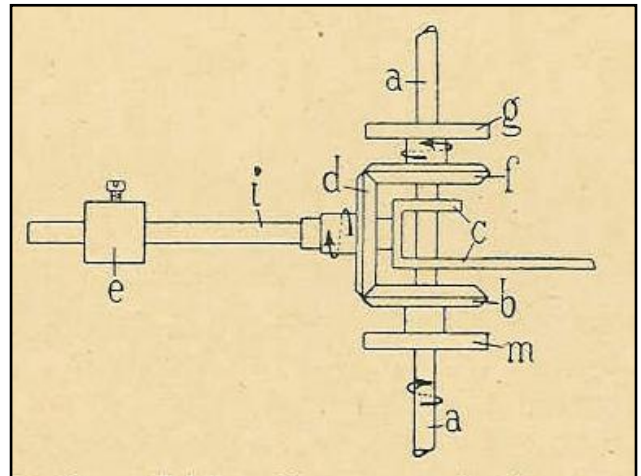

**Gravity train remontoire: Epicyclical (planetary gear).** George Biddell Airy, England. c. 1860.

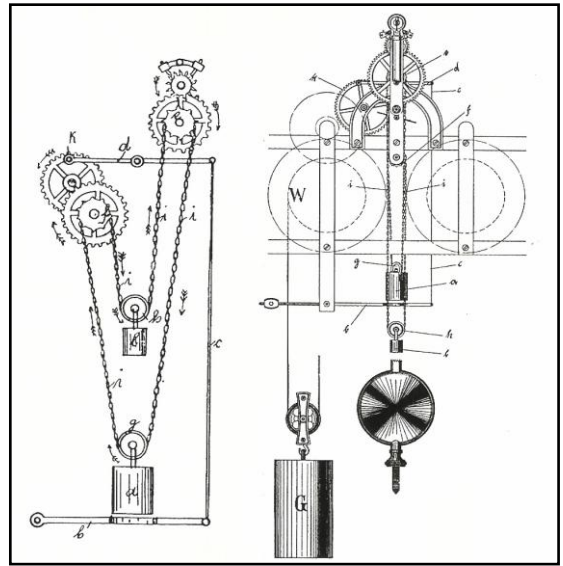
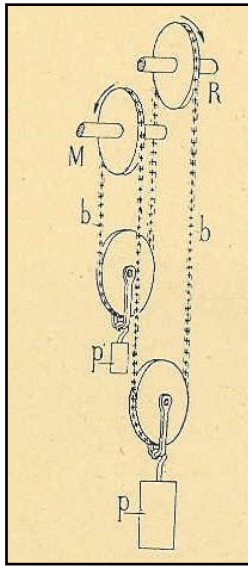

**Gravity train remontoire: Endless chain design.** Robert Robin, France, 1772; based on earlier maintaining power design by Christiaan Huygens, Holland, 1658. (center diagram).

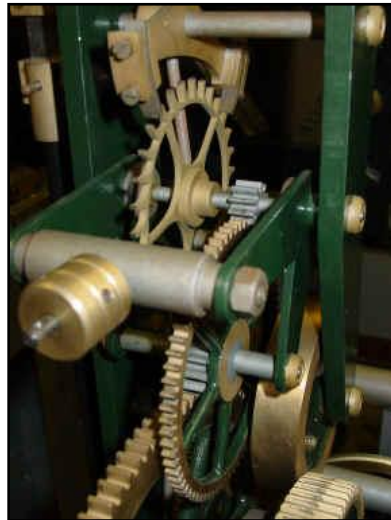
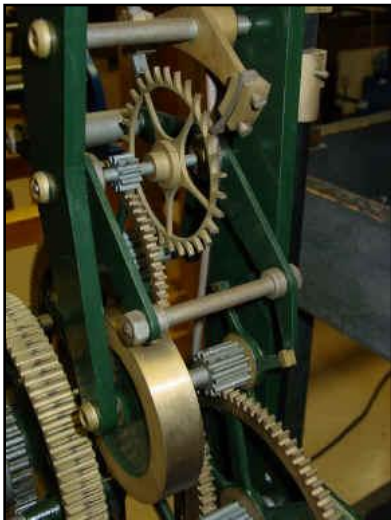

**Gravity train remontoire: Rocker.** Auguste-Lucien Verite, Beauvais, France. c. 1840.

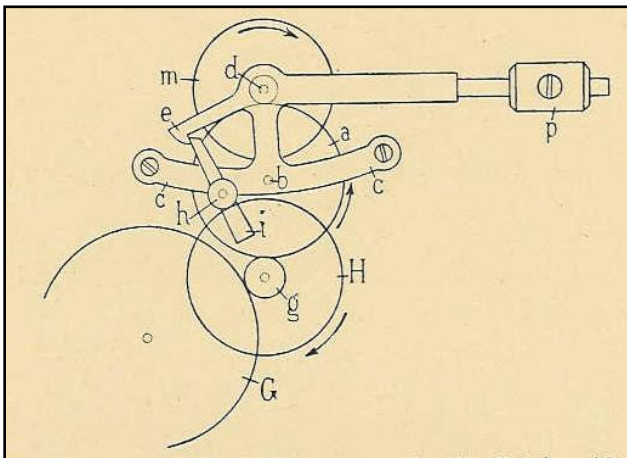



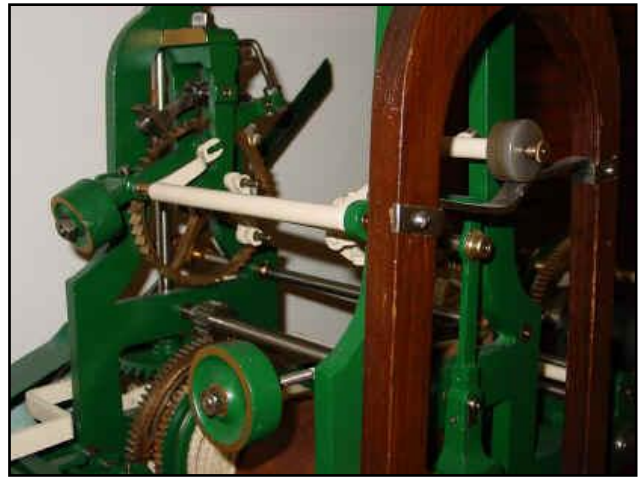

**Gravity type *escapement* remontoire:** This is the only example I know of that incorporates a gravity remontoire that operates directly on the escapement wheel. This is accomplished through the use of two types of joints in place of a conventional escape arbor. One a normal universal joint and the other an expansion style joint, probably invented by George Seybold, Germany.

[http://www.my-time-machines.net/seybold\\_detail.htm](http://www.my-time-machines.net/seybold_detail.htm)

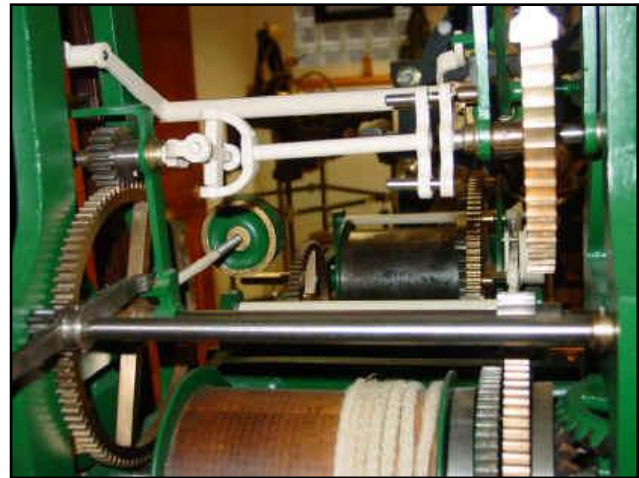

### STRIKING SYSTEMS USED IN TOWER CLOCKS

The earliest account of a clock with an hour strike, that is something that indicates via a bell contemporaneously the time the clock is telling, is in 1283. The system used is unknown. Another account is given in 1352, however both were unreliable.<sup>1</sup> Until the late 14th century we have several accounts of tower clocks failing to operate properly and having their bells rung manually.<sup>2</sup>

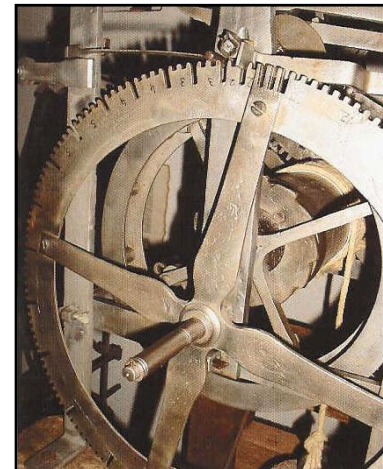
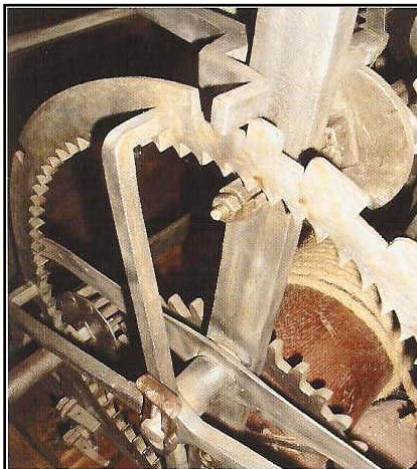

**Count Wheel (internal or externally toothed) a.k.a Locking Plate (British nomenclature) and contemporaneous strike control. (bottom prior page).**

One of the earliest ways for a clock to be able to reliably count off the desired number of blows on a bell was introduced sometime in the second half of the 14th century through the use of the count wheel.<sup>1</sup> Here a wheel has 12 areas of indentations through which a detent may fall. It does not turn continuously as would a wheel in the time train, but only when the strike train is activated. Each indentation is spaced slightly further away from its neighbor than the last. In this way the detent will remain on the rim of the wheel (thus allowing the bell to be struck) for a longer period of time until the longest stretch is reached at 12 blows. The shortest period is one. When the detent reaches an indentation, it falls into it thus locking the strike train and stopping the bell from being struck. The wheel is designed to turn twice each day. There were many variations of the wheel itself, in some rare cases it was designed to turn once per day and so had twenty four spaces of increasing length. A similar set up is used to strike the quarters with the wheel having four indentations of increasing length around the count wheel.

This device is a good example of what, for a better term, I'd call a 'perfect invention'. Its design, form and function has remained virtually unchanged from inception through the end of the mechanical tower clock - some 600 years.

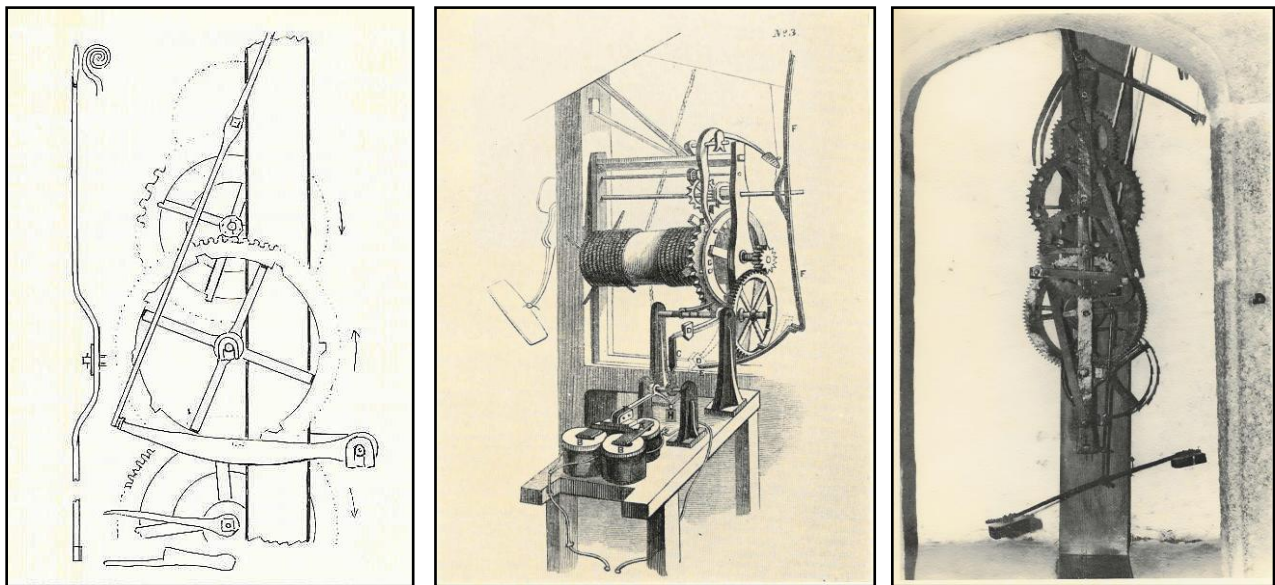

The earliest striking control worked by where one flat bar was mounted on an arbor corresponding to the fly arbor. One end of this bar locked on a detent controlled by the count wheel. An arm on the great wheel of the going train lifted the detent clear once an hour but still held the bar for a few minutes thus providing the warning feature. This is known as 'flail locking' and was introduced around the same time as the count wheel.<sup>3</sup> A flail locking clock is a fairly crude piece of engineering, with its long, (up to 6 feet), flail whirling around to crash against the locking piece at the end of each striking sequence. It demands a layout which is awkward. There must be clearance at the front and back for the flail and the fly so the movement must be free standing, and there must also be room for someone to wind it at one side or the other - which he must do with the barrel set inconveniently high and the other awkwardly low. Not to mention the danger of being seriously hurt by the flail if he chooses the wrong moment to pass through its arc!



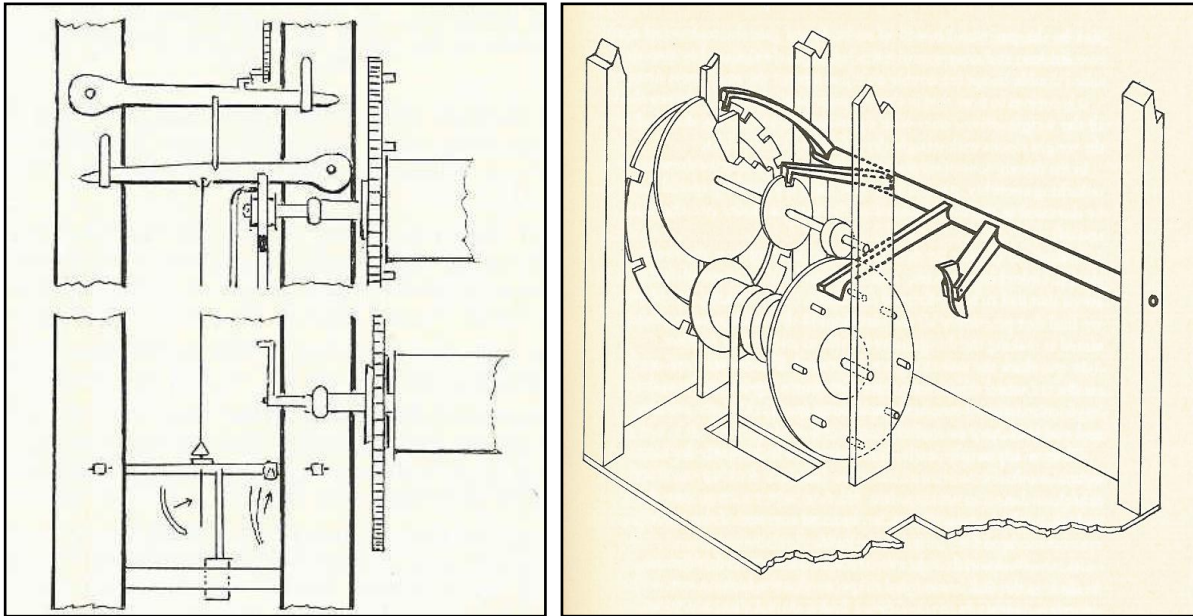

The next method of control developed had the hour wheel lift a weight suspended from a bar and release it suddenly. The over swing of the weight jerked the detent from the peg on which it locked and allowed the train to run. This is known as a 'kick starting or flirt' system. This was a great improvement from the flail system. It needs only clearance for the fly at one end and for access to the capstan-bars for winding the clock in the front. Locking is far less brutal because smaller moving parts have less mass.<sup>4</sup> Later the system was simplified and the weight and peg were replaced by a notched cam - '*cam locking*'. The pivoted actuating device known as a 'nag's head' was replaced with the cam detent system by the mid 15th century and later the detent became a roller wheel. This basic concept remained unchanged through the end of the era of mechanical tower clocks. It's simple and reliable.

**Rack and Snail and contemporaneous strike control, (right and next page).**

Invented in 1676 by Edward Booth/Barlow (1636-1719).<sup>5</sup> The original motivation for this invention was the fact that it was impossible to know the time in the middle of the night without having to light a candle or other combustible material.

Barlow's invention allowed one to trigger the strike train at will and get the prior hour to chime, thus giving the time to the nearest hour when no light was available. This is impossible to do on a clock equipped with a count wheel since that system is not self-correcting.

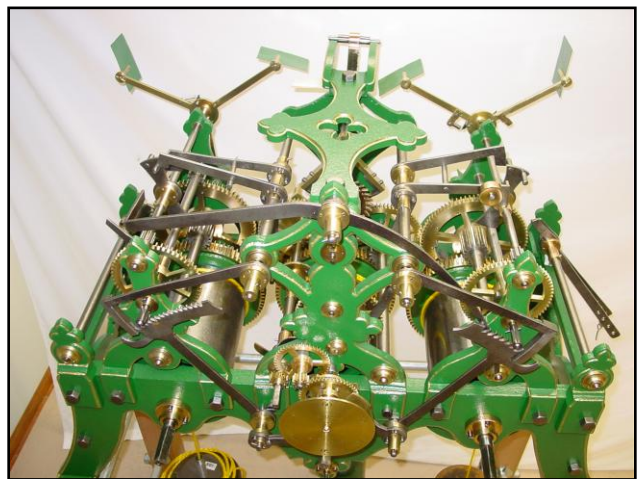

Another advantage of the design is that it is self-correcting. Should the strike train stop before the time train, it will automatically correct to the right strike sequence upon start up of the strike train. In a count wheel design the wheel must be readjusted, and, in fact, the wheels were designed to be easily removed so as to be turned to the right position for just such events. Regrettably, as often happens with innovative ideas, Barlow was unable to materially benefit from his design since he was slow to apply for patent protection. In 1687 King James II of England declared Barlow's repeat mechanism cannot be patented since it had been, in modern parlance, 'too long in the public domain'.<sup>6</sup> Imagine the wealth Barlow and his descendants could have had if the King ruled otherwise! He needed a patent attorney, although the King would probably have dispatched the hapless attorney 'to the tower'! Most clock subsystems have had many variations. The rack and snail strike system is one of the more complex and therefore, has had many permutations.

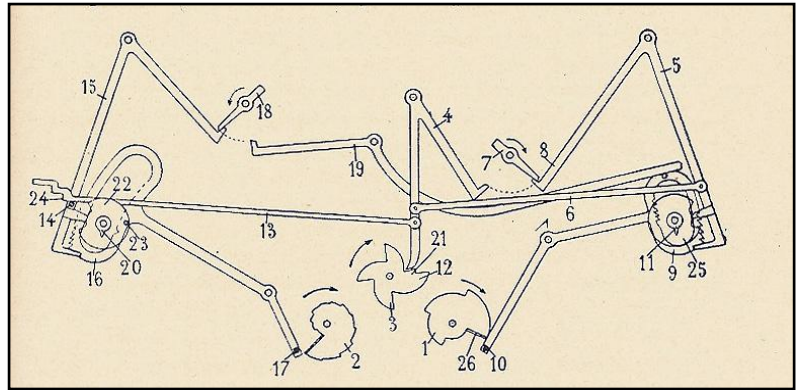

The basic strike control for the rack and snail device was adapted from the count wheel cam locking system. The same 'warning' device is used for the racks to be dropped into position before the strike sequence begins (a.k.a. setting up). Thus the hour rack and if there, the quarter rack is in position according to the step on the snail. The warning also allows for a more accurately timed sequence so that the bell will be struck closely to the appointed hour or quarter.

### Pin, Roller Pin.

The pin system used for lifting hammers precedes the invention of clock work, perhaps by many centuries. So it is no surprise that this would be the first. The use of rollers comes along quite early and examples are seen in clocks from the 14th century.

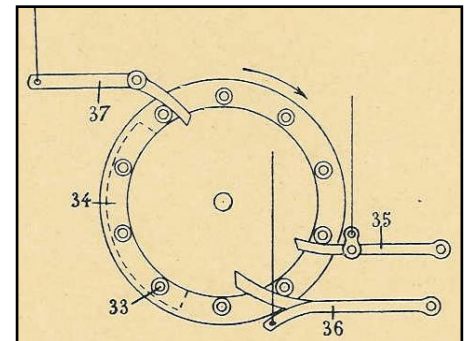
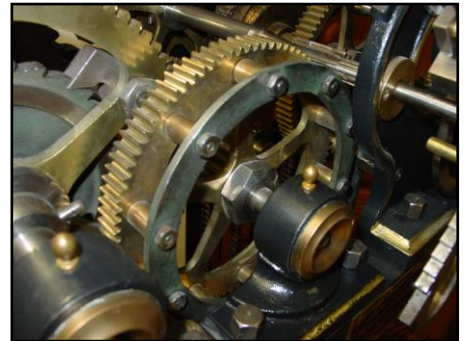



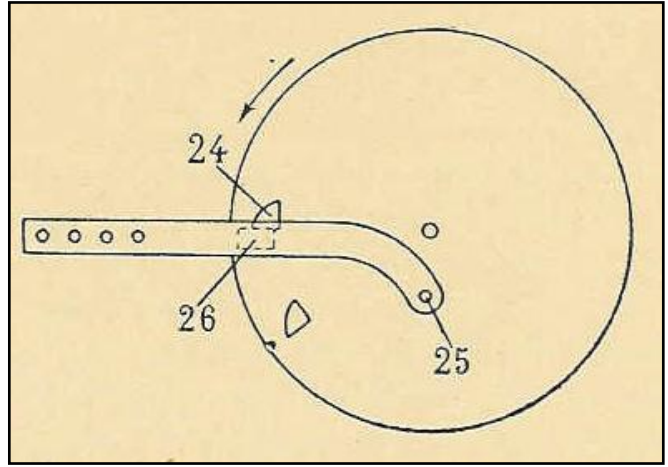
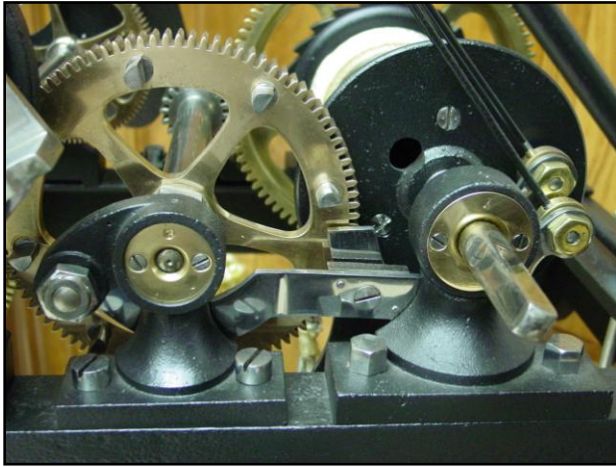

### Cam and Modular cam systems.

Cams allowed for greater precision in timing of the bell hammer actuators. They could generally be placed more closely together and were more robust in construction, useful when large hammers were needed. The modular - one piece - design is credited to E. B. Dennison (Lord Grimthorpe) and was first used on the clock at Westminster known as Big Ben. Its advantage is economy and strength. Most often the cast iron cam ring is fastened to a brass wheel but can also be cast with the wheel as one piece in the case of a movement having cast iron wheels. It may surprise many in the domestic clock world, but a fair number of tower clocks in the 1800's were manufactured with cast iron wheels, and yes, operating on steel pinions! A great many tower clocks from Germany and Central Europe used them. Even the illustrious Edward Dent made tower clocks with cast iron wheels including one of the most famous and accurate, the tower clock at Westminster - Big Ben! In fact, cast iron has a fairly low coefficient of friction as it contains graphite and display greater adverse effects upon pinions versus brass.

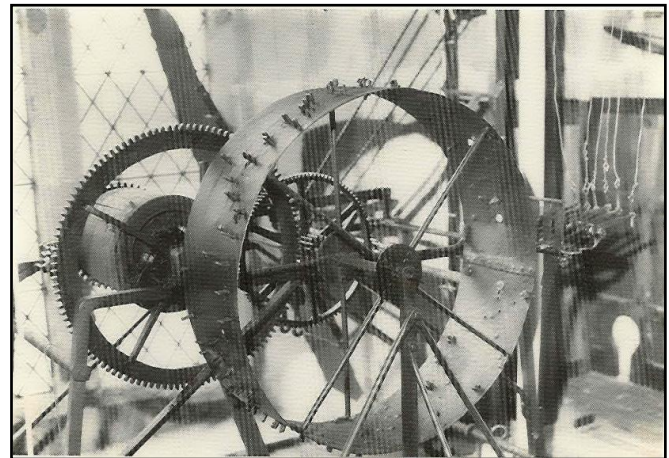
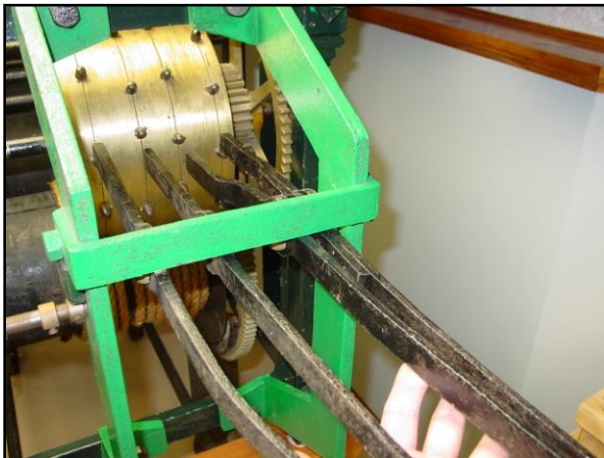



**Carillon, (bottom prior page and below).**

The carillon is basically a drum fitted with projections to actuate hammers that strike on bells; similar in concept to an oversized, (very oversized!) music box (prior page and below). The oldest extant clock equipped with chimes is at Aalst in the Low Countries, Belgium, 1481 <sup>1</sup>. However tower clocks were known to be equipped with carillons for over a century earlier to this.<sup>7</sup> The first two pictures show the oldest clock equipped with a fully programmable carillon. It plays twelve bells and is from the St. Jacob tower, The Hague, Netherlands, dated 1542. Note carefully the clever way the pins are designed. Not only can any tune sequence be played via the arrangements of the actuating pins on the drum but the pins themselves are variably shaped so as to subtly affect the timing of hammer strikes. This allows the programmer to not only create tunes but customize the tune to a particular taste!<sup>8</sup> It is not a stretch to consider this a forerunner to the programmable loom of Jacquards' design in 1840; some 300 years later which was an antecedent to the modern programmable computer!

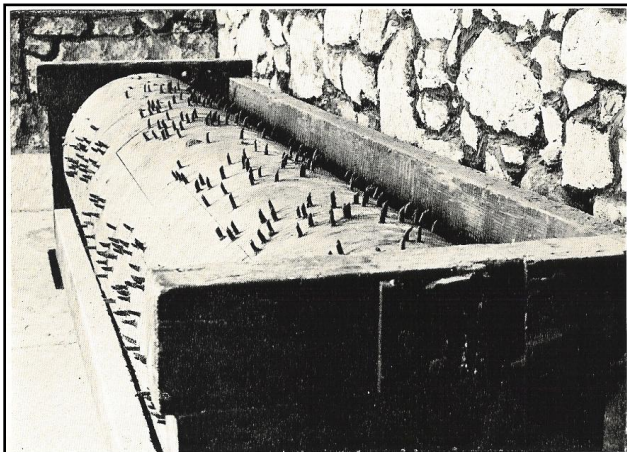
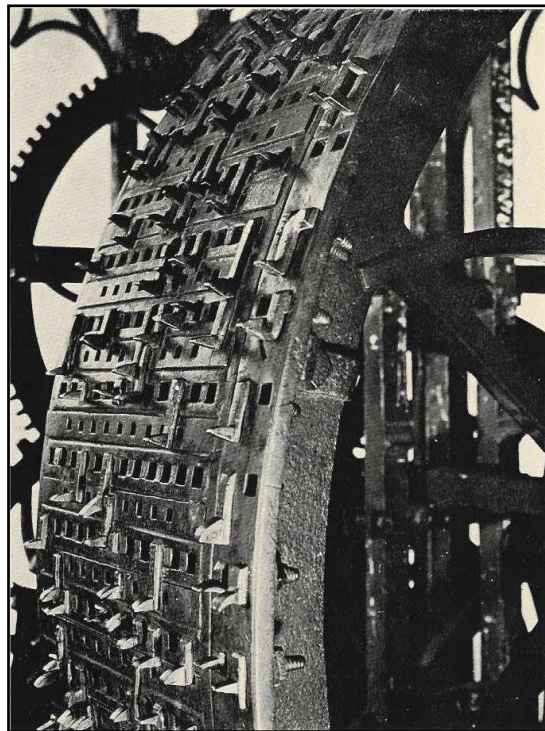
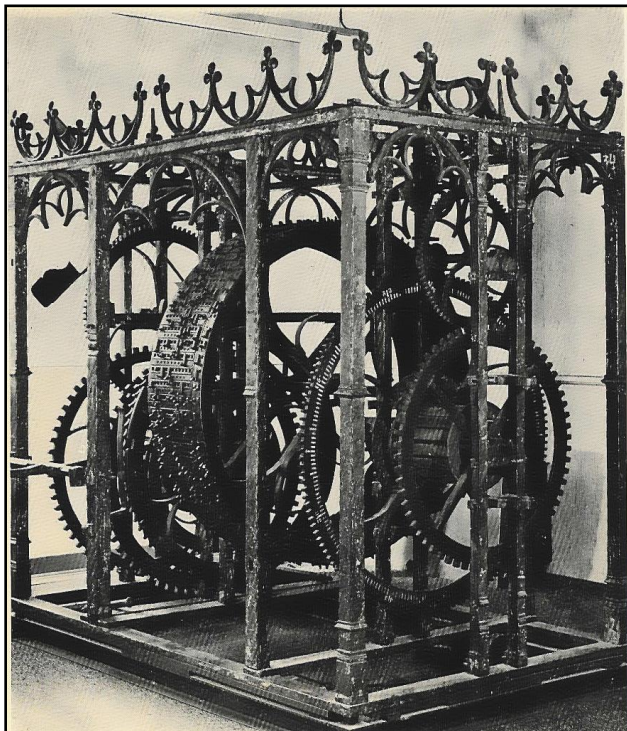

This example (left) played over thirty bells.

Video of a carillon playing *Twinkle Twinkle Little Star*:

<http://www.my-time-machines.net/carillon.wmv>



## TYPICAL WINDING SYSTEMS USED IN TOWER CLOCKS

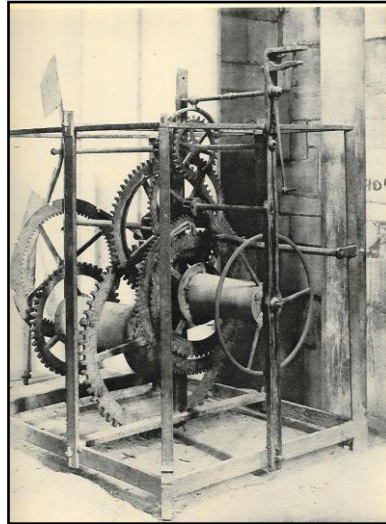
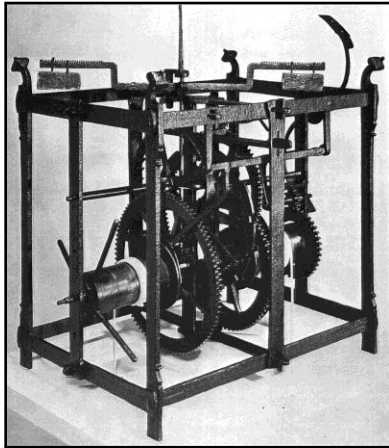

**Capstan** - Known since antiquity and the earliest form of winding applied to tower clock work. Later the capstan was replaced by a smooth wheel rim like that of an automobile steering wheel.

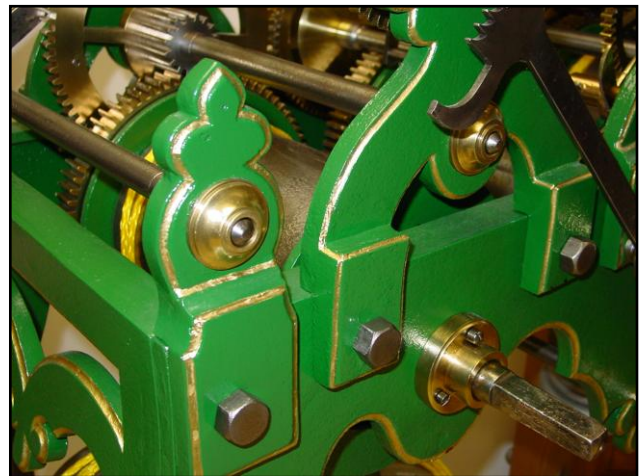
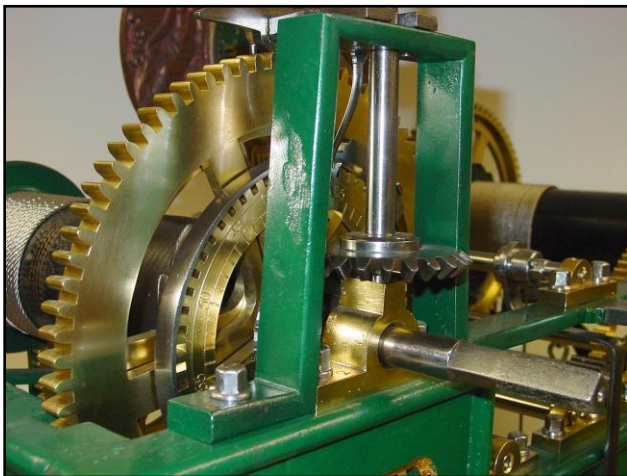

**Direct: winding-square** – Unknown, from antiquity

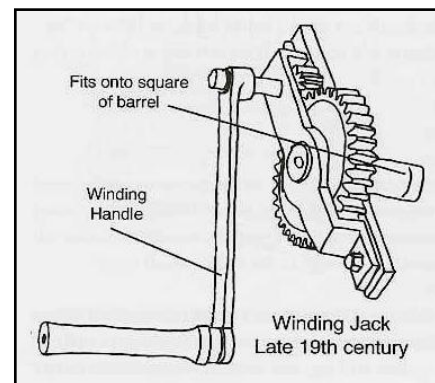
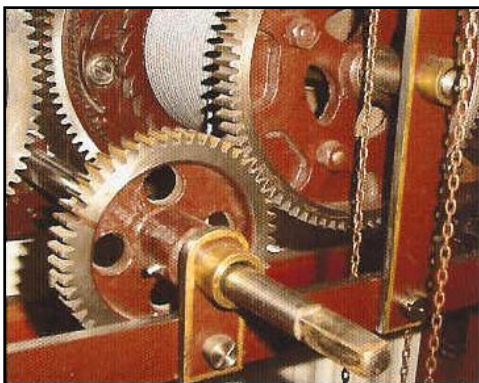

**Reduction gear / Winding Jack** – Unknown, from antiquity.



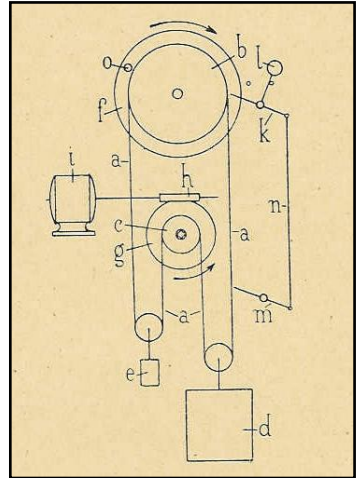
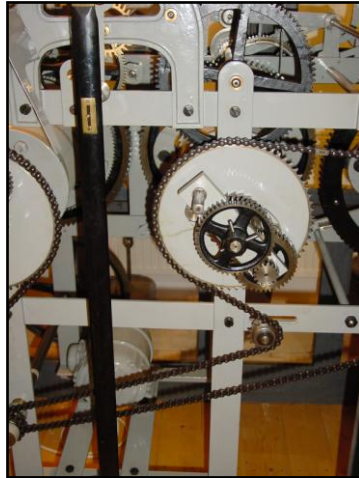

**Electric** - At first sporadically applied to tower clocks in the late 19th century. Mostly in cases where the movement was installed in an area that made regular winding by a person difficult. Began to appear as an O.E.M. feature in the 1920's.

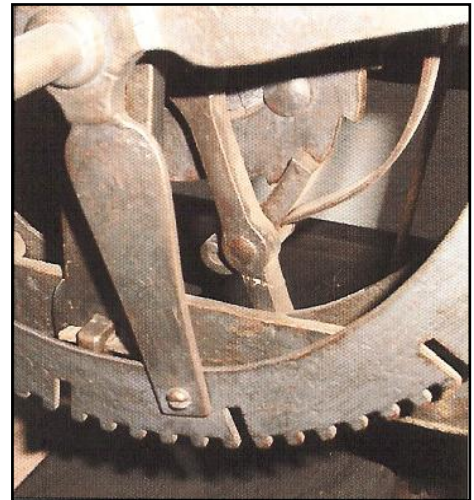
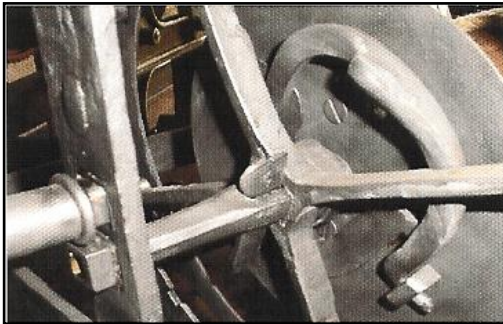

**Stirrup** - (above). Earliest click system applied to clockwork. **Ratchet and Pawl** - (right), relics from 100 BC, China, but begins to appear in European clocks late 16<sup>th</sup> century.<sup>3</sup>

**Maintaining power systems: Endless Loop** - Invented by Christiaan Huygens, Holland, in 1658.

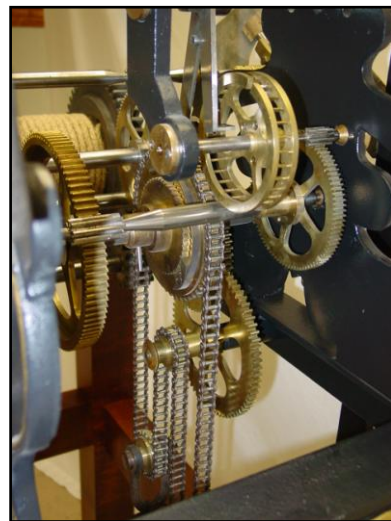
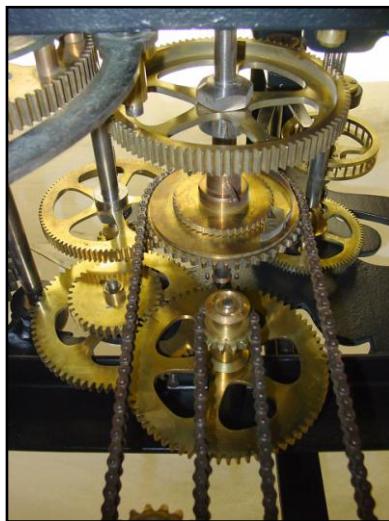
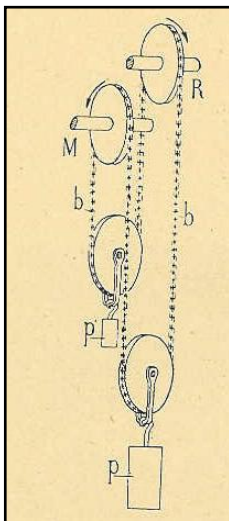



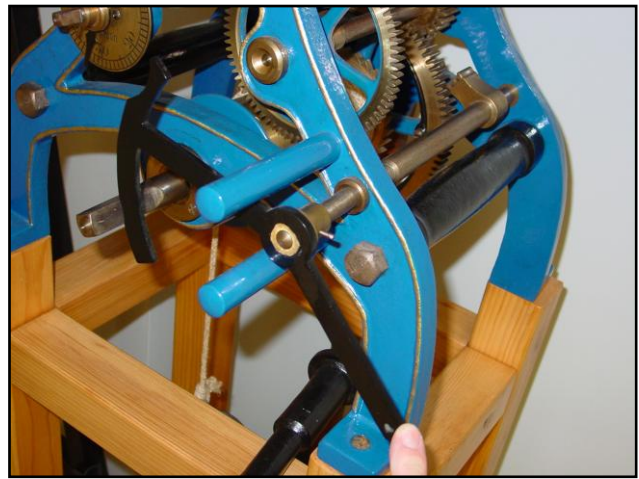
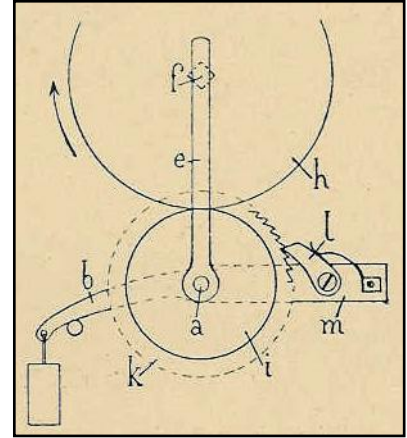
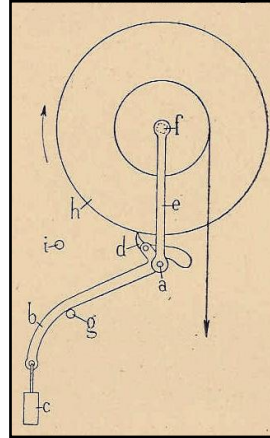
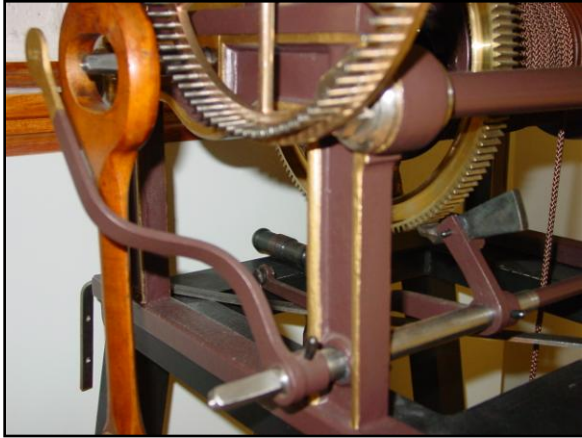

**Bolt-and-Shutter - weight driven** (above). Inventor unknown. This system got its name from the fact that in order to wind the movement one has to move a weighted lever (the bolt) to engage the movement. Attached to the bolt is an arm (the shutter), that in the clock's normal operating mode, blocks access to the winding square. Therefore, to engage the maintaining power system one has to move the bolt, for the winding crank to be inserted; guaranteeing the maintaining power is engaged during winding. Usually the bolt is automatically disengaged after a minute or two.



**Bolt-and-Shutter - spring driven** (above, right). In this instance the weight is replaced by a coil or leaf spring. Leaf spring version invented by Ahasuerus Fromanteel, England in the mid 1600's. He first applied it to his long case clocks.<sup>1</sup>

**Harrison's spring / coil system** - Invented by John Harrison, England, and first applied in his famous marine time keeper H1; completed in 1735 and was the first in a series of timekeepers created in his quest to win the prize for an accurate enough timekeeper to be used in locating longitude at sea. His original version used the coil springs shown in the middle diagram. This was rapidly supplanted by the cheaper and simpler coil design.<sup>2</sup>

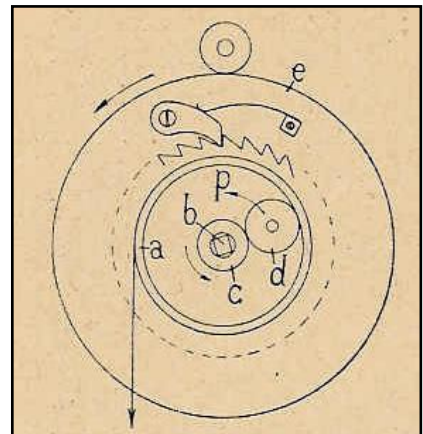
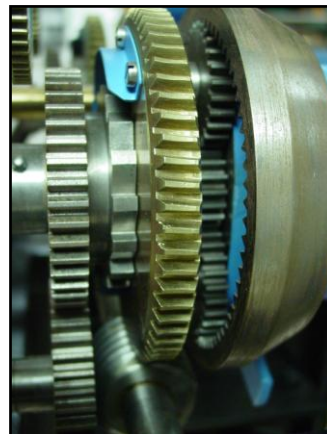
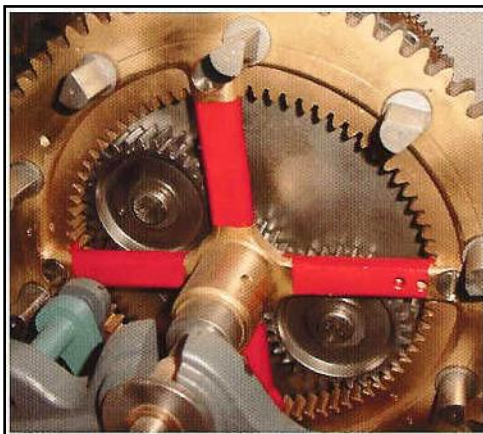
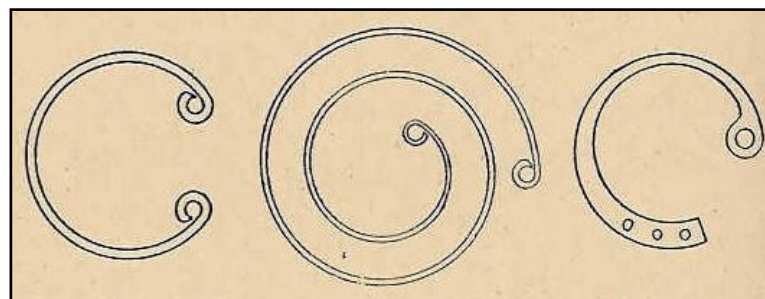

**Epicyclic (sun-and-planet).** This gear system is known from antiquity but applied to clock maintaining power systems in the later 19th century. It also acts as a reduction gear as well. Especially useful in clocks that employ electrical winding



## TYPICAL TOWER CLOCK INSTALLATIONS

Unlike the clocks set up in a typical domestic collection, tower clocks nearly always had their weight lines to the barrels strung from above. The illustration below is probably a stylized rendering as there is no provision for a stairway! However, it is not far from truth. In the towers I have visited, I have

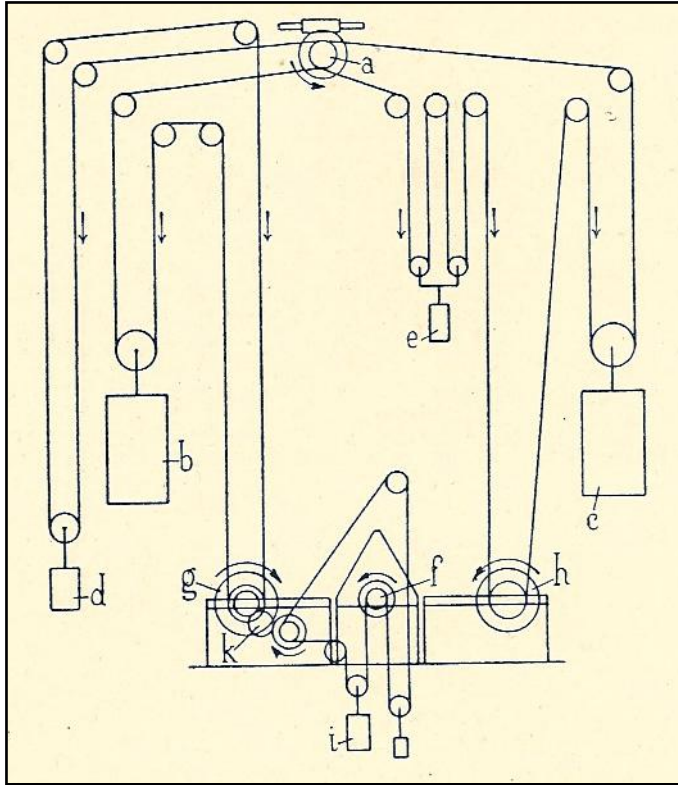

rarely seen a design that had even a modicum of provision for the comfort or safety of maintenance personnel. This may be partly responsible for the general demise of these clocks. Note that the bell has a clapper, as well as a wheel to allow for manual ringing.

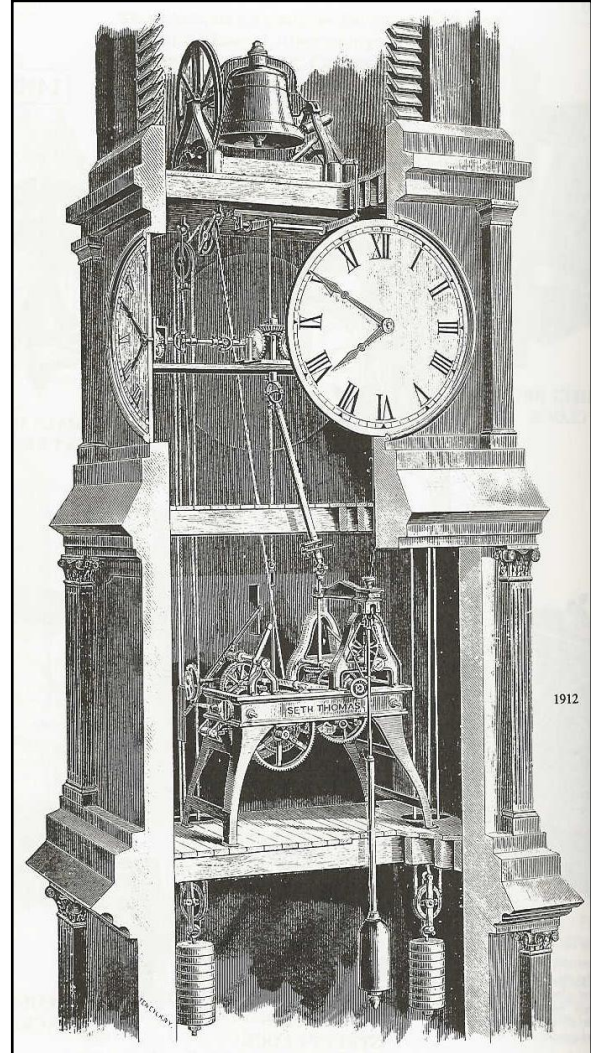

Check the complex rigging in the diagram above.

This occurs when a clock is electrically wound from one motor yet has three trains where each runs at a different rate. For example, the line on the time train unwinds at a slow, steady rate. The hour train line will unwind with greater speed as the hours struck increase from one to twelve; as will the quarter chime train from the first through the fourth quarter. The additional weights, pulleys and lines allow for these differences within a limited amount of drop. These, however, add to complexity and maintenance issues. Sometimes, three motors are used to avoid the problem as well as further limit the drop necessary.

The illustration on the next page shows the various positions that can be found of the clock in relation to the bell; the most common arrangement being the first and third. I have never encountered the second, where the clock is above the bell.

*Four Methods of Installation*

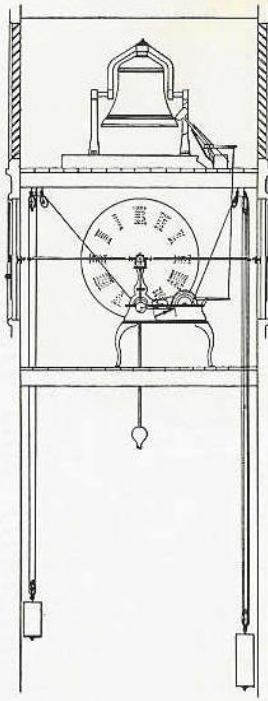

*Diagram  
Plate No. One*

Showing clock in position with dials opposite the clock, and the bell above clock and dials.

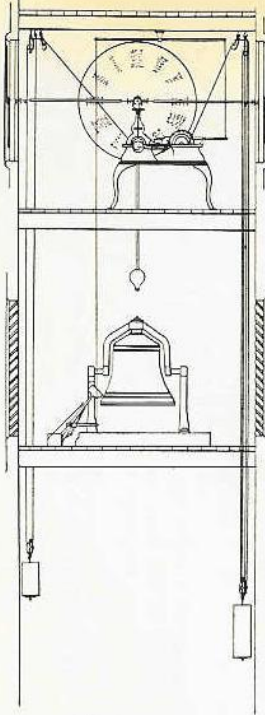

*Diagram  
Plate No. Two*

Showing clock in position with the dials opposite the clock, and the bell below clock and dials.

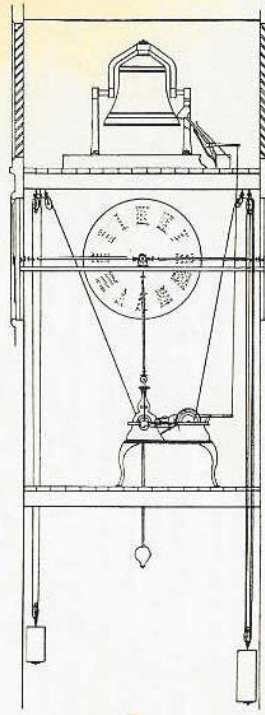

*Diagram  
Plate No. Three*

Showing clock in position with the dials above the clock, and the bell above the clock and dials.

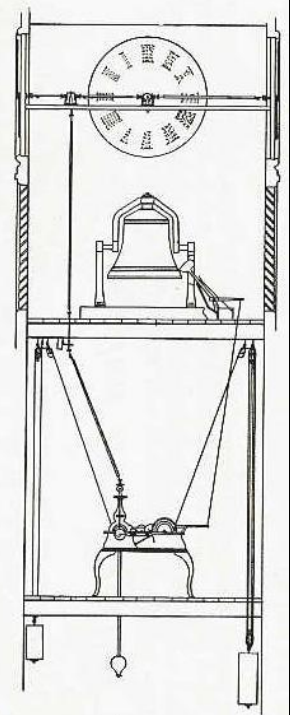
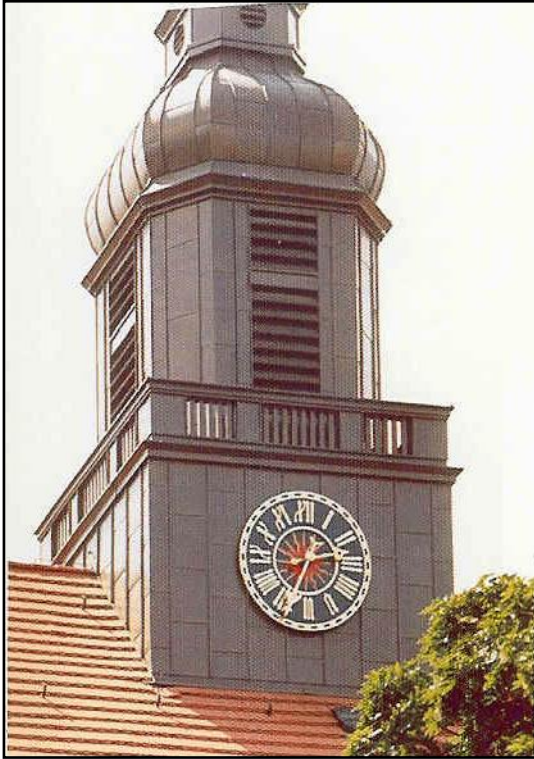

*Diagram  
Plate No. Four*

Showing clock in position with the dials above the clock, and the bell between clock and dials.



**EXTERIOR VIEWS OF SOME UNUSUAL CLOCK TOWERS**



**Kopenplatz, Berlin, Germany**



**Marburger Rathaus, Germany, 1527**



**Esslingen 1561, Germany, 1588**



**Heilbronn, Germany, 158**



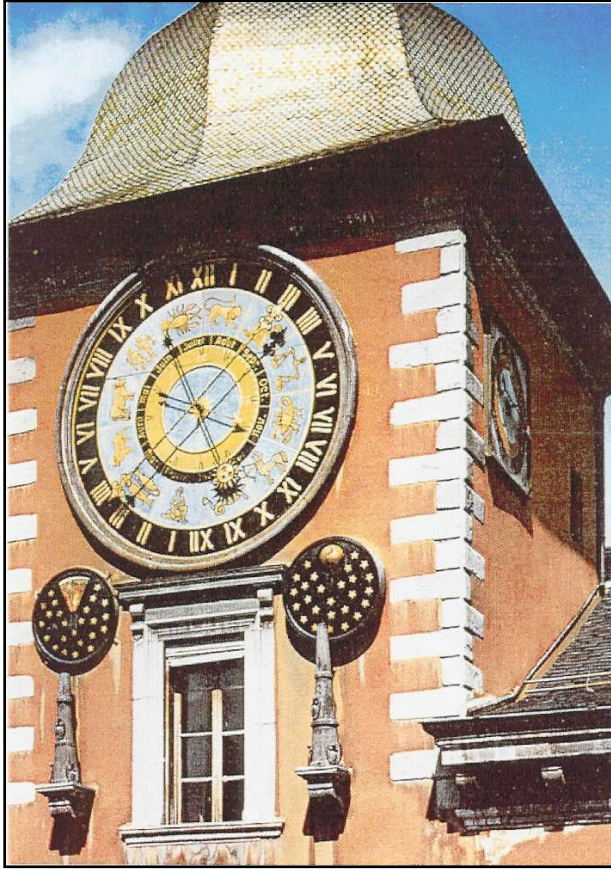

**Sion, Switzerland, 1668**

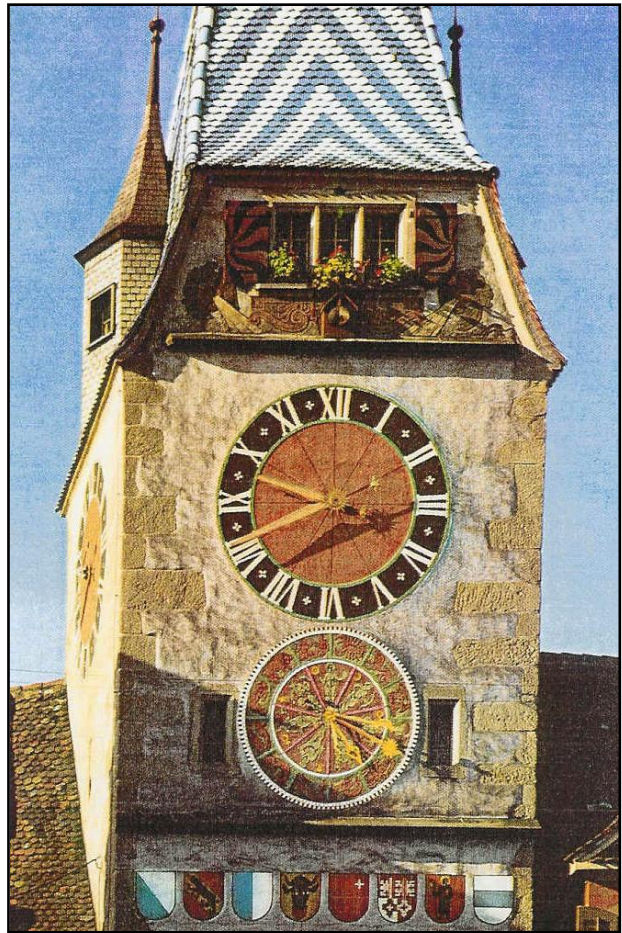

**Zug, Switzerland, 1574**



**Palace of Westminster, London, England, 1854**



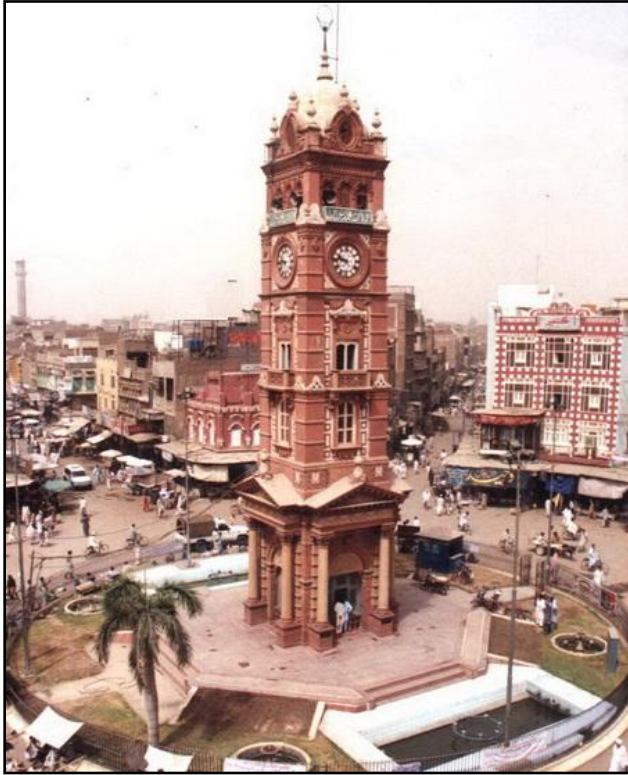

**Faisalabad tower, Pakistan, 1903**

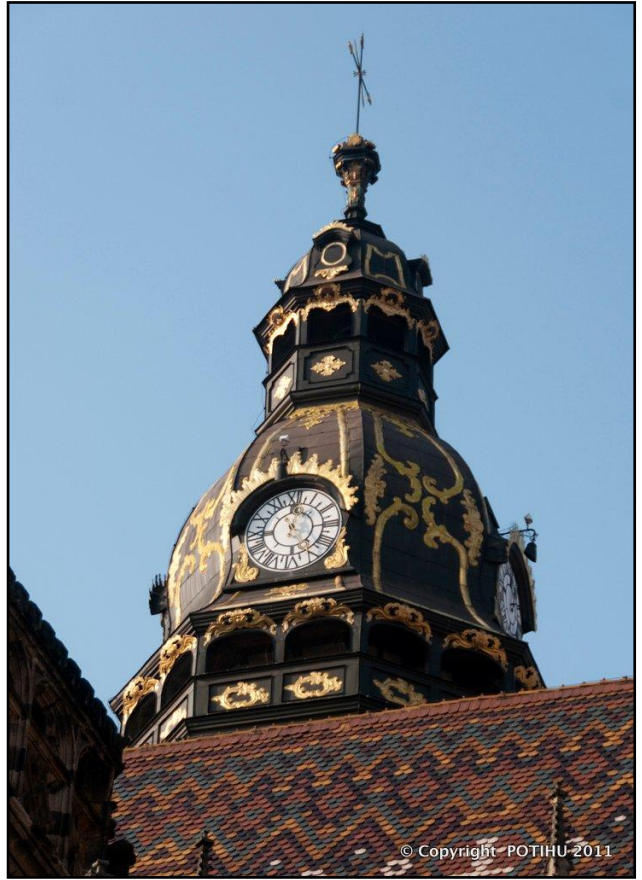

**St. Elizabeth Cathedral, Kosic, Slovakia 1508**

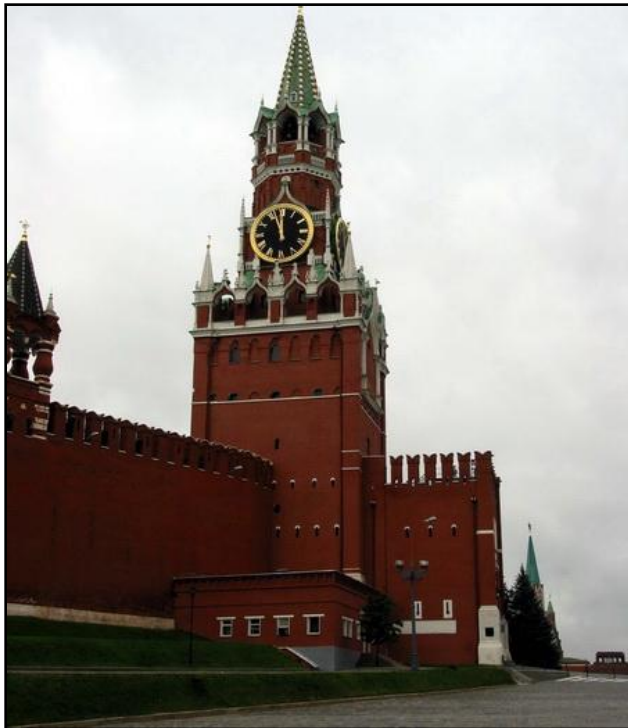

**Spasskaya tower, Kremlin, Russia**



**Zytglogge, Switzerland**

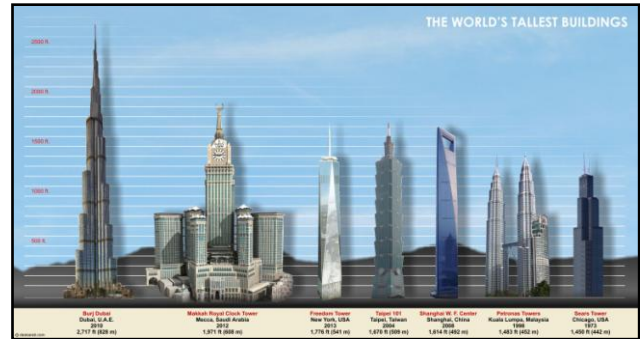

### Mecca Royal Hotel Clock, 2012

At this time the second tallest building in the world at 1971 feet. It has the largest diameter dial at 39 meters or 127 feet, (there are two smaller dials on either side). Big Ben's dials top out at 7 meters or 23 feet. The clock dial and associated cupola is illuminated by 2 million LED lights allowing for an ever changing pattern format. The dials are comprised of 98 million glass mosaic pieces and are outfitted with a 17m long hour hand and 22m long minute hand. These are, however, electrically rather than mechanically driven. Another 21,000 white and green lights run along the top of the clock and flash during the day's five calls to prayer. These prayer lights are visible up to 30km away. Notice the cutaway section. The clock interior contains four levels of horological and astronomical related exhibits. The estimated cost for the entire hotel and tower complex is over 15 billion dollars.





**Zimmer Tower Lier, Belgium, 1425**

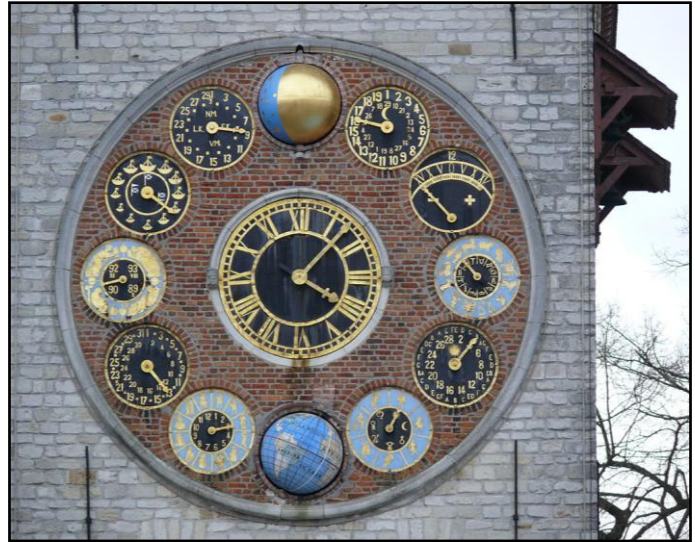

**Dial close up**

Zimmer tower at Lier, Belgium. The tower was built in 1425. The current dial was added in 1928, by the town's local clockmaker, Louis Zimmer and deserves a bit closer of an examination.

The center dial shows the time in hours and minutes. Around the center, clockwise from top: phase of the moon, metonic cycle and the epact, equation of time, zodiac solar cycle and the dominical letter the week, the Earth's globe, the months, the Calendar dates, the seasons, the tides, the age of the moon. This person loved excess and is a man after my own heart!

## TOWER CLOCK RESTORATION HIGHLIGHTS

The following outlines the procedures used in a typical restoration. I will be using, as an example, a small, manually wound two train clock with a Robin style remontoire. Made in the 1890's by Phillip Horz from Ulm, Germany. Repairs and replacement of broken parts is so varied that for our purpose here we will assume a complete and intact movement as was this movement. Total restoration time 116 hours. Parts count - 247.

With the advent of digital photography, there is no excuse for not fully documenting each phase of restoration. This is especially important in the initial survey and disassembly. A large tower clock restoration, if accomplished during one's 'spare time' may take up to a year or longer. So when it comes time for reassembly, one may not always remember how everything went back together! Only rely on reference points for parts orientation that are provided by the original maker through indelible marking (like punch marks or punched / engraved numbered markings). Paint, shadows left by separated parts, or placing parts in positions oriented in a particular way to each other will not suffice. As you restore the movement these telltale signs will disappear. Parts oriented and organized on a table will become jumbled and confused over the longer periods of time that a large restoration can take. If you tend to use orientation of parts to each other as a reference, then at least take pictures of this as soon as the parts are removed.

Often, careful notation of makers marks will reveal that a prior restorer did not always put everything back the way it should have been! Unless the movement is in running condition before restoration, resist the urge to correct what may appear to be bent or misshaped parts. Often these are this way for a reason that is not immediately obvious!



On many of my restorations I tend to leave all the metal unpainted except the frame. Even the bolts that secure the frame are unpainted. All surface areas excepting pivots, holes and bearing surfaces are protected by paint; or if to be exposed metal, lacquered. This includes wheels and arbors as well as all bolt and screw heads (not the threads). I have seen many prior restorations where the frame still looks great but some light oxidation has already begun in patches on the arbors and the brass work is dull. There is simply too much work involved to spare these areas.

**Initial survey:** Take inventory of condition. Note necessary repairs, restoration, replacements. Take plenty of pictures of movement as found. Start with front, rear and side elevations, 3/4 views and top.



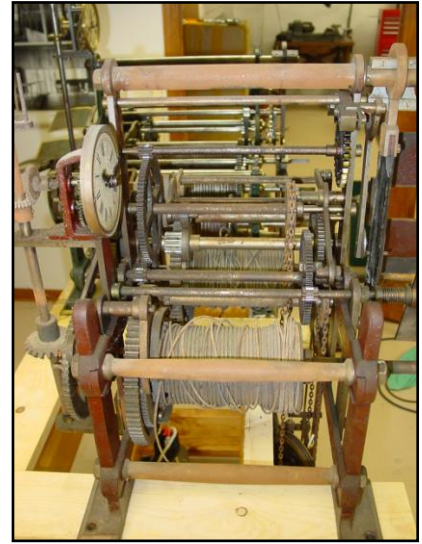
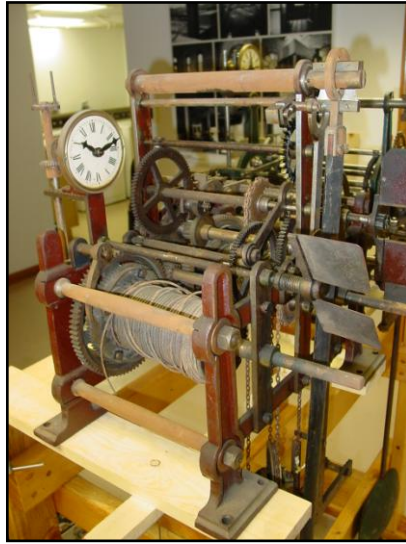

**Disassembly:** During each phase of disassembly take plenty of pictures. Make drawings and notes of any peculiar ways that parts may fit together or orientations that are not obvious. All screws should be noted to their mating holes and placed back unless evidence shows that they were misplaced at a prior time. Although screws may look the same, often they are not - especially on movements made prior to the 1880's.

Sometimes disassembly can present challenges. These especially true where a lot of rust has occurred or in areas where the manufacturer thought later disassembly would never occur. An example of this is the main wheel barrels. These are often very difficult to break down. To remove recalcitrant screws it is advisable to use loosening oil. I use a plumber's product called 'Pipe Break'. It comes in a spray and works better than WD40 in loosening up parts. Let it work for at least several hours or better overnight. During this time tap the screw or part lightly with a hammer to let the oil work its way in. In cases where this will not work, I have rigged up a compression jig made from a pipe clamp and a screwdriver that has a square shank. The part is placed into the jig and the screwdriver is compressed so it seats very firmly into the screw head slot. The screwdriver is then turned by the shank with a wrench; avoiding damage to the slot.



**Degreasing:** This step is extremely important to do 100%. Any traces of oil, grease or dirt will interfere with any later restoration steps. Contaminants will foul wire wheels, polishing compounds, files, etc. No acceptable results can be had without a clean, dry surface. Wipe off excess grease from pivots and holes and all other areas with a cloth. If available use an ultrasonic cleaner. These save plenty of time and do a better job, especially on complex parts than can be done by hand. I have three ultra sonic cleaners from 1 pint to 5 gallons for different sized parts. Areas such as wheel spoke / hoop inner corners will have to have additional removal of dirt by hand. Soaking and de-greasing may have to be repeated. The same procedure holds for removal of paint.

**Parts restoration:** This will vary according to 'as found' condition; original level of finish as well as final desired level of finish. This clock was in fair to poor condition as far as oxidation. Very good condition as far as the completeness of the movement and the critical wear areas such as pivots, pinions and wheel teeth.

**A. Brightwork (brass) - wheels.** This clock differs from many in that the wheels, with the exception of the escape wheel, were made of cast iron. The wheels are also painted with the exception of the toothed hoop. In this case (as with the frame) I use a lacquer that is compatible with the paint I use. After the metal on the wheel is cleaned and finished, I lacquered the rim. Then the rim is masked and the inner rim, spokes and hub are painted.



If they were brass, after a thorough cleaning, a medium and then fine brass wire wheel will bring the part up to a fine satin or to a polished luster depending upon the original finish. Pay special attention to wheel teeth, these should all be perfectly cleaned. Teeth are much more noticeable on the larger wheels found on tower clocks. I use a narrow wire wheel on low speed to clean each tooth individually. Then follow up with a fine

brass wheel. If the wheels were polished, then use of a polishing wheel with rouge compound, followed by a buffing wheel and then soaking in a solvent to clean off the compound. In this case, where the wheels are cast iron, a simple procedure with a medium and fine steel wire wheel does the job. In the case of brass wheels additional hand work is needed in areas such as inner hoop, spoke and corner areas. This can be accomplished with the aid of cleaners like Brasso. If such cleaners are used (as with L&R type cleaners) the same careful rinsing procedures must be done. Finally the entire



wheel is lacquered. I use a spray for this. Lacquer is preferred over enamel or other clear coats because it is far more forgiving. Lacquer tends to 'tighten up' as it dries so minor drips and sags will disappear. This tightening up also reduces the danger of developing an 'orange peel' surface. It also dries very quickly so work can continue at a faster pace.

I've been asked if lacquering the entire wheel is detrimental due to the fact that the teeth are done. This is not a problem. After a few hours of operation a fine white dust appears on the teeth and pinion. One needs to just brush this off. After a few days of doing this, the dust accumulation stops. You now have a fully protected assembly that will look good for years.

**B. Pivots.** These are handled in the usual way. Tower clocks usually do not have as fine a finish as would smaller clocks, but pivots as well as pivot holes still need to be smooth to the eye and pivots burnished.

**C. Arbors/pillars.** Often these are badly oxidized. No restoration will look good with pitted arbors. If the oxidation is very light, then it can be removed with a steel wire wheel on medium speed. If desired, it can then followed up with a medium and fine grades of steel wool. However, usually the rust is deeper, and I desire a smooth, fine finish. I begin with a wire wheel to remove all traces of rust from the surface and pits. The arbor is then mounted on a lathe. First a fine file is used if the rust is very deep. After the pits are removed various grades of wet/dry paper are employed; beginning with 320 then 400 and 600. This brings the part to nice fine satin finish. If a higher polish is desired, then follow with 800 1000 and 1500. Followed with a quick pass on the buffer will give a shiny surface.

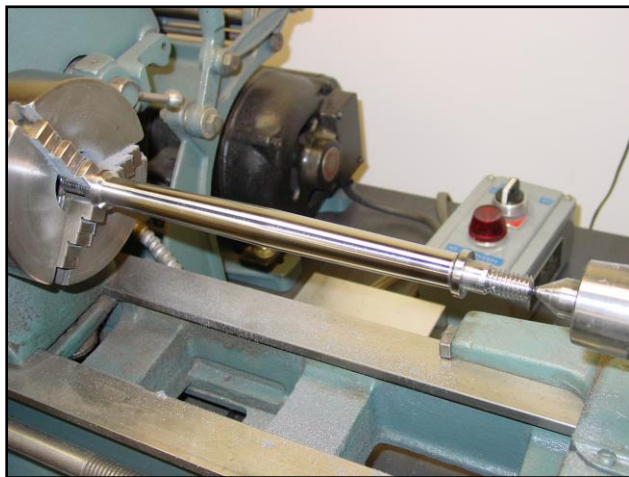

**D. Levers, parts.** These depend on whether they are to be painted or left as bare metal.

**E. Frame.** First all metal parts are assumed to be bare, clean metal. This clock frame presented special challenges. The design called for a painted surface, pin striping as well as a bare metal edge, and because I wanted this edge to also be lacquered, several steps had to be followed. The first thing that needed to be done was to see if the paint could be compatible with the lacquer. Once such a combination was found work could proceed. First was the frame strap edges (pivot bars). This involved several grades of sandpaper and wire wheel work. The pivot bushings were

an unusual design where they protruded far beyond the surface of the frame. All of these bushings had to be polished. Then the part was lacquered. Afterward the strap edge and bushings were covered with masking tape and the tape carefully trimmed. Then the surface was painted and the edges were pinstriped. After this the tape was removed and one hoped that the edge was properly masked. Otherwise the part had to be completely stripped and redone.

**F. Miscellaneous.** Wood pendulum stick was lightly sanded and repainted with a gloss paint.



**G. Reassembly.** If all the prior steps were followed and the clock is fully documented, reassembly should be straight forward. I try to use cloth gloves during this procedure, even though all the parts are coated. This is especially true when working on skeleton clocks or any movement that has not been lacquered. Put a drop of light oil on all screw threads before insertion. Avoid the urge to over tighten.



Another thing I do, just for fun, is to put a 'time capsule' into one of the barrels before it is reassembled. Unlike a movement in a cased clock, everything in this project is open to observation. So it is not practical to note name and restoration dates as is commonly done on a conventional movement. Using the time barrel allows me to put a baggie filled with information and some pictures of the restoration and myself. Since barrels are rarely opened who knows when someone will see a picture of the person who did the work?

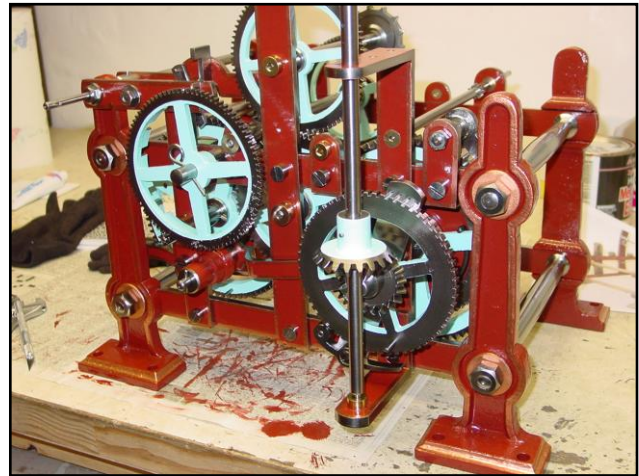
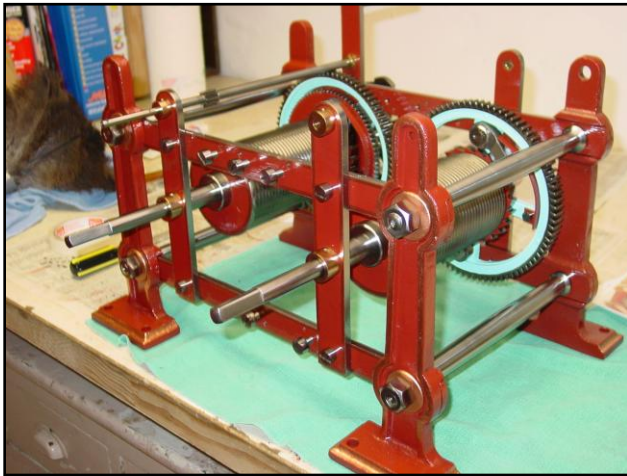
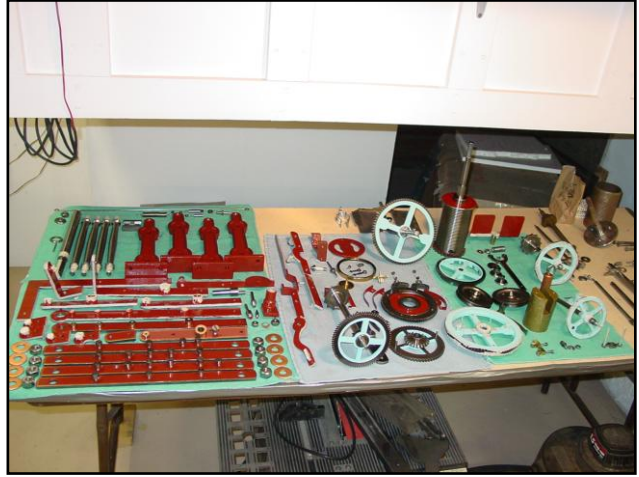

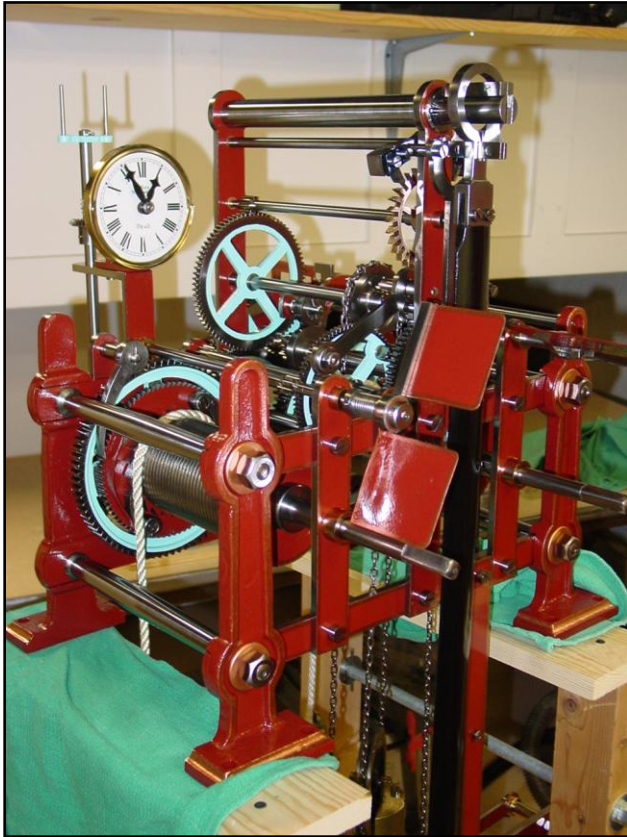

## Footnotes

### Introduction

1. Antiquarian Horology, vol. 23, no. 3, March 2003. "Epicyclic Gearing and the Antikythera Mechanism - Part1", M.T. Wright.
2. Antiquarian Horology, vol. 11, no. 2, Winter 1978. "Turret Clocks - A Review Of Their Evolution", D. F. Nettell.
3. There are many legends surrounding this Clock, the most famous of which is about the master clockmaker Hanus himself. It is said that the Old Town Councilors had his eyes burnt out with a hot poker, so that he would not be able to build another such instrument elsewhere, which could overshadow the beauty and the fame of the Prague Clock. Master Hanus then allegedly asked his apprentice to take him to the clock, which he deliberately damaged so seriously, that nobody could repair it. Those who tried either died in doing so, or have gone mad. In reality, the Clock was not very reliable and often did not work, in spite of extensive repairs. A further legend gives the Skeleton magical power of foretelling the future and says that if the clock is left damaged for a long time, hard times will result for the Czech nation. From internet site: <http://www.orloj.com/>
4. Antiquarian Horology, vol. 10, no. 1, Winter 1976. "Rye Church Clock", E. J. Tyler.
5. The Triumphs of Big Ben, John Darwin, 1986.
6. Some Outstanding clocks over 700 Years, H. Alan Lloyd, pg 38. First clock with a minute hand on the same axis as the hour hand was made by A. Britten, England, 1577. First second hand appeared on a clock about 1550.
7. Internet site: <http://www.booneshares.com/SomeAbrahamDarbycompanies.htm>.

### Escapements

1. Also an interesting dissertation about the St. Alban's Abbey is found here: <http://explorers.whyte.com/row.htm> . An excerpt that concerns the clock is below:

My biggest regret about this essay is that I did not press home the idea that I had about why Richard of Wallingford designed an elaborate and fantastically accurate astronomical clock for St Alban's Abbey. I did allude to it at a couple of points but I did not quite have the courage of my convictions, and the essay therefore ends on a rather unsatisfactory note. My idea was this. The big political problem for the Abbey of St Alban's in the 13th and 14th centuries was the issue of compelling the townspeople to grind corn at the Abbey's mills. The townspeople had won a political battle with the Abbey in 1327; the old abbot promptly died later that year, and was succeeded by Richard of Wallingford with his established



reputation as a scholar and astrologer. It took Richard four years until, probably facilitated by the new balance of powers brought about by Edward III's palace coup in 1330, he was able to compel the townspeople not only to grind corn at the abbey's mills but to surrender their own hand mills to the Abbey. He cemented the grinding stones into the Abbey's parlor floor, where the monks daily trampled over them as they went about their normal business.

What does this have to do with the clock? A great deal. The heavy metal gear technology for the clock is almost identical to the technology for the Abbey's mills, which Richard invested so much financial and political capital in. But on top of this, the most magical thing about the St Alban's clock is that it predicted lunar eclipses, accurately. Richard's intention must surely have been to demonstrate to the townspeople that the Abbey was not merely a powerful institution but also one with intimate connections to the celestial realms. The clock, if it had ever been completed according to its designer's will, would have taken the relatively mundane technology of the Abbey's mills and connected it directly to the heavens.

2. Antiquarian Horology, vol. 11, no. 4, Summer 1979. "The St. Alban's Clock", E. Watson.

3. Antiquarian Horology, vol. 13, no. 3, March 1982. "The Evolution of European Domestic clocks", Dr. F. A. B. Ward.

4. Antiquarian Horology, vol. 28, no. 5, March 2005. "The Coster - Fromanteel Contract Re-Examined", Frits van Kersen, pg. 561-567; in the same issue, "Some More Notes On The Coster - Fromanteel Contract", J. H. Leopold. pg. 568-570.

Here it is argued that a review of the contract between Huygens and John Fromanteel created in 1658 indicates that Fromanteel had been making pendulum clocks, albeit of a slightly different design, already by this time; thus casting doubt upon Huygens as being the sole, original inventor to first apply the pendulum to clockwork.

5. Antiquarian Horology, vol. 10, no. 1, Winter 1976. "Rye Church Clock", E. J. Tyler.

6. Clock and Watch Escapements, W. J. Gazeley.

7. Edward John Dent and His Successors, Vaudrey Mercer, pg. 392.

8. Antiquarian Horology, vol. 11, no. 6, Winter 1979. "The Fly in the Grimthorp Gravity Escapement", by Henry Wallman, pg. 629-631. The essence of this article is that the fly acts as an 'energy sink'. Accuracy requires an escapement system that provides a constant impulse to the pendulum despite varying energy demands from the hands (a big factor in the case of tower clocks with ice buildup or wind) and to a lesser degree variations in the wheel train due to oil viscosity induced by temperature and environmental contaminants. When demands are high the fly slows down, however, as long as it moves through its allotted 60 degrees (in the case of the Dennison double three-legged type) within the time it takes the pendulum to make one swing the escapement is unaffected. When demands are low the fly moves quickly, partially dissipating the excess energy as an air brake (i.e. heating the air). But because the fly is attached to the escape arbor through a friction clutch any additional excess energy that would be dissipated by slamming into the pallet stops is instead lost through the sliding of the clutch (again, negligible heat). This last issue is what distinguishes the Dennison gravity escapement from all earlier attempts to solve the tripping problem. The fly device is a nonlinear system making it well suited to varying demands. The table below neatly shows how a large change in demand from the external forces acting upon the movement is made into an even stream through the escapement as it reaches the pendulum. The Dennison is indeed a remontoire and escapement in one device - one of a very few practical 'escapement remontoire'.

	<u>Hands under heavy ice load</u>	<u>Good Weather, no wind</u>
Large Wheels	100	100
Hands	200	45
Fly	10	160
Pallet stops	4	9
Unlocking	1	1
Pendulum	<u>5</u>	<u>5</u>
Total (from main weight)	320mJ	320mJ

Conjectured energy flow in 'Big Ben', in millijoules per (two second) beat.

### Frame styles

1. Antiquarian Horology, vol. 12, no. 1, Spring 1980. "A New Look At The Dating Of Early English Clocks", C. N. Ponsford and J. G. M. Scott. This example from the Cotehele House, Nr Saltash, Cornwall, England.

2. Antiquarian Horology, vol. 6, no. 1, December 1968. pg. 37. This example from a church in Nottinghamshire, England. Signed Rich (Richard) Roe 1683. The design suggests Roe was coping a much earlier clock.

3. Antiquarian Horology, vol. 12, no. 1, Spring 1980. "A New Look At The Dating Of Early English Clocks", C. N. Ponsford and J. G. M. Scott. Although this example is from the late 1500's, this design was known much earlier. Porlock, Somerset, England.

4. Antiquarian Horology, vol. 14, no. 6, June 1984. Pg. 626. Under individual AHS Sections reports the Turret Clock Group made a field trip to (sic) 'Left to last is what was considered by most members present to be the most interesting clock so far described. This was a TRUE (their emphasis) flat-bed at Argory in Belfast by Waugh and Sons of Dublin, 1820. Of superb proportions it showed considerable French influence. Described by one person as "super", this clock could well rank high on the list of contenders for the first flat bed clock turret clock in the United Kingdom.' Photographic evidence not being available, I can only add this as a footnote and a contender.

5. *Antiquarian Horology*, vol. 11, no. 2, Winter 1978
6. Clock installed at St. Luke's church in West Norwood, England.

### **Remontoire**

1. See internet site Delightful Machines, <http://www.database.com/~lemur/dmh-frodsham-remontoire.html> . This site may be unavailable. If so contact the author for a copy.
2. Often one will hear the term 'constant force escapement' or 'remontoire escapement' used interchangeably with 'remontoire'. This is misleading. A remontoire on its' own is a device that functions only to deliver a constant force and isolate from the rest of the wheel train regardless of whatever escapement is employed to control the balance wheel or pendulum. The two are separate in both form and function. They contain their own auxiliary power supply in the form of weight or spring, and if the main weight is removed, the escapement will continue to be powered until the remontoire is ready to cycle. Typically 30 to 60 seconds. Remontoire escapements operate as part and parcel of the escapement itself. So if the main weight is removed the escapement will cease to be powered on the next swing of the pendulum. One such named escapement is the gravity escapement (see section on escapements; the Dennison double three-legged gravity). A few tower clock makers, Cooke & Sons; Gillette & Bland to name a couple of English makers, used a remontoire in addition to their gravity escapements in their exceptional first tier clocks.
3. *Antiquarian Horology*, vol.11, no.1, Autumn 1978. "Constant Force Escapements and an Escapement Remontoire", Anthony G. Randall. It is generally credited that the earliest remontoire was made by Jost Burgi in a clock for the Landgraf of Hessen Cassel, William IV during the period of 1585-1592, so circa 1590. This clock had a refined verge escapement, it was pre cross beat and of course pre balance spring, and it also had the rather crude gearing (tooth profile) of the period. The remontoire in the train provided a means of improving the accuracy of the clock sufficiently over periods of 24 hours or so to enable Burgi to make his astronomical observations.
4. From original US Patent Office drawing. Patent number 421,622 awarded to Mathias Schwalbach February 18, 1890.
5. All remontoire line illustrations, except that for spring remontoire, from *Les Horologes d' Edifice*, Alfred Ungerer. c.1926. Gravity remontoire, pg. 100, gravity differential, pg. 101, Robin, endless chain, pg. 95, Rocker, Verite, pg. 98.
6. *Antiquarian Horology*, vol. 2, no.1, December 1956. The Origin of the Differential Gear, Dr. H. V. Bertele. The article states that the earliest known use of the differential gear applied to a clock was made by Joseph Williamson between 1720-1725. In this case it was used in the equation work and not as a remontoire.

### **Strike work**

1. *Antiquarian Horology*, vol. 12, no. 1, Spring 1980. "A New Look at the Dating of Early English Clocks", C. N. Posford and J. G. M. Scott. First example "at Dunstable Priory, Bedfordshire, in 1283, and then at Exeter Cathedral in 1284".
2. Perpignan 1356, The Making of a Clock and Bell for the King's Castle, C. F. C. Beeson. (Sic.) In 1387 an account is given in connection with the clock at the Royal Palace of Perpignan, the clock which was designed to strike the hours was so unreliable that two men were employed to strike the hours manually instead, as was also being done at the cathedral in Barcelona where two men were paid for performing a similar duty. According to a document sent by King Jean I, dated August 28, 1387, they were to live within the tower of the cathedral and 'they will each take turn, one from noon to midnight, the other from midnight to noon for an annual salary of 360 Sous; they will stay in the tower where they will be provided with a sandglass; one hour after starting his service, the first will sound one blow, an hour later he will sound two blows, then three blows and so on up to twelve blows; he will be replaced by his companion who will carry out the same hour by hour...' What an existence!
3. *Antiquarian Horology*, vol. 10, no. 1, Winter 1976. "Rye Church Clock", E. J. Tyler.
4. *English Church Clocks 1280 - 1850*, C. F. C. Beeson.
5. *Antiquarian Horology*, vol. 28, no. 5, March 2005. "Who Invented Rack and Snail Striking? The Early Development of Repeating and Rack Striking", John H. Robey, pg. 584-601. In this article it is argued that while Barlow was the inventor of the snail, the rack and it's function as a gathering pallet as well as the ability of the system as a whole to repeat upon demand, was an amalgam of efforts on the part of Thomas Thompion, Joseph Knibb as well as Edward Barlow.
6. Huygens' Legacy - The Golden Age of the Pendulum Clock, catalog of the exhibition at the Het Loo Palace, Apeldoorn, Netherlands, September 12 through November 28, 2004 and sponsored by the National Museum, pg. 217.
7. *The Almanus Manuscript*, J. H. Leopold.
8. *Antiquarian Horology*, vol. 12, no. 6, June 1981.

### **Winding Systems**

1. *Antiquarian Horology*, vol. 11, no. 2, Winter 1978. "Early Pendulum Clocks", Ronald A. Lee.
2. *The Quest for Longitude*, William J. Andrews.
3. *Antiquarian Horology*, vol. 1, supplement. "Clockwork Before the Clock", Dr. Derek J. Price, Oct. 5, 1955



## Photo Credits (in order of their appearance)

### Introduction:

- Cover –Author’s collection, E. Howard & Co. model #1, Boston MA, c.1895
1. [http://www.2atoms.com/weird/images/antikhytera\\_device.jpg](http://www.2atoms.com/weird/images/antikhytera_device.jpg)
  - 2, 4, 5. <http://www.mlahanas.de/Greeks/Kythera-Dateien/image009.jpg>
  3. <http://www.perseus.tufts.edu/GreekScience/Students/Jesse/antik.gif>
  6. Antiquarian Horology, March 1982, pg. 252
  7. Turmuhwerke, Bernard Schmidt, pg. 37, unknown
  8. Turmuhwerke II, Bernard Schmidt, pg. 128, unknown, Salisbury, England, 1386
  - 9,10. <http://www.answers.com/topic/astronomical-clock>
  11. Antiquarian Horology, Spring 1980, pg. 53
  12. Turmuhwerke, Bernard Schmidt, pg. 15, Hans Dalhof, 1510
  13. Turmuhwerke, Bernard Schmidt, pg. 104, Alprecht Hener, Merzen, Germany, 1569
  14. Turmuhwerke II, Bernard Schmidt, pg. 58, Luterer
  15. Turmuhwerke II, Bernard Schmidt, pg. 38, Hofmann, Dorflis, Germany, 1803
  16. Turmuhwerke II, Bernard Schmidt, William Clement, London 1671
  - 17, 18, 19, 20. Edward John Dent and His Successors, Vaudrey Mercer, pg.379, 384, 383, 382
  21. The Triumphs of Big Ben, John Darwin, pg. 128c
  22. Author’s photo files, John Moore of Clerkenwell, England, 1866
  23. Turmuhwerke II, Bernard Schmidt, pg. 31, Phillip Horz, Ulm, Germany, c 1880's
  24. Turmuhwerke II, Bernard Schmidt, pg. 49, Kurzman, Vienna, Austria, 1910
  25. Author’s collection, ‘Big Ben’ working model, 1:6 scale
  26. Turmuhwerke II, Bernard Schmidt, pg. 64, Michaels, Mechelen, Belgium, 1926
  27. Author’s photo files, unknown
  28. Author’s photo files, Seth Thomas, USA
  29. Author’s photo files, E. Howard, USA
  30. Turmuhwerke, Bernard Schmidt, pg. 155, Edward Korfhage, 1935
  31. Turmuhwerke II, Bernard Schmidt, pg. 35, Phillip Horz, Ulm, Germany, c. 1930
  32. Turmuhwerke II, Bernard Schmidt, pg. 86, Rochlitz, Berlin, Germany c.1940
  - 33,34,35,36 author’s collection

### Frame Styles:

1. Antiquarian Horology, Spring 1980, pg. 53
2. Antiquarian Horology, March 1982, pg. 284
3. Antiquarian Horology, Spring 1980, pg. 61
4. Turmuhwerke, Bernard Schmidt, pg. 104, Alprecht Hener, Merzen, Germany, 1569
5. Author’s collection, Dutch, c. mid 1500's, conversion from folio to anchor
6. Author’s collection, Dutch c. 1660
7. Turmuhwerke II, Bernard Schmidt, pg. 134, unknown, c.1800
8. Author’s collection, German, c. early 1800's
9. Turmuhwerke II, Bernard Schmidt, pg. 130
- 10,11. Author’s collection, Thwaites & Reed, Clerkenwell, England, 1836
12. Author’s collection, J. F. Weule, Bockenem (Harz), Germany, c.1900
13. Author’s collection, Whitehurst, Derby, c.1880
14. Author’s collection, Edward Korfhage, Buer, Germany, 1952
15. Author’s photo files, J. F. Weule, Bockenem (Harz), Germany, c.1880's
16. Author’s collection, Phillip Horz, Ulm, Germany, 1880's
17. Author’s collection, Mathias Schwalbach, Wisconsin, USA, 1890
18. Author’s photo files, Arsine Cretin, Morbier (Jura), France, c. 1890
19. Author’s collection, John Smith, Clerkenwell, England, c.1880's
20. Author’s photo files. Bailey, Salford, England, c1870
21. Turmuhwerke, Bernard Schmidt, pg. 56, Michaels, Germany 1900
22. Author’s collection, Collin-Wagner, Paris, France, c.1870's
23. Author’s collection, Gourdin, Mayat, France, 1890's
24. Author’s collection, Arsine Cretin, (Victor Negre retailer), Morbier (Jura), France, 1905
25. Author’s collection, Louise-Delphin Odobey, Jura, France, 1897
26. Author’s collection, Seth Thomas, Connecticut, USA, model #14, 1910
27. Author’s collection, Arsine Cretin, Morbier (Jura), France, 1933

28. Author's collection, John Smith, Clerkenwell, England, 1874
29. Author's collection, Edward Korfhage, Buer, Germany, 1950
30. Author's collection, unknown probably English, c.1880's
31. Author's collection, Johannes Ritzert, Ulmstadt, Germany, 1893
32. Turmuhwerke, Bernard Schmidt, pg. 167, unknown
33. Author's collection, Benedikt Schneider, Schonach, Germany, c.1890
34. Author's collection, George Seybold, Landau, Germany, c.1900

#### **Escapements:**

1. Antiquarian Horology, December 1999, cover Dover Castle, England, c.1600
2. Author's collection, Holland, c.1670
3. <http://www.bricksandbrass.co.uk/decfeat/dfclock/clkescape.htm>
- 4,5. Antiquarian Horology, Summer 1979, pg. 375, 377
6. Author's collection, Holland, c.1670
7. Turmuhwerke II, Bernard Schmidt, pg. 99, Trainer, German, 1751
8. Author's collection, Holland, c. mid 1500's, conversion from folio to anchor
9. Author's collection, Johannes Ritzert, Ulmstadt, Germany, 1893
10. Author's collection, Edward Korfhage, Buer, Germany, 1940
11. Author's collection, Collin-Wagner, Paris, France, c. 1870
12. Author's collection, William Potts, Leeds, England, 1900
13. Turmuhwerke, Bernard Schmidt, pg. 54, Joseph Mannhardt, Munich, Germany, c.1862
14. Die Turmuhren, Curt Diezfeld, Table 7.
15. Author's collection, George Seybold, Landau, Germany, c.1900

#### **Remontoire:**

- 1,2. Author's collection, Mathias Scwalbach, Wisconsin, USA, c.1890's
- 3,4. From US Patent Office abstracts, patent No. 421,622 and dated February 18, 1890.
- 5,6. Author's collection, Collin-Wagner, Paris, France, c. 1870
7. Les Horologes d'Edifice, Alfred Ungerer, pg. 100
- 8,9. Author's collection, Edward Korfhage, Buer, Germany, 1940
10. Les Horologes d'Edifice, Alfred Ungerer, pg. 101
- 11,12. Author's collection, Heinrich Perrot, Calw, Germany, 1952
13. Author's collection, Phillip Horz, Ulm, Germany, c.1890
14. Les Horologes d'Edifice, Alfred Ungerer, pg. 95
15. Turmuhwerke, Bernard Schmidt, pg. 124
- 16,17,19. Author's collection, J.H. Addicks, Amsterdam, Holland, c.1930's
18. Les Horologes d'Edifice, Alfred Ungerer, pg. 98
- 20,21,22. Author's collection, George Seybold, Landau, Germany, c.1900

#### **Striking systems:**

- 1,2,3. Turmuhwerke II, Bernard Schmidt, pg. 169
4. English Church Clocks 1280 - 1850, C.F.C. Beeson, pg. 82
- 5,6. Antiquarian Horology, Spring 1980, pg. 55, 53
7. English Church Clocks 1280 - 1850, C.F.C. Beeson, pg. 82
8. The Almanus Manuscript, J.H. Leopold, pg. 23
9. Author's collection, John Smith, Clerkenwell, England, 1874
10. Les Horologes d'Edifice, Alfred Ungerer, pg. 121
11. Author's collection, Johannes Ritzert, Ulmstadt, Germany, 1893
12. Author's collection, Arsine Cretin, Morbier (Jura), France, 1933
13. Author's collection, Collin-Wagner, Paris, France, c. 1870
14. Les Horologes d'Edifice, Alfred Ungerer, pg. 112
15. Author's collection, Louise-Delphin Odobey, Jura, France, 1897
16. Les Horologes d'Edifice, Alfred Ungerer, pg. 110
17. Author's collection, Seth Thomas, Connecticut, USA, 1910
18. Author's collection, Thwaites & Reed, Clerkenwell, Britain, 1836
19. Antiquarian Horology, December 1985, pg. 597
- 20,21. Antiquarian Horology, June 1981, pg. 637, 638,

#### **Winding systems:**



1. Turmuhwerke II, Bernard Schmidt, pg. 128, Dover Castle, England, c.1600
2. Antiquarian Horology, Spring, 1980, pg. 65
3. Turmuhwerke II, Bernard Schmidt, pg. 147
4. Author's collection, Johannes Ritzert, Ulmstadt, Germany, 1893
5. Author's collection, John Smith, Clerkenwell, Britain, c.1880's
6. Turmuhwerke II, Bernard Schmidt, pg. 148
7. Author's collection, John Smith, Clerkenwell, Britain, c.1880's
8. The Turret Clock Keeper's Handbook, Cris McKay, pg. 14
- 9, 10. Turmuhwerke II, Bernard Schmidt, pg. 32
11. Les Horologes d'Edifice, Alfred Ungerer, pg. 138
- 12,13. Turmuhwerke II, Bernard Schmidt, pg. 147
14. Les Horologes d'Edifice, Alfred Ungerer, pg. 95
- 15,16. Author's collection, Arsine Cretin, Morbier (Jura), France, 1933
17. Author's collection, Johanne Manhardt, Munich, Germany 1899
- 18, 19. Les Horologes d'Edifice, Alfred Ungerer, pg. 86
- 20,21. Author's collection, Gillette & Co., Croydon, England, c.1870's
22. Author's collection, Phillip Horz, Ulm, Germany, c. 1880
23. Author's collection, Seth Thomas, Connecticut, USA, model #14, 1910
24. Author's collection, E. Howard, Massachusetts, USA, model #1, c.1895
25. Les Horologes d'Edifice, Alfred Ungerer, pg. 84
26. Turmuhwerke II, Bernard Schmidt, pg. 148
27. Author's collection, Edward Korfhage, Buer, Germany, 1952
28. Les Horologes d'Edifice, Alfred Ungerer, pg. 140

**Tower installations:**

1. Les Horologes d'Edifice, Alfred Ungerer, pg. 140
2. Seth Thomas Clocks & Movements, Tran Duy Ly, pg. 370
3. E. Howard & Co. catalog
- 4,5,6,7. Turmuhwerke II, Bernard Schmidt, pg. 132