

**hp**  
photosmart  
430 series  
digital camera  
with  
hp instant  
share



user's manual





## Trademark and copyright information

© Copyright 2003 Hewlett-Packard Development Company, LP  
Reproduction, adaptation, or translation without prior written permission is prohibited, except as allowed under the copyright laws.

The information contained in this document is subject to change without notice. Hewlett-Packard shall not be liable for errors contained herein or for consequential damages in connection with the furnishing, performance, or use of this material.

Microsoft® and Windows® are U.S. registered trademarks of Microsoft Corporation.

Apple®, Macintosh®, and Mac® are registered trademarks of Apple Computer, Inc.

MultiMediaCard™ is a trademark of Infineon Technologies AG.

SD logo is a trademark.





# Table of Contents

<b>Chapter 1:</b>	
<b>Getting started</b> .....	<b>9</b>
Camera parts .....	10
Setup .....	14
Attaching the wrist strap .....	14
Installing the batteries .....	14
Installing a memory card (optional) .....	15
Turning on power .....	16
Restoring previous settings .....	16
Choosing the language .....	16
Setting the date and time .....	17
Installing the software .....	18
Windows .....	18
Macintosh .....	19
Understanding the status screen .....	20
<b>Chapter 2:</b>	
<b>Taking pictures and recording video clips</b> .....	<b>21</b>
Taking still pictures .....	21
Recording video clips .....	22
Using live view .....	23
Using digital zoom .....	24
Using the flash .....	25
Recording audio .....	26
Changing capture modes .....	27
Using self-timer mode .....	28
Advanced capture settings .....	29
Changing the image quality .....	30
EV compensation .....	31
White balance .....	32
ISO speed .....	33
Color .....	34

Setup	34
<b>Chapter 3:</b>	
<b>Reviewing images and video clips</b>	<b>35</b>
Using playback	35
Using the playback menu	37
Viewing thumbnails	38
Rotating images	39
Deleting images	40
Recording and deleting audio clips	41
Magnifying images	42
Setup	42
<b>Chapter 4:</b>	
<b>Using hp instant share</b>	<b>43</b>
Using the share menu	44
Using hp instant share to print photos	45
Using hp instant share to send images to destinations	46
Adding destinations to the share menu on the camera	46
Selecting hp instant share destinations for images	49
How hp instant share e-mails images	50
<b>Chapter 5:</b>	
<b>Unloading, printing, and displaying images</b>	<b>51</b>
Unloading to a computer	51
Printing images	53
Displaying images on a TV	55
<b>Chapter 6:</b>	
<b>Using the setup menu</b>	<b>57</b>
Camera sounds	58
Date & time	58
USB configuration	59
TV configuration	60

Language	60
Move images to card	61
<b>Chapter 7:</b>	
<b>Troubleshooting and support</b>	<b>63</b>
Problems and solutions	63
Error messages on the camera	72
Error messages on the computer	79
Getting assistance	81
HP accessibility website	81
HP photosmart website	81
Support process	81
Phone support in the United States	83
Phone support in Europe, the Middle East, and Africa	84
Other phone support worldwide	86
<b>Appendix A:</b>	
<b>Batteries and camera accessories</b>	<b>89</b>
Managing batteries	89
Rechargeable batteries	91
Extending battery life	92
Power conservation	92
Purchasing camera accessories	93
<b>Appendix B:</b>	
<b>Specifications</b>	<b>95</b>





# Chapter 1: Getting started

Congratulations on your purchase of this digital camera! This camera has many features to enhance your picture-taking experience, including HP Instant Share™, direct printing capability, manual and automatic controls, on-camera Help, and an optional camera dock.

With HP Instant Share, you can easily select pictures on your camera to print or e-mail automatically the next time you connect the camera to your computer or printer. Your friends and family can easily receive and view your pictures in e-mail without being burdened by large file attachments. Or you can use the direct printing capability to any HP Photosmart printer or other select HP printer without ever connecting to your computer. What a great way to keep others close as you capture precious memories!

To further enhance your experience, you may purchase an HP Photosmart 8886 camera dock. The camera dock allows you to easily download images to a computer, send images to a printer or television, and recharge the camera batteries. It also provides a convenient home for your camera.

**NOTE** A dock insert is included in your camera box. Please do not discard it, because it enables your camera to use the HP 8886 camera dock. See the manual that comes with the camera dock for instructions on how to attach the dock insert to the camera dock.







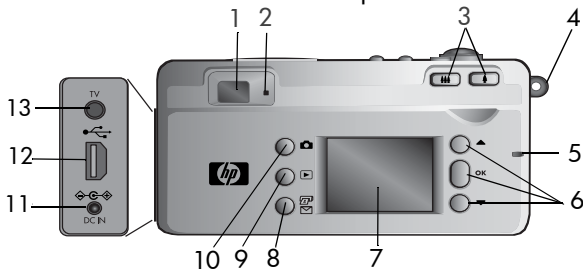

# Camera parts

**NOTE** Refer to the pages in parentheses after the part names for more information about those parts.





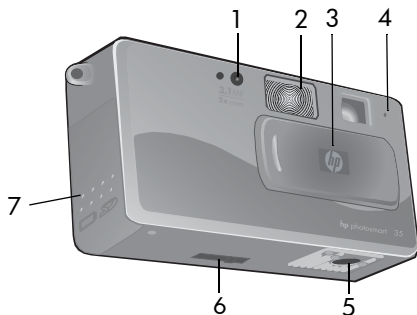

#	Name	Description
1	Optical Viewfinder (page 21)	Allows you to frame the subject of the picture or video clip
2	Viewfinder light	<ul style="list-style-type: none"> <li>● <b>Solid red</b>—camera is recording video</li> <li>● <b>Blinking red</b>—Self-Timer is counting down, the flash is charging, image is being processed, or there is an error (see Image Display for message)</li> </ul>
3	⏪ Zoom Out and ⏩ Zoom In lever (page 24)	Controls digital zoom.
4	Wrist strap mount (page 14)	Allows you to attach a wrist strap
5	Memory/USB light (page 16)	<ul style="list-style-type: none"> <li>● <b>Solid green</b>—Camera is on or USB is connected</li> <li>● <b>Blinking green</b>—camera is either: starting up, charging the battery, sending/receiving USB, or reading from or writing to the memory card</li> </ul>

#	Name	Description
6	 arrow buttons and OK button (page 29, 37)	<ul style="list-style-type: none"> <li>● —allows you to move through menus and images on the Image Display</li> <li>● OK—allows you to display the <b>Capture</b>, <b>Playback</b>, and <b>Setup</b> menus and to select menu options</li> </ul>
7	Image Display (page 23, 35)	Allows you to frame pictures and video clips using <b>Live View</b> and review them afterward in <b>Playback</b> , and to view all the menus
8	 /  <b>Share</b> button (page 43)	Turns the <b>Share</b> menu on and off on the Image Display
9	 <b>Playback</b> button (page 35)	Turns <b>Playback</b> on and off on the Image Display
10	 <b>Live View</b> button (page 23)	Turns <b>Live View</b> on and off on the Image Display
11	Power adapter connector (page 93)	Provides connection for optional HP C8912 AC power adapter
12	USB connector (pages 51, 53)	Provides connection for USB cable to a computer or printer
13	TV connector (page 55)	Provides connection for optional Audio/Video cable to a TV

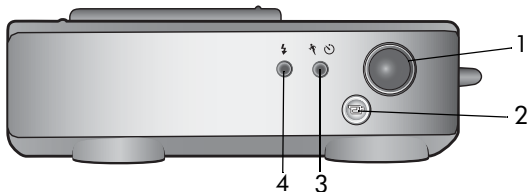

#	Name	Description
1	Video/Self-Timer light (page 22, 28)	<ul style="list-style-type: none"> <li>● <b>Solid red</b>—camera is recording video</li> <li>● <b>Blinking red</b>—<b>Self-Timer</b> is activated</li> </ul>
2	Flash (page 25)	Provides additional light to improve picture-taking
3	Lens cover/ power switch (page 16)	Protects the camera lens from dust, and turns the camera on and off
4	Microphone (pages 26, 41)	Records audio clips
5	Tripod mount	Allows you to mount the camera to a tripod
6	Camera dock connector (page 93)	Provides connection to the optional HP 8886 camera dock
7	Battery/ memory card door (page 14)	Allows access to insert and remove the batteries and memory card



#	Name	Description
1	<b>Shutter</b> button (page 21)	Takes a picture. Push all the way down to take picture. Hold down after picture is taken to record audio.
2	 <b>Video</b> button (page 22)	Records a video clip; press once to start and press again to stop
3	 <b>Mode</b> button (page 27)	Changes the capture mode to <b>Self-Timer</b> , <b>Action</b> , or <b>Normal</b> settings.
4	 <b>Flash</b> button (page 25)	Selects the flash setting

# Setup

## Attaching the wrist strap

Attach the wrist strap to the wrist strap mount on the side of the camera as shown.

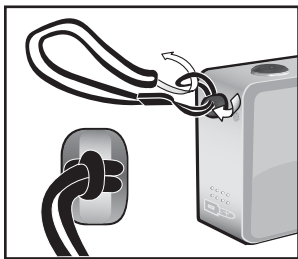

## Installing the batteries

- 1 Open the battery/memory card door on the side of the camera.
- 2 Insert the batteries as indicated inside the door.
- 3 Close the battery/memory card door.

**NOTE** For more information about the best types of batteries to use, see **Managing batteries** on page 89.

**NOTE** If you have rechargeable batteries, you can use the optional HP Photosmart 8886 camera dock or the optional HP AC power adapter to recharge the batteries while they are in the camera. For more information about these optional accessories, see **Purchasing camera accessories** on page 93.

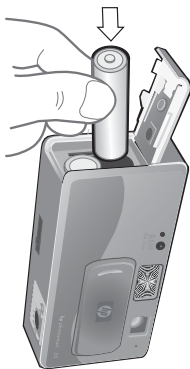

## Installing a memory card (optional)

Your camera contains 16 MB of internal memory that allows you to store images and video clips in your camera. However, you can also use an optional memory card (purchased separately) instead to store images and video clips. For information on the memory cards that are supported with your camera, see **Purchasing camera accessories** on page 93.

**NOTE** If a memory card is installed in the camera, all new images and video clips will be stored only on the memory card. The camera's internal memory is not used when a memory card is installed in the camera.

- 1 Turn the camera off, then with the camera turned upside down, open the battery/memory card door on the side of the camera.
- 2 Insert the memory card, making sure that it clicks into place.
- 3 Close the battery/memory card door.

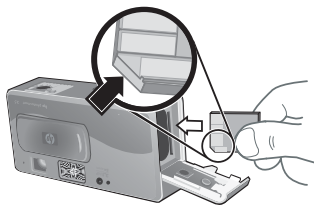

To remove a memory card, turn the camera off and open the memory card door, then push the memory card in and it will spring outward from the slot.

## Turning on power

Turn the camera on by sliding the lens cover/power switch open so that the camera lens is exposed. The Memory/USB light will blink while the camera is turning on, and the Image Display will turn on to Live View mode when the camera is ready to use.

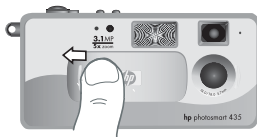

## Restoring previous settings

When you change settings in the camera, some of them remain set and some return to their default value when the camera is turned off. For a complete list of which settings do what, see **Remembered and default camera settings** on page 97.

If you want to turn the camera on with all of the settings that were in effect when the camera was last turned off, hold down the OK button when you turn on the camera.

## Choosing the language

The first time you turn the camera on, the following screen appears and prompts you to choose a language.

- 1 Scroll to the language that you want by using the ▲ ▼ buttons.
- 2 Press the OK button to select the highlighted language.



**NOTE** If you need to go back and change this setting later, you can do this in the **Setup** menu. See **Chapter 6: Using the setup menu** on page 57.



## Setting the date and time

The camera has a clock that records the date and time at which you take each picture. This time stamp does not appear in the image itself, but is recorded in the image properties, which you can see when viewing the image on the computer.

The first time you turn the camera on, the following screen appears after you choose the language.

- 1 Press the **OK** button repeatedly until the preferred date format appears, and then press the **▼** button to highlight the date.
- 2 Press **OK** to select the first value, and then use the **▲** **▼** buttons to change it. Press **OK** to confirm. Set the remaining values in the same way (M = Month, D = Day, Y = Year).
- 3 Press the **▼** button to highlight the time format, and then press **OK** if you want to change it.
- 4 Press the **▼** button to highlight the time. Set the time values in the same way you set the date values in step 2.
- 5 When finished setting the date and time, press the **▼** button to highlight **Exit**, and then press **OK**.



**NOTE** If you need to go back and change this setting later, you can do this in the **Setup** menu. See **Chapter 6: Using the setup menu** on page 57.

## Installing the software

The camera software allows you to unload images from the camera, view them, print them, and e-mail them. It also allows you to configure the **Share** menu on the camera.

See **Chapter 4: Using hp instant share** on page 43 for information about configuring the **Share** menu on the camera, and **Chapter 5: Unloading, printing, and displaying images** on page 51 for information about connecting the camera to a computer or printer.

**NOTE** A copy of this User's Manual is located on the HP Photo & Imaging software CD. Look in the `\docs\Readme` file on the CD to see where the manual in your language is located.

## Windows

**NOTE** For the **HP Instant Share** component of the HP Photo & Imaging software to function properly on your Windows computer, you must have installed at least Internet Explorer 5.01 on Windows 2000 or XP, or Internet Explorer 5.01 Service Pack 2 on Windows 98, 98 SE, or Me.

- 1 Close all programs and temporarily disable any virus protection software running on your computer.
- 2 Insert the HP Photo & Imaging software CD into the CD drive of your computer. The installation window automatically appears.

**NOTE** If the installation window does not appear, click **Start**, and then click **Run**. Type `X:\Setup.exe`, where **X** is the letter of your CD drive.

- 3 Click **Next**, and then follow the on-screen instructions to install the software.

Your Windows CD may also include bonus software from other manufacturers. To install any bonus software:

- 1 Click **Start**, click **Run**, and in the **Open** box, type **X:\Bonus\setup.exe** (where **X** is the letter of your CD drive).
- 2 Click **OK**, and then follow the on-screen instructions to install the bonus software.

## **Macintosh**



- 1 Close all programs and temporarily disable any virus protection software running on your computer.
- 2 Insert the HP Photo & Imaging software CD into the CD drive of your computer.
- 3 Double-click the CD icon on the computer desktop.
- 4 Double-click the installer icon, and then follow the on-screen instructions to install the software.

**NOTE** Before you can unload images from the camera to a Macintosh computer, you must first change the **USB Configuration** setting to **Disk Drive** in the **Setup** menu on the camera. See **Chapter 6: Using the setup menu** on page 57, and then see **USB configuration** on page 59.

Your Macintosh CD may also include bonus software from other manufacturers. To install any bonus software:

- 1 Double-click the **Bonus** folder icon.
- 2 Double-click the installer icon for the bonus software.
- 3 Follow the on-screen instructions to install the software.









## Understanding the status screen

The status screen appears for several seconds any time you press the **Flash**  button or the **Mode**   button. See **Using the flash** on page 25 and **Changing capture modes** on page 27.

The main part of the status screen shows the current **Image Quality** setting, pictures remaining, battery level (or AC adapter), flash setting, and the current capture mode setting (**Self-Timer**, **Action**, or **Normal**).



Here is the list of icons you might see on the status screen and what they mean.

Icon	Indicates
★★★★	Image quality selection
A 	Auto flash is active
	Red-eye Reduction Flash is active
	Flash On is active
	Flash Off is active
	Night flash setting is active
0000	Number of still images remaining
	AC adapter is providing power
	Battery level
	Action mode is active
	Self timer setting is active

# Chapter 2:

## Taking pictures and recording video clips

### Taking still pictures

You can take a picture almost any time the camera is on, regardless of what is being shown on the Image Display.

- 1 Frame the subject for your picture in the viewfinder.
- 2 Press the **Shutter** button all the way down to take the picture.





The captured image appears for several seconds on the Image Display for instant review. During this time, the image is saved to memory, unless you choose to delete it by pressing the **OK** button.

In Step 2 above, the Viewfinder light may start blinking. For an explanation of this, see the description for the Viewfinder light on page 10.

**NOTE** The Memory/USB light will blink while the camera is saving pictures to internal memory or the memory card, and the camera may not respond to button presses during this time. Do not remove the memory card while this light is blinking, because it might corrupt the card.

# Recording video clips

- 1 Frame the subject for your video in the viewfinder.
- 2 Press and release the **Video**  button to start recording video. Both the red viewfinder light and the Video/Self-Timer light will turn on solid. A video  icon and a Time Remaining counter appear at the top of the Image Display.



**NOTE** If you have the Self-Timer mode on (see **Using self-timer mode** on page 28), the camera will start recording 10 seconds after you press the  button.

- 3 To stop recording, press the  button again.

The length of a video clip is limited only by the amount of available memory. The camera calculates the time remaining (mm:ss) counter based on the amount of available memory (internal or memory card). The video ends when time remaining reaches zero or the  button is pressed again.

After recording has stopped, the last frame of the video clip remains on the Image Display for instant review. During this time, the video clip is saved to memory unless you choose to delete it by pressing the **OK** button.

**NOTE** Audio is automatically recorded with video clips.



## Using live view

You can use the Image Display as a viewfinder to see a more accurate view of what your picture or video will look like. This is useful for close-up pictures and for instances in which framing your subject precisely is important.

**NOTE** Using **Live View** consumes a lot of battery power. To preserve batteries, use the viewfinder instead.

To turn on **Live View**, press the **Live View**  button. The following table describes the information that is displayed in the **Live View** screen when the camera settings are at their default values.



#	Icon	Description
1	★★	Current image quality setting. If you press the <b>Video</b> button, the video icon (  ) appears in this location.
2	24	Remaining pictures count (depends on space remaining in memory). If you press the <b>Video</b> button, the time remaining for a video clip appears here.
3	A ⚡	Auto flash icon will blink when the flash is charging.
4	 or 	<ul style="list-style-type: none"><li>• Battery level (actual icon shown depends on the state of your camera batteries).</li><li>• Camera is using AC power from the optional HP 8886 camera dock or AC power adapter.</li></ul>

**NOTE** If you change other camera settings, icons for those settings will also be displayed across the top and bottom of the **Live View** screen. For more information, see **Advanced capture settings** on page 29.

## Using digital zoom

**NOTE** Digital zoom does not work while recording video clips.

With digital zoom, the camera essentially crops the image, then enlarges the image to give the appearance of the object in the picture being closer.

**NOTE** The HP 433 camera has 3x digital zoom, and the HP 435 camera has 5x digital zoom.

- 1 Press the **Zoom in**  button and hold it until you reach the desired size on the Image Display. The picture enlarges on the Image Display. The amount of digital zoom appears at the bottom of the Image Display.



- 2 Press the **Shutter** button to take the picture.





**NOTE** Digital zoom reduces the resolution of an image, so your picture will tend to be more pixilated (grainy) than the same image taken without digital zoom. If you just intend to e-mail an image or post it to a website, this loss of resolution will not be noticeable, but in situations where the highest quality counts (such as printing), skip the digital zoom and try to get physically closer to the subject of your picture.



# Using the flash

**NOTE** The flash does not work while recording video clips.

To change the flash setting, press the **Flash** ⚡ button on the top of the camera until the desired setting appears on the Image Display. The camera remains in the current flash setting until you change it or turn off the camera.

Icon	Setting	Description
	Auto	The camera measures the available light and fires the flash if necessary. This is the default setting.
	Red-eye Reduction	The camera measures light and fires the flash with red-eye reduction if necessary.
	Flash On	The camera always fires the flash. If the light is behind your subject, use this setting to increase the light on the front of your subject. This is called “fill-flash”.
	Flash Off	The camera will not fire the flash. Use this setting when you do not want a flash (such as with distant objects). This may result in long exposures that will require using a tripod.
	Night	The camera fires the flash to illuminate objects in the foreground. It then continues to expose as if the flash had not fired to gather the background. This setting only works when taking pictures of still objects. Hold the camera steady to prevent blurry images. For best results, use a tripod.

# Recording audio

**NOTE** This section applies only to still pictures. Audio is automatically recorded with video clips.

There are two ways to attach an audio clip to a still picture.



- Record the audio while you are taking the picture (explained in this section).
- Add an audio annotation to the picture later (or change the audio that was captured when the picture was taken). For details on how to do this, see **Recording and deleting audio clips** on page 41.

- 1** Press the **Shutter** button down to take the picture (audio starts recording automatically).
- 2** Continue to hold the **Shutter** button down to record the audio clip. If you let up on the **Shutter** button within two seconds of taking the picture, then the audio clip is discarded. If you keep holding the **Shutter** button down, the audio will continue recording as long as there is enough memory available. A microphone icon (  ) and an elapsed time counter appear in the middle of the Image Display during recording.
- 3** To stop recording, release the **Shutter** button.

To record a new audio clip, or to delete an audio clip, use the **Record Audio** section in the **Playback** menu. See **Using the playback menu** on page 37.



**NOTE** To listen to audio clips, you must download the images from the camera to your computer, then use the HP Photo & Imaging software. You can also display images from the camera to a TV as a slideshow. See **Chapter 5: Unloading, printing, and displaying images** on page 51.

# Changing capture modes



The **Mode**   button on the top of the camera sets the camera to one of three different capture modes. Each time you press this button, the camera changes to the next capture mode. The sequence for the different settings is: **Self-Timer**, **Action**, **Normal**, and then repeat.



**NOTE** These settings do not have any effect on recording video clips unless specifically noted otherwise.

Each time you change the capture mode, an icon representing that capture mode appears on the Image Display. The following table describes these different icons.

Icon	Setting	Description
	<b>Self-Timer</b>	Camera waits 10 seconds after the <b>Video</b> button or <b>Shutter</b> button is pressed to take a video clip or a picture. See <b>Using self-timer mode</b> on page 28.
	<b>Action</b>	Camera biases toward faster shutter speeds and higher ISO speeds to stop action.
None	<b>Normal</b>	Camera automatically selects aperture and shutter speed. This is the default setting when the camera is first turned on.

## Using self-timer mode

- 1 Secure the camera to a tripod or set it on a stable surface.
- 2 Press the **Mode**   button on the top of the camera until the **Self-Timer**  icon appears on the Image Display.
- 3 Frame the subject in the viewfinder.
- 4 The next steps depend on whether you are capturing a still picture or a video clip.

When capturing:	Procedure
Still picture	<ol style="list-style-type: none"><li>1 Press the Shutter button down. A 10-second countdown appears on the Image Display.</li></ol> <p>You cannot record audio when using the Self-Timer, but you can add an audio clip to the image later (see <b>Recording and deleting audio clips</b> on page 41).</p>
Video clip	<ol style="list-style-type: none"><li>1 To start recording, press the Video  button and then release it. A 10-second countdown appears on the Image Display.</li><li>2 To stop recording the video clip, press the Video  button again.</li></ol>

**NOTE** The Video/Self-Timer light on the front of the camera blinks before the camera takes the picture or video clip.

# Advanced capture settings

The **Capture** menu allows you to adjust various camera settings that affect the qualities of the images and video clips you capture with your camera. From this menu you can also access the **Setup** menu to set a number of preferences on the camera.

To display the **Capture** menu:

- 1 Press the **Live View** button to turn on **Live View**, then press the **OK** button.
- 2 Use the **▲ ▼** buttons to scroll through the **Capture** menu options.
- 3 Press the **OK** button to select a highlighted option and display its sub-menu.
- 4 Within a sub-menu, use the **▲ ▼** buttons and the **OK** button to change the setting for the **Capture** menu option.
- 5 To exit the **Capture** menu, highlight the **↩ EXIT CAPTURE MENU** option and press the **OK** button.



Each of the **Capture** menu settings is explained in detail on the following pages.

## Changing the image quality

Image quality controls the resolution and compression settings that will be used to capture images. At higher settings, there will be greater detail visible in the images, but the file size of an image will be larger, and thus fewer pictures will fit in the internal memory or on the memory card.

1 In the **Capture** menu, select **Image Quality**.

2 In the **Image Quality** menu, use the ▲ ▼ buttons to highlight one of the quality settings. At the bottom of the Image Display is a **Pictures Remaining** count which shows how the number of remaining pictures is affected by each quality setting.



3 Press **OK** to save the setting and return to **Live View**.

The following table describes the different quality settings:

Setting	Icon	Description and capacity
Good	★	This is the most memory-efficient setting, ideal for images you want to e-mail or post to the Internet.
Better	★★	This setting produces high-quality images and requires less memory than <b>Best</b> setting. This is recommended for printing images up to 20 by 25 cm (8 by 10 inches). This is the default quality setting.
Best	★★★	This setting produces the highest-quality images and uses the most memory. This is recommended if you plan to enlarge images, or print images to a size larger than 20 by 25 cm (8 by 10 inches).

## EV compensation

In difficult lighting conditions, you can use the **EV (Exposure Value) Compensation** setting to override the automatic exposure setting that the camera makes.

**EV Compensation** is useful in backlit scenes involving a person, or in scenes that contain many light objects (like a white house in the snow) or many dark objects (like a black cat on a dark background). Scenes containing many light objects or many dark objects could turn out gray without the use of EV Compensation. For a scene with many light objects, increase the EV Compensation to a positive number to produce a brighter result. For a scene with many dark objects, decrease the EV Compensation to darken the scene to be closer to black.

**1** In the **Capture** menu, select **EV Compensation**.

**2** In the **EV Compensation** menu, use the ▲ ▼ buttons to change the EV setting in 0.5 steps from -2.0 to +2.0. The new setting is applied to the **Live View** screen behind the menu, so you should be able to see the effect the setting will have on the picture.



**3** Press **OK** to save the setting and return to **Live View**.

If the setting is anything other than the default setting of 0 (zero), the number value appears at the top of the **Live View** screen.

The new setting remains in effect until it is changed again or until the camera is turned off.

# White balance

Different kinds of lighting conditions cast different colors. For example, sunlight is more blue, while indoor tungsten light is more yellow. Scenes dominated by a single color may require an adjustment of the white balance setting to help the camera reproduce colors more accurately and ensure that whites appear white in the final picture. You can also adjust the white balance to produce creative effects. Using the **Sun** or **Tungsten** settings can produce a warmer look to the picture, and the **Shade** setting can make a sunset picture look more orange.

**1** In the **Capture** menu, select **White Balance**.

**2** In the **White Balance** menu, use the ▲ ▼ buttons to select a setting. The new setting is applied to the **Live View** screen behind the menu, so you should be able to see the effect the setting will have on the picture.

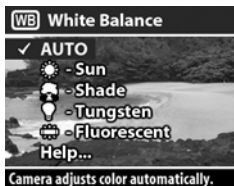



**3** Press **OK** to save the setting and return to **Live View**.

The following table helps explain the settings in more detail.

Icon	Setting	Description
None	Auto	Camera automatically identifies and corrects for scene illuminance. This is the default setting, and the white balance is reset to <b>Auto</b> when you turn the camera off.
	Sun	Camera balances color assuming it is outdoors under sun or bright cloudy conditions.



Icon	Setting	Description
	<b>Shade</b>	Camera balances color assuming it is outdoors in shade, twilight, or dark cloudy conditions.
	<b>Tungsten</b>	Camera balances color assuming incandescent or halogen lighting (typically found in homes).
	<b>Fluorescent</b>	Camera balances color assuming fluorescent lighting.

If the setting is anything other than the default setting of **Auto**, the icon for the setting (in the table above) appears at the top of the **Live View** screen.

The new setting remains in effect until it is changed again or until the camera is turned off.

## ISO speed

The **ISO Speed** setting adjusts the sensitivity of the camera to light. The **Auto** setting works the best.

**NOTE** If the camera is in **Action** mode, the ISO speed will always be set to **Auto** and the ISO option in the **Capture** menu will be grayed out.

Lower ISO speeds will capture the best quality pictures with the least amount of noise or grain. If taking a picture in low light conditions without a flash at ISO 100, you may want to use a tripod.

Higher ISO speeds allow higher shutter speeds and thus can be used when taking pictures in dark areas without a flash, or when taking pictures of fast moving objects and you want to stop action. Higher ISO speeds produce pictures with more grain and thus lower quality.

- 1 In the **Capture** menu, select **ISO Speed**.
- 2 In the **ISO Speed** menu, use the ▲ ▼ buttons to select a setting.
- 3 Press **OK** to save the setting and return to **Live View**.



If the setting is anything other than the default setting of **Auto**, the number value for the setting appears at the top of the **Live View** screen.

The new setting remains in effect until it is changed again or until the camera is turned off.

## Color

This setting determines whether the pictures you take will be full color or black and white.

- 1 In the **Capture** menu, select **Color**.
- 2 In the **Color** menu, use the ▲ ▼ buttons to select a setting.
- 3 Press **OK** to save the setting and return to **Live View**.



**NOTE** Once you have taken a picture using the **Black & White** setting, the image cannot be adjusted back to **Full Color** later.

The default **Color** setting is **Full Color**. The **Color** setting resets to **Full Color** when you turn the camera off.

## Setup









Selecting this **Capture** menu option displays the **Setup** menu. For information about the **Setup** menu, see **Chapter 6: Using the setup menu** on page 57.

# Chapter 3:

## Reviewing images and video clips

You can use the **Playback** feature to review the images and video clips in your camera. In addition, the **Playback** menu allows you to delete images or video clips, rotate or magnify still images, and add, change, or delete audio clips.

### Using playback

- 1 Press the **Playback**  button to activate **Playback** mode. The most recently taken or viewed image or video clip appears on the Image Display.
- 2 Use the   buttons to scroll through your images and video clips. Press and hold the   buttons to scroll automatically.
  - Video clips will play automatically after a few seconds. To replay the video clip, press the  button. Pressing the  button before, during, or after video playback skips to the next image.
- 3 To turn the Image Display off after reviewing your images and video clips, press the **Playback**  button again.





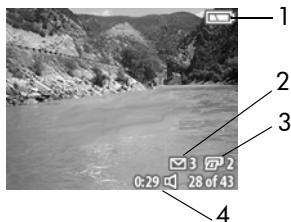

During **Playback**, some information about each image or video clip is also displayed. The following table describes the information.



Still image



Video clip







#	Icon	Description
1	 or 	<ul style="list-style-type: none"> <li>Battery level (actual icon shown depends on the state of your camera batteries).</li> <li>Camera is using AC power from the optional HP 8886 camera dock or AC power adapter.</li> </ul>
2	 3	Indicates this image has been marked for e-mailing using <b>HP Instant Share</b> (this example shows that it will be e-mailed to 3 destinations).
3	 2	Indicates this image has been marked for printing using <b>HP Instant Share</b> (this example shows that 2 copies will be printed).
4	0:29 	Indicates this image has an audio clip and the clip is 29 seconds long.
5	0:37 	Indicates this is a video clip that is 37 seconds long.
6	28 of 43	Shows the current image number from the total number of images taken.

**NOTE** Other icons besides the e-mail  or print  icons may appear, depending on what other destinations have been selected for that image using **HP Instant Share**.

# Using the playback menu

The **Playback** menu allows you to view additional information about each image, rotate still images, delete images, magnify still images, and add, change, or delete audio clips. From this menu you can also access the **Setup** menu to set a number of preferences on the camera.

To use the **Playback** menu:

- 1 Press the **Playback**  button to activate **Playback**, then use the   buttons to move to the image or video clip you want.
- 2 Press the **OK** button to display the **Playback** menu.
- 3 Use the   buttons to highlight the menu options on the left of the Image Display. In order to let you see more of the image you are reviewing, the label of each menu option only appears when you highlight the menu option.

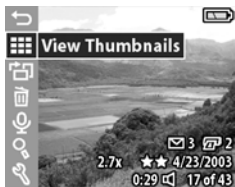

**NOTE** In the **Playback** menu, an additional line of information about the image appears in the lower-right corner of the Image Display. It includes the date the picture was taken, the quality setting used, and the digital zoom setting used (if any).

- 4 To select a highlighted menu option, press **OK**. Each of the **Playback** menu options are explained later in this section.
- 5 To exit the **Playback** menu and return to viewing images in **Playback**, highlight the  **EXIT PLAYBACK MENU** option and press **OK**.

## Viewing thumbnails



This **Playback** menu option lets you see up to nine images at a time, allowing you to quickly navigate to a specific image.

- 1 In **Playback** mode, press **OK** to display the **Playback** menu, then press **OK** again to select the **View Thumbnails** option.
- 2 Scroll through the thumbnail images using the ▲ ▼ buttons. The current image is highlighted with a yellow border. Information about the selected image appears at the bottom of the screen, such as whether it has been selected for **HP Instant Share**, whether it is a video clip, or whether an audio clip is attached to a still image.
- 3 Press the **OK** button to display the currently selected image or video clip in the **Playback** screen.



## Rotating images



**NOTE** This option works only with still images, not video clips.

- 1 In **Playback** mode, select the image you want, then press **OK** to display the **Playback** menu.
- 2 Select the  **Rotate** option and press **OK**. The image you were viewing in **Playback** is automatically rotated 90 degrees clockwise.
- 3 After the image has been rotated, you can rotate it again in either direction using the   buttons.
- 4 When you are ready to save the rotated image, press the **OK** button, and the camera returns to the **Playback** menu.



**NOTE** Before you press the **OK** button in step 4 above, you can cancel the rotation by pressing the **Live View** or **Playback** button.

## Deleting images

- 1 In **Playback** mode, select the image you want to delete, then press **OK** to display the **Playback** menu.
- 2 Select the  **Delete** option and press **OK**.
- 3 In the **Delete** sub-menu, use the   buttons to highlight the option you want, and then press **OK**. These options include:



- **Cancel**—Returns to the **Playback** menu without deleting anything.
- **This Image**—Deletes the currently displayed image or video clip, then returns to the **Playback** menu.
- **All Images in Memory (on Card)**—Deletes all of the images and video clips from internal memory or the memory card, then displays a screen verifying that there are no images left in memory.
- **Format Memory (Card)**—Deletes all of the images, video clips, and files from internal memory or the memory card, and then formats the internal memory or memory card. A screen appears verifying that there are no images left in memory.
- **Undelete**—This appears if you have deleted any images or video clips. It allows you to restore the last deletion. This option is available until another picture or video clip is taken, another deletion occurs, or the camera is turned off or connected to your computer. This does not work if you used the **Format Memory** option to delete images.



**NOTE** Periodic formatting of the internal memory or memory card will keep it clean of file remnants that may cause the camera to lock up, save images slowly, or corrupt images.



## Recording and deleting audio clips

**NOTE** This option works only with still images, not video clips.

After taking a picture, you can go back later and add an audio clip to it. If an image already contains an audio clip, you can record a new clip or delete the current audio clip.

- 1 In **Playback** mode, select the image you want, then press **OK** to display the **Playback** menu.
- 2 Select the  **Record Audio** option.
- 3 If the image does not already have an audio clip, recording starts immediately. Recording continues until you press **OK** again or the memory fills up (whichever comes first). A microphone icon () and an elapsed time counter appear in the Image Display during recording.



If the current image already has an audio clip, the  **Record Audio** menu option will take you to a sub-menu that allows you to keep the current audio clip, record a new clip, or delete the current clip.



**NOTE** To listen to audio clips, you must download the images from the camera to your computer, then use the HP Photo & Imaging software. You can also display images from the camera to a TV as a slideshow. See **Chapter 5: Unloading, printing, and displaying images** on page 51.

## Magnifying images

**NOTE** This option works only with still images, not video clips.

You can use **Magnify** to see a close-up of the image that is being shown in **Playback** mode. This option does not permanently alter the image in the camera.

- 1 In **Playback** mode, select the image you want, then press **OK** to display the **Playback** menu.
- 2 Use the ▼ button to select the **Magnify** option, then press **OK**. This magnifies the current image to three times its size.
- 3 Scroll up or down in the image by using the ▲ ▼ buttons.
- 4 To scroll left and right, press **OK** to display the **Magnify** menu. Highlight the menu option called **Scroll Left/Right**, then press **OK**. Now you can use the ▲ ▼ buttons to scroll left and right in the image.
- 5 To magnify the image to six times its size, press **OK** to display the **Magnify** menu, then select ⚙ **Magnify More**.
- 6 To return to **Playback** mode, press **OK** to display the **Magnify** menu again, then select the ↶ **Exit Magnify** option, or press the **Playback** ▶ button.



## Setup

Selecting this **Playback** menu option displays the **Setup** menu. For information about the **Setup** menu, see **Chapter 6: Using the setup menu** on page 57.





# Chapter 4:

## Using hp instant share

This camera has an exciting feature called **HP Instant Share**. This feature lets you select images in the camera to be automatically sent to a variety of destinations the next time you connect the camera to your computer or to certain HP printers.

For example, right from the back of the camera you can select images that you want to have printed, then connect the camera to the computer or printer, and the selected images will be printed automatically.

As another example, you can select images in the camera to be automatically sent to e-mail addresses (including group lists), online albums, and other destinations the next time you connect the camera to your computer.





When you press the **HP Instant Share (Share)** /  button on the camera, the most recently taken or viewed image appears on the Image Display, along with any print or other destinations that have been selected for the image. You can use the   buttons to scroll through the images to see destinations for the other images in the camera.

Visit [www.hp.com/go/instantshare](http://www.hp.com/go/instantshare) to see **HP Instant Share** in action.



# Using the share menu

Pressing the **Share**  button causes the **Share** menu to appear in the Image Display. The following table describes each of the **Share** menu options.







#	Icon	Description
1		<b>Print 1 Copy</b> of current image when connected to a computer or printer. By default, the picture is printed 10 by 15 cm (4 by 6 inches).
2		<b>Print 2 Copies</b> of current image when connected to a computer or printer.
3		<b>Customize this Menu...</b> lets you add e-mail addresses and other destinations to the <b>Share</b> menu. See <b>Adding destinations to the share menu on the camera</b> on page 46.
4		Check mark indicates the destination has been selected for the currently displayed image. (You can select more than one destination per image.)



## Using hp instant share to print photos

- 1 Press the **Playback**  button to display the images in your camera, then use the   buttons to scroll to an image you want to print.

**NOTE** You cannot select video clips for printing.

- 2 Press the **Share** /  button to activate the **Share** menu, and then use the   buttons to scroll to the print option you want.
- 3 Press **OK** to select the print option, and a  appears over that print option. To un-select a print option, simply press **OK** again.

**NOTE** You can select both the **Print 1 Copy** and the **Print 2 Copies** print options for an image so that 3 copies of the image will be printed when connected to a computer or printer.

- 4 To select another image for printing, go back to step 1. When you are finished selecting all the images you want to print, simply press the **Playback**  button or select  **EXIT SHARE MENU**.
- 5 The next time you connect the camera to your computer or a compatible printer, the images you selected will be automatically printed. See **Chapter 5: Unloading, printing, and displaying images** on page 51 for information about connecting the camera to a computer or printer.

**NOTE** The **Share** menu creates a standard Digital Print Order Format (DPOF) file for print options.



## Using hp instant share to send images to destinations

Using HP Instant Share to send images in your camera to various destinations involves three steps:

- 1 Adding destinations (e-mail addresses, online albums, etc.) to the camera's **Share** menu (using your computer and the camera together).
- 2 Selecting **HP Instant Share** destinations for images (using the **Share** menu on the camera).
- 3 Connecting the camera to your computer to send the images you selected. Your computer must have access to the Internet to complete this step.

### Adding destinations to the share menu on the camera

**NOTE** You will need an Internet connection to complete this procedure on a Windows computer.

- 1 Turn on the camera, and then press the **Share**  button.
- 2 Highlight the **Customize this Menu...**  option and press the **OK** button. A message on the Image Display appears asking you to connect the camera to your computer.

**NOTE** If your computer is running Windows XP, when you connect the camera to your computer in the next step, a dialog box may display that requests you to **Select the program to launch for this action**. Simply click on **Cancel** to close this dialog box.

- 3 Connect the camera to your computer by using the USB cable or the optional HP 8886 camera dock. This activates the Camera Share Menu Setup Wizard.

- 4 From the first window of the Wizard on the computer, click on **Retrieve from Camera**.
- 5 In the screen called **Modify Share Menu**:
  - On Macintosh, click on the **Add...** button.
  - On Windows, check to see that **HP Instant Share E-mail** is visible above the **Add...** button, then click on the **Add...** button.
- 6 If you are using a:
  - Macintosh computer, add the e-mail addresses you want. Then skip to step 8.
  - Windows computer, you will be asked to sign in to HP's Passport program. HP Passport allows you to create a secure account for the photos you share using **HP Instant Share** services. The first time you see this screen, you will need to register as a new user. Follow the instructions on the screen to register.
- 7 Once you have successfully registered, sign in to HP Passport, and then the **HP Instant Share E-mail Setup** screen will appear. Here, you can either enter individual e-mail addresses or create group distribution lists, and specify how you want them to appear in the camera's **Share** menu. You can also enter a subject and message to go with all e-mails that will be sent to each e-mail address or distribution list. After completing the form, click **Next**. In the confirmation screen that appears, click **Finish**.

- 8 The names you specified for your newly added e-mail destinations or group distribution lists should now appear in the **Modify Share Menu** screen (in the **Current Share Menu** section). To add additional e-mail addresses or distribution lists to the camera **Share** menu, repeat steps 5-7 on Windows, or steps 5-6 on Macintosh. If you are using a Windows computer, you will not need to sign in to HP Passport again.











**NOTE** You can have a maximum of 32 **Share** destinations (such as individual e-mail addresses or group distribution lists) in the **Share** menu on your camera in addition to **Print 1 Copy** and **Print 2 Copies**.

- 9 When you have finished adding **Share** destinations, click on either **Save to Camera** on a Windows computer or **Next** on a Macintosh computer to add the new addresses or distribution lists to the camera's **Share** menu. When the computer confirms that the destinations were saved to your camera, disconnect the camera from the computer, and press the **Share**  button to view the new destinations in the **Share** menu.
- 10 You are now ready to select images on the camera to be e-mailed. See the next section for how to do this.



## Selecting hp instant share destinations for images

You can select any number of **HP Instant Share** destinations for each still image in your camera. For example, you can select a specific image to go to 10 e-mail destinations (including group lists), and an online album. However, you cannot select **HP Instant Share** destinations for video clips.

- 1 Press the **Playback**  button to display the images in your camera, then use the   buttons to scroll to an image you want.
- 2 Press the **Share** /  button to activate the **Share** menu, and then use the   buttons to scroll to the **HP Instant Share** destination that you want to select.
- 3 Press **OK** to select the destination, and a  appears next to that destination. (You can select more than one destination or print option for an image.) To un-select a destination, simply press **OK** again.
- 4 To select one or more destinations for another image, go back to step 1. When you are finished selecting **HP Instant Share** destinations, press the **Playback**  button or select  **EXIT SHARE MENU**.
- 5 The next time you connect the camera to your computer, the images you selected will be sent to their respective **HP Instant Share** destinations. See **Chapter 5: Unloading, printing, and displaying images** on page 51 for information about connecting the camera to a computer.

## How hp instant share e-mails images

The way images are e-mailed via HP Instant Share works differently on Windows and Macintosh computers.

<b>Windows</b>	Images are not e-mailed as attachments. Rather, a message is sent to each e-mail address that you selected in the <b>Share</b> menu. The message contains thumbnail images of the pictures you selected for that address, as well as a link to a web page where the recipient can view the images. From that web page, the recipient can do things like reply to you, print the images, save images to their computer, forward images, and more. This makes it easy for people who use different e-mail programs to be able to see your images without the difficulty of dealing with e-mail attachments.
<b>Macintosh</b>	Images are e-mailed directly to recipients using the default e-mail program on your computer.

# Chapter 5: Unloading, printing, and displaying images

Once you have taken pictures, you can unload them from your camera to a computer, print them directly to a printer, or display them on a television.

## Unloading to a computer

**NOTE** If you are using the HP 8886 camera dock to do this task, see the *HP 8886 Camera Dock User's Manual*.

**NOTE** If you are using a Macintosh computer, you must first change the **USB** configuration setting to **Disk Drive** in the **Setup** menu. See **USB configuration** on page 59.

- 1 Your camera came with a special USB cable for connecting the camera to a computer. Connect the larger end of that USB cable to the computer.
- 2 Open the rubber door on the side of the camera and connect the small end of the USB cable to the USB connector on the camera.

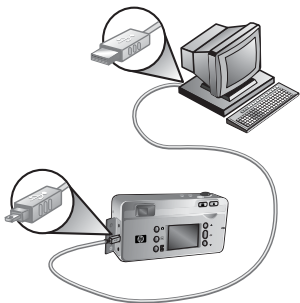

**NOTE** If your computer is running Windows XP, when you turn on the camera in the next step, a dialog box may appear that requests you to **Select the program to launch for this action**. Simply click on **Cancel** to close this dialog box.

- 3 Turn on the camera. The HP Image Unload software will launch on your computer. If you have set the software to automatically unload the images in the camera, the images will automatically unload to the computer. Otherwise, in the **Welcome** screen, click **Start Unload**. If there were any images in the camera that were selected in the **Share** menu for printing or e-mail, those actions are started after the images have been unloaded to the computer.
- 4 When the unload screen on the computer says **Finished**, your images have been saved and shared. You can now disconnect the camera from the computer.

**NOTE** To unload images to a computer that does not have the HP Photo & Imaging software installed on it, change the **USB Configuration** setting to **Disk Drive** in the **Setup** menu. See **USB configuration** on page 59. This allows the camera to appear as another disk drive on the computer so that you can easily copy the image files from the camera to the hard drive of your computer.

**NOTE** If you used a memory card in your camera, another way to unload images from the card to a computer is to use a memory card reader or one of the memory card slots available in HP Photosmart printers. See the manual for your HP Photosmart printer for instructions on how to do this.

# Printing images

**NOTE** If you are using the HP 8886 camera dock to do this task, see the **HP 8886 Camera Dock User's Manual**.

To print images that have been unloaded to the computer, you can use the HP Photo & Imaging software that was shipped with the camera.

You can also connect the camera directly to any HP Photosmart printer or to any other HP printer with front panel USB ports, then print images selected from the camera **Share** menu or all images in the camera.

To print directly to an HP Photosmart printer or to any other HP printer with front panel USB ports:

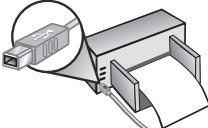
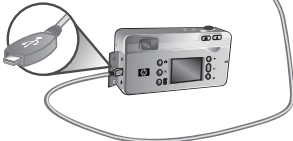
- 1 Turn on the camera.
- 2 Check that the printer is turned on and is online. (There should be no blinking lights on the printer or error messages displayed about the printer.) Load paper into the printer, if needed.
- 3 Your camera came with a special USB cable for connecting the camera directly to a printer. Connect the square end of the USB cable to the printer.
- 4 Open the rubber door on the side of the camera and connect the small end of the USB cable to the USB connector on the camera.

The **Print Setup** menu displays on the camera. If you already selected images to print from the camera **Share** menu, the number of images selected will be shown, as in this example. Otherwise, **Images: ALL** will be displayed.

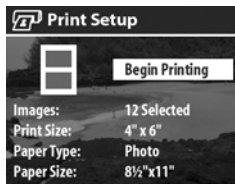

- 5 Adjust the settings in the **Print Setup** menu by using the ▲ ▼ buttons to highlight a menu option and the **OK** button to change the setting for each option.

**NOTE** There is a print preview in the **Print Setup** screen showing the page layout that will be used for printing images. This print preview updates as you change the settings for the **Print Size** and **Paper Size**.

- 6 Press the **OK** button to begin printing.

**NOTE** If you used a memory card in your camera, another way to print images directly from the card is to insert the card into the appropriate memory card slot available in HP Photosmart printers. See the manual for your HP Photosmart printer for instructions on how to do this.

# Displaying images on a TV

Images in your camera can easily be displayed as a slideshow on almost any TV (television).

**NOTE** If you are using the HP 8886 camera dock to do this task, see the **HP 8886 Camera Dock User's Manual**.

- 1** To connect the camera directly to a TV, you need an A/V (Audio/Video) cable. The A/V cable is included in the HP 8886 camera dock kit, or may be purchased separately (see **Purchasing camera accessories** on page 93).
- 2** Your camera will send either an NTSC or PAL video signal to a TV. The NTSC format is used primarily in North America and Japan, while the PAL format is used primarily in Europe. This setting is done for you when you set the language of the camera. If you want to change the video signal format, change the **TV Configuration** setting in the **Setup** menu. See **TV configuration** on page 60.
- 3** Your camera will be the source for the TV signal (just like a VCR or a camcorder), so you must set the TV to take video input from an external video source (your camera) instead of the antenna or cable TV. Refer to the TV user's manual for directions on how to do this.
- 4** Turn on the camera, then connect the A/V cable to the A/V inputs on the TV and to the TV connector on your camera.

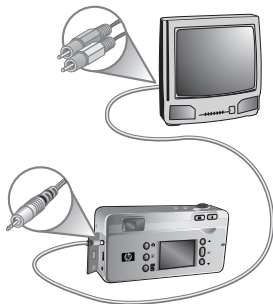

The camera starts a slideshow of each image, playing any attached audio clip or video clip, and then fading to the next image. You can also manually scroll through the images by pressing the ▲ ▼ buttons.

**NOTE** The Image Display on the camera turns off when the camera is connected to a TV. However, you can still use the **Playback** and **Share** menus while connected to the TV, since the menus will display on the TV screen.



# Chapter 6: Using the setup menu

- 1 To display the **Setup** menu, open either the **Playback** or **Capture** menu and use the ▲ ▼ buttons to highlight the **Setup** menu option. Then press the OK button. (For information about these other menus, see **Using the playback menu** on page 37 and **Advanced capture settings** on page 29.)

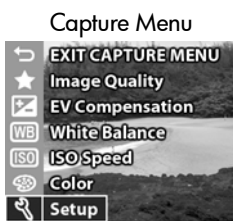

- 2 Use the ▲ ▼ buttons to scroll through the **Setup** menu options.
- 3 Press the OK button to select a highlighted option and display its sub-menu.
- 4 Within a sub-menu, use the ▲ ▼ buttons and the OK button to change the setting for the **Setup** menu option.
- 5 To exit the **Setup** menu, highlight the EXIT SETUP MENU option and press the OK button.



## Camera sounds

This **Setup** menu option allows you to turn camera sounds on or off.

Camera sounds are the sounds that the camera makes when you turn it on, press a button, or take a picture. Camera sounds are not the audio sounds recorded with images or video clips.

The default setting is **On**.

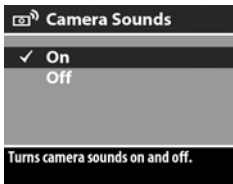

## Date & time

This **Setup** menu option allows you to set the current date and time, as well as the date/time format, for the camera. This is usually done when you first set up the camera, but you may need to re-set the date and time when you are travelling to different time zones, or if the date or time is incorrect.



To set the date, time, and date/time format, follow the same procedure used in **Setting the date and time** on page 17.

# USB configuration

This **Setup** menu option determines how the camera appears when connected to a computer.

- **Digital Camera**—Causes the computer to recognize the camera as a digital camera using the Picture Transfer Protocol (PTP) standard. This is the default setting on the camera.
- **Disk Drive**—Causes the computer to recognize the camera as a disk drive using the Mass Storage Device Class (MSDC) standard.

Use this table as a guide for which USB Configuration setting to use with your computer:

HP Photo & Imaging software:	Windows	Macintosh
Installed	<b>Digital Camera</b>	<b>Disk Drive</b>
Not installed	<b>Disk Drive</b>	<b>Digital Camera (OSX systems)</b>



# TV configuration

This **Setup** menu option sets the format of the video signal for displaying camera images on a television (TV) that is connected to the camera with an optional Audio/Video cable or HP 8886 camera dock.



- **NTSC**—format used primarily in North America and Japan
- **PAL**—format used primarily in Europe

The default setting depends on the language that you selected when you powered on the camera for the first time.

For more information on connecting the camera to a TV, see either **Displaying images on a TV** on page 55 when using an optional Audio/Video cable, or the **HP 8886 Camera Dock User's Manual** when using the camera dock.

# Language

This **Setup** menu option sets the language of the camera interface, including the text in menus and on the Image Display. The default setting is **English**.

To set the language on the camera, follow the same procedure used in **Choosing the language** on page 16.



## Move images to card

This option lets you move images from the camera's internal memory to a memory card. It appears in the **Setup** menu only if a memory card is installed and internal memory contains at least one image.

If there is room to move all the internal files to the memory card, then this confirmation screen appears. If you select **Yes** to move images, they are moved to the card, and all moved images are deleted from internal memory.



If only some of the images will fit on the memory card, this screen appears which allows you to move as many images as the card will hold. The moved images will be deleted from internal memory, and the images that could not be moved will be retained in internal memory.



**NOTE** When a memory card is inserted, only the images on the card can be viewed on the Image Display. To view the images stored in internal memory, remove the memory card.



# Chapter 7: Troubleshooting and support

## Problems and solutions

**NOTE** If you still cannot solve your problem after reviewing the troubleshooting information provided in the following table, you can run diagnostic tests on your camera to try to isolate and solve the problem yourself. The diagnostic tests for this digital camera are provided on the following website:

[www.hp.com/support](http://www.hp.com/support)

Problem	Possible cause	Solution
The camera does not turn on.	The batteries are functioning incorrectly, are dead, are installed incorrectly, or are missing.	The charge in the batteries can be low or completely drained. Try installing new or recharged batteries.  Ensure that the batteries are inserted correctly.  Do not use ordinary alkaline batteries. For best results, use photo-lithium batteries or rechargeable NiMH batteries. If you must use alkaline batteries, use high-grade "ultra" or "premium" varieties.

Problem	Possible cause	Solution
<p>The camera does not turn on. (continued)</p>	<p>The HP AC adapter is not correctly connected to the camera, or is not plugged into a power outlet.</p>	<p>Ensure that the HP AC power adapter is:</p> <ul style="list-style-type: none"> <li>● connected to the power adapter connector of the camera (see page 11)</li> <li>● plugged into a working electrical outlet.</li> </ul>
	<p>The HP AC power adapter is not functioning correctly.</p>	<p>Ensure that the HP AC adapter is not damaged or defective and is plugged into a working electrical outlet.</p>
	<p>The memory card is defective or contains corrupt images.</p>	<p>Remove the memory card.</p>
<p>I replace the camera batteries frequently.</p>	<p>The NiMH batteries you are using were recharged incorrectly, or have drained on their own because they have not been used lately.</p>	<p>When NiMH batteries are brand new or have drained from lack of use, they should be charged and fully drained 3-4 times to reach optimum capacity. Also, NiMH batteries discharge on their own when not in use and when not installed in the camera. So if you have not used them in a week or more, they may benefit from being charged.</p>



Problem	Possible cause	Solution
I replace the camera batteries frequently. (continued)	Extended Image Display use for Live View or video recording and excessive flash use consume a lot of battery power.	Minimize the use of <b>Live View</b> and video, especially if using ordinary alkaline batteries. Also use the flash and zoom only when necessary.
		Use an HP AC power adapter to power the camera when you are using the Image Display for an extended period of time, or use the viewfinder instead of the Image Display whenever possible.
The camera batteries will not charge.	Rechargeable batteries are not inserted.	Install NiMH batteries. Lithium and alkaline batteries cannot be recharged.
	Batteries are already charged.	Battery charging will not start if the batteries were recently charged. Try charging them again after they have drained awhile.

Problem	Possible cause	Solution
The camera batteries will not charge. (continued)	Battery voltage is too low for charging to start.	The camera will not attempt to charge batteries that may be damaged or over-discharged. Remove the batteries from the camera and charge them in an external battery charger, then try them in the camera again. If this does not work, it is likely that one or more of the batteries are bad. Purchase new NiMH batteries and try again.
	The wrong AC power adapter is being used.	Use only the HP AC power adapter approved for use with this camera. See <b>Purchasing camera accessories</b> on page 93.
	The batteries are damaged or bad.	NiMH batteries degrade over time and can fail. If the camera detects a problem with the batteries, it will not start charging or will stop charging prematurely. Purchase new batteries.
The Memory/USB light blinks as if the batteries are being recharged, but there are no batteries installed.	The camera does not recognize that there are no batteries installed.	Do nothing. The blinking is harmless and should stop after 5-30 minutes.

Problem	Possible cause	Solution
The wrong date and/or time is shown.	The batteries died or were removed from the camera for too long.	The date and time will be maintained for about 10 minutes without batteries installed. Reset the date and time by using the <b>Date &amp; Time</b> option in the <b>Setup</b> menu. (See page 58)
The camera does not respond when I press a button.	The camera is turned off or has shut down.	Turn on the camera, or turn it off and then on again.
	The camera is connected to a computer.	Most of the camera buttons, except for the lens cover/power switch, do not respond when the camera is connected to a computer. If they respond, it is only to turn the Image Display on if it is off, or, in some cases, turn the Image Display off if it is on.
	The batteries are drained.	Replace or recharge the batteries.
	Images in the memory card may be corrupted.	Remove the memory card.
	The camera has stopped operating.	Open the battery/memory card door and then close it. This should reset the camera.

Problem	Possible cause	Solution
A long delay occurs between pressing the Shutter button and the camera taking a picture.	The camera is taking a long exposure.	Use a tripod or the flash.
	The camera is set to Red-eye Reduction.	It will take longer to take a picture with Red-eye Reduction set to On. The shutter is delayed because of the additional flash. In turn, make sure your subjects wait for the second flash.
The camera does not take a picture when I press the Shutter button.	You did not press the Shutter button hard enough.	Press the Shutter button all the way down.
	The memory storage is full (either internal or card).	Unload images from the camera to your computer, then delete all images from internal memory or the memory card. Move images from internal memory to a memory card to free up internal memory, or replace the card with a new one.
	The memory card is locked.	Switch the locking tab on the memory card to the unlocked position.
	The flash is recharging.	Wait until the flash has recharged before taking another picture.

Problem	Possible cause	Solution
<b>The camera does not take a picture when I press the Shutter button.</b> (continued)	The camera is still saving the last picture you took.	Wait a few seconds for the camera to finish processing the image, and then press the <b>Shutter</b> button.
	Images in the memory (internal or card) may be corrupted.	Format the memory. (See page 40)
<b>My image is blurry.</b>	Your subject was too close to the camera lens.	Do not try to get closer than the camera's minimum focus range (See <b>Appendix B: Specifications</b> on page 95)
	You moved the camera while you took the picture.	Hold the camera steady as you press the <b>Shutter</b> button or use a tripod.
	The light is low and the flash is set to <b>Flash Off</b> .	In dim light, the camera requires a longer exposure. Use a tripod to hold the camera steady, improve lighting conditions, or set the flash to <b>Flash On</b> (see page 25).

Problem	Possible cause	Solution
My image is too bright.	The flash provided too much light.	Use the <b>Flash Off</b> setting (see page 25).
	You were too close to the subject to use the flash.	Move back from the subject or set the flash to <b>Flash Off</b> and take the picture again.
	A natural or artificial source other than the flash provided too much light.	Try taking the picture from a different angle. Avoid pointing the camera directly toward a bright light or reflective surface on a sunny day. Use the <b>Flash On</b> setting (see page 25) or adjust the <b>Exposure Compensation</b> (see page 31).
	The scene had many dark objects, such as a black dog on a black couch.	Decrease the <b>Exposure Compensation</b> (see page 31) so the dark objects in the scene will not look “washed-out”.

Problem	Possible cause	Solution
My image is too dark.	There was not enough light.	Wait for natural lighting conditions to improve, add indirect lighting, or adjust the <b>Exposure Compensation</b> (see page 31).
	The flash was on, but the subject was too far away.	Make sure your subject is within the flash working distance (see <b>Appendix B: Specifications</b> on page 95) or try turning flash off (will require a longer exposure).
	A light shone behind the subject.	Use the <b>Flash On</b> setting (see page 25) to brighten the subject. Or adjust the <b>Exposure Compensation</b> (see page 25).
	Your finger blocked the flash or the sensor next to the video/self-timer light.	Be sure to move your fingers away from the flash and the sensor when you take a picture.
	The scene had many light-colored objects, such as a white dog in snow.	Increase the <b>Exposure Compensation</b> (see page 31) so the light-colored objects in the scene will not look “muddy.”

# Error messages on the camera

Message	Possible cause	Solution
<b>BATTERIES DEPLETED</b> Camera is shutting down	Battery power is too low to continue operation.	Replace or recharge batteries, or use an optional HP AC adapter.
<b>Batteries are too low for Live View</b>	Battery power is too low to use <b>Live View</b> on the Image Display.	Take pictures with the optical viewfinder instead of the Image Display. Replace or recharge batteries, or use an optional HP AC adapter.
<b>Batteries are too low to record a video clip</b>	Battery power is too low and the camera will shut down soon.	Either recharge or replace the batteries.
<b>Batteries cannot be charged</b>	Either an error occurred during charging, an AC power disruption occurred during charging, the wrong AC power adapter is being used, batteries are defective, or no batteries are installed in the camera.	Retry charging the batteries a couple of times. If that fails, purchase new batteries and try again.



Message	Possible cause	Solution
<b>Unsupported card</b>	The card in the memory slot is not a memory card or is not a supported memory card.	Ensure that the memory card is the proper type for your camera. (See <b>Storage</b> on page 95.)
<b>Card is wrong format</b>	The card is an unsupported format, such as FAT32.	Press <b>OK</b> (this should display the <b>Format Card</b> screen) or format the memory card by using the <b>Format Card</b> option in the <b>Delete</b> menu. This will delete all data on the card.
<b>The card requires formatting</b>	The memory card needs to be formatted.	Press <b>OK</b> (this should display the <b>Format Card</b> screen) or format the memory card by using the <b>Format Card</b> option in the <b>Delete</b> menu. This will delete all data on the card.
<b>Card is unreadable</b>	The memory card is not a supported card or the card is corrupted.	Ensure that the memory card is the proper type for your camera. (See <b>Storage</b> on page 95.) If it is the proper type, it is probably corrupted. Replace the memory card.
<b>The card is locked</b>	The locking tab on the side of the memory card is in the locked position.	Switch the locking tab to the unlocked position or insert a new card.

Message	Possible cause	Solution
<b>Insufficient memory on the card</b>	Not enough room to copy any files from internal memory to the card.	Unload images from the camera to your computer, then delete all images on the memory card. Or replace the card with a new one.
<b>Error saving video</b>	Memory card was removed before the camera was finished writing to the card.	Always wait until the <b>Memory/USB</b> light stops blinking before removing the card from the camera.
<b>1st screen:</b> No card in camera <b>2nd screen:</b> Error saving image	Memory card was removed before the camera was finished writing to the card.	Reinsert the memory card. Always wait until the <b>Memory/USB</b> light stops blinking before removing the card from the camera. If the card is removed while writing to it, the image is lost.
<b>Invalid date</b>	An attempt was made to enter an invalid date (such as 2/31/2003).	Press <b>OK</b> to clear the message, and then enter a valid date.
<b>Unsupported image file</b>	You tried to magnify, rotate, or print an image that was taken with another camera.	Press <b>OK</b> to clear the message. You cannot do those operations on files that were not created by your camera.

Message	Possible cause	Solution
<b>Insufficient space in memory (on card) to complete request.</b>	Insufficient room in internal memory or on the memory card to rotate an image.	Free up space on the card by deleting some images, or perform the rotation using computer software.
<b>Communication error</b>	Camera received an error code from the HP software on the computer.	Disconnect the USB cable (or lift the camera out of the HP camera dock), then re-connect and try again.
<b>Charging Flash...</b>	The camera is recharging the flash.	It takes longer to charge the flash when the batteries are low. If you see this message often, you may need to replace or recharge the batteries.
<b>Card full or Memory full</b>	Insufficient room in internal memory or on the memory card to save more images.	Unload images from the camera to your computer, then delete all images from the memory card or internal memory. Or put a new memory card in the camera.
<b>No images in memory or No images on card</b>	There are no images or video clips in the camera and you are trying to review them.	Take some pictures or video clips.

Message	Possible cause	Solution
<b>Cannot display image</b>	Possibly comes from copying images to the memory card from a computer, or a corrupted image caused by the camera not shutting down properly.	Unload the images to your computer, and then use the HP Photo & Imaging software to view the images. Also, do not remove batteries or the memory card when the camera is turned on.
<b>Selected print size is larger than selected paper size</b>	Print size is larger than paper size in the Print Setup menu.	Press <b>OK</b> to clear the message, then change either print size or paper size in the Print Setup menu.
<b>Unknown USB device</b>	The camera is connected to a USB device that it does not recognize.	Make sure that the camera is connected to a supported printer or computer.
<b>Unsupported printer</b>	The printer is an unsupported device.	Connect the camera to a supported printer, such as an HP Photosmart printer or another HP printer with front panel USB ports. Or connect the camera to a computer and print from there instead.

Message	Possible cause	Solution
Unable to communicate with printer	There is no connection between the camera and printer.	Make sure the cable is connected between the camera or HP 8886 camera dock and the printer. If that does not work, turn off the camera and disconnect it. Turn the printer off and then on again. Re-connect the camera and turn it on.
	A supported printer is either turned off or not connected to the camera.	Make sure the camera is connected to a supported printer and that the printer is turned on.
Disengage photo tray	The selected paper size cannot be used with the printer photo tray.	Disengage the printer photo tray, or change the paper size.
Printer top cover is open	The printer is open.	Close the top cover of the printer.
Incorrect or missing print cartridge	The printer cartridge is the incorrect model or is missing.	Install a new printer cartridge, turn the printer off, then turn it back on.
Printer has a paper jam	There is a paper jam.	Turn off the printer. Clear the paper jam, and then turn on the printer.
Printer is out of paper	Your printer is out of paper.	Load paper into the printer, and then press <b>OK</b> or <b>Continue</b> on the printer.

Message	Possible cause	Solution
Printing canceled	The print job has been canceled.	Press the <b>OK</b> button on the camera. Complete the print request again.
Any error code numbers that appear	The camera may have a hardware or firmware problem.	Turn the camera off and then on again. If the problem persists, call HP Support (see page 81).

## Error messages on the computer

Message	Possible cause	Solution
Connection between the imaging device and computer failed	The camera might be connected to a computer through a USB hub.	Try connecting the camera directly to the computer, or disconnect other devices attached to the USB hub.
The software cannot retrieve the Share Menu information from your camera	The computer needs to write files to memory during HP Instant Share setup, but the memory is either full, or the memory card is locked.	Make room on the internal memory or memory card. If you are using an SD memory card, unlock it by switching the locking tab on the card to the unlocked position.
Computer cannot find the connected camera	The camera is turned off.	Turn on the camera.
	The camera is not working correctly.	Try connecting the camera directly to an HP Photosmart printer or an HP printer with front panel USB ports, and print an image. This will verify that the image, memory card, USB connection, and the USB cable are functioning correctly, or not.
	The cable is not connected correctly.	Make sure that the cable is firmly connected to the computer and camera.

Message	Possible cause	Solution
Computer cannot find the connected camera (continued)	The camera is set to the <b>Digital Camera</b> setting in the <b>USB Configuration</b> sub-menu of the <b>Setup</b> menu. But the computer cannot recognize the camera as a digital camera.	Change the <b>USB Configuration</b> setting to <b>Disk Drive</b> in the <b>Setup</b> menu. (See <b>USB configuration</b> on page 59.) This allows the camera to appear as another disk drive on the computer so that you can easily copy the image files from the camera to the hard drive of your computer.
	The camera is connected to the computer through a USB hub, and your USB hub is not compatible with the camera.	Connect the camera directly to a USB port on the computer.
	You are using the HP 8886 camera dock and forgot to press the <b>Save/Print</b> button.	Press the <b>Save/Print</b>  button on the dock.
	The memory card is locked. (SD cards only)	Switch the locking tab on the memory card to the unlocked position.
	The USB connection failed.	Reboot the computer.



## Getting assistance

This section contains support information for your digital camera, including support website information, an explanation of the support process, and support phone numbers.

### HP accessibility website

Customers with disabilities can get help by visiting [www.hp.com/hpinfo/community/accessibility/prodserv](http://www.hp.com/hpinfo/community/accessibility/prodserv).

### HP photosmart website

Visit [www.photosmart.hp.com](http://www.photosmart.hp.com) or [www.hp.com/photosmart](http://www.hp.com/photosmart) for the following information:

- Tips on using your camera more effectively and creatively
- HP digital camera driver updates and software
- Register your product
- Subscribe to newsletters, driver and software updates, and support alerts

### Support process

The HP support process works most effectively if you perform the following steps in the order specified:

- 1 Review the troubleshooting section of this User's Manual, which starts on page 63.
- 2 Access the HP Consumer Support Website for support. If you have access to the Internet, you can obtain a wide range of information about your digital camera. Visit the HP website for product help, drivers, and software updates at [www.hp.com/support](http://www.hp.com/support).

Support is available in the following languages: Dutch, English, French, German, Italian, Portuguese, Spanish, Swedish, Traditional Chinese, Simplified Chinese, Japanese, Korean. (Danish, Finnish, and Norwegian support information is available in English only.)

- 3** Access HP e-support. If you have access to the Internet, connect with HP via e-mail by going to: [www.hp.com/support](http://www.hp.com/support). You will receive a personal reply from an HP Consumer Support technician. E-mail support is available in the languages listed at that website.
- 4** Contact your local HP dealer. If your digital camera has a hardware failure, take it to your local HP dealer for a solution. Service is free during your digital camera's limited warranty period.
- 5** Contact HP Consumer Support for support by phone. Please consult the following website to check the details and conditions of phone support in your country/region: [www.hp.com/support](http://www.hp.com/support). As a part of HP's continuing efforts to improve phone support information services, we advise you to check the HP website on a regular basis for new information regarding service features and delivery. If you cannot solve the problem using the above options, call HP while you are in front of your computer and digital camera. For faster service, please be prepared to provide the following information:
  - The digital camera's model number (located on the front of the camera)
  - The digital camera's serial number (located on the bottom of the camera)
  - The computer's operating system
  - The version of the digital camera software (located on the camera's CD label)

- Messages displayed at the time the situation occurred

The applicable conditions for HP phone support are subject to change without notice.

Telephone support is free from the date of purchase for the period specified unless otherwise noted.

Location	Free Phone Support Period
Africa	30 days
Asia Pacific	1 year
Canada	1 year
Europe	1 year
Latin America	1 year
Middle East	30 days
United States	90 days

## Phone support in the United States

Support is available both during and after the warranty period.

Within the period of your warranty, telephone support is provided free of charge. Call (208) 323-2551. If this is a long distance call for you, long distance charges will apply. US phone support is available in both English and Spanish 24 hours a day, 7 days a week (days and hours of support may change without notice).

After the warranty period, call (208) 323-2551. Charges are \$25.00 per issue, and are charged to your credit card. If you think your HP product needs service, call HP Consumer Support, which can help determine if service is required.

## Phone support in Europe, the Middle East, and Africa

HP Consumer Support phone numbers and policies may change. Visit the following website to check the details and conditions of phone support in your country/region:  
[www.hp.com/support](http://www.hp.com/support).

**Algeria** +213 (0)61 56 45 43

**Austria** +43 (0)820 87 4417

**Bahrain** +973 800 728

**Belgium** 070 300 005 (Dutch)  
070 300 004 (French)

**Czech Republic** +42 (0) 2 6130 7310

**Denmark** +45 70202845

**Egypt** +20 02 532 5222

**Finland** +358 (0)203 66 767

**France** +33 (0) 892 6960 22 (Euro 0.34/min)

**Germany** +49 (0)180 5652 180 (Euro 0.12/min)

**Greece** +30 10 60 73 603

**Hungary** +36 (0) 1 382 1111

**Ireland** 1890 923902

**Israel** +972 (0) 9 830 4848

**Italy** 848 800 871

**Luxembourg** 900 40 006 (French)  
900 40 007 (German)

**Morocco** +212 224 04747

**Netherlands** 0900 2020 165 (Euro 0.10/minute)

**Norway** +47 815 62 070

**Poland** +48 22 865 98 00

**Portugal** 808 201 492

**Romania** +40 1 315 44 42

**Russian Federation** +7 095 797 3520 (Moscow)  
+7 812 346 7997 (St Petersburg)

**Saudi Arabia** +966 800 897 14440

**Slovakia** +421 2 6820 8080

**South Africa** 086 000 1030 (inside RSA)  
+27-11 258 9301 (outside RSA)

**Spain** 902 010 059

**Sweden** +46 (0) 77 120 4765

**Switzerland** 0848 672 672 (German, French, Italian—  
Peak time 0.08 CHF/Outside peak 0.04 CHF)

**Tunisia** +216 1 891 222

**Turkey** +90 216 579 71 71

**Ukraine** +7 (380 44) 490-3520

**United Arab Emirates** 800 4910

**United Kingdom** +44 (0)870 010 4320

## Other phone support worldwide

HP Consumer Support phone numbers and policies may change. Visit the following website to check the details and conditions of phone support in your country/region:  
[www.hp.com/support](http://www.hp.com/support).

**Argentina** +54 0 810 555 5520

**Australia** +61 (3) 8877 8000 (or local (03) 8877 8000)

**Brazil** +55 (11) 3747 7799 (Grande São Paulo)  
+55 0800 157751 (outside Grande São Paulo)

**Canada** +1 905 206 4663 (during the warranty period)  
+1 877 621 4722 (after the warranty period)

**Central America and the Caribbean** +1 800 711 2884

**Chile** +56 800 22 5547 (Post-sales Business Computing)  
+56 800 360 999 (Post-sales Home Computing)

**China** +86 (21) 3881 4518

**Colombia** +57 9 800 114 726

**Guatemala** +502 1 800 999 5105

**Hong Kong SAR** +852 3002 8555

**India** 1 600 112267 or +91 11 682 6035 (Hindi & English)

**Indonesia** +62 (21) 350 3408

**Japan** 0570 000 511 (inside Japan)  
+81 3 3335 9800 (outside Japan)

**Korea, Republic of** +82 (2) 3270 0700 (Seoul)  
0 80-999-0700 (outside Seoul)

**Malaysia** +60 1 800 805 405

**Mexico** +52 58 9922 (Mexico City)  
+52 01 800 472 6684 (outside Mexico City)

**New Zealand** +64 (9) 356 6640

**Peru** +51 0 800 10111

**Philippines** +63 (2) 867 3551

**Puerto Rico** +1 877 2320 589

**Singapore** +65 6272 5300

**Taiwan** +886 0 800 010055

**Thailand** +66 (2) 661 4000

**United States** +1 (208) 323-2551

**Venezuela** +58 0 800 4746 8368

**Vietnam** +84 (0) 8 823 4530





# Appendix A: Batteries and camera accessories

## Managing batteries





Your camera uses two AA batteries. For best results, use photo-lithium or rechargeable NiMH batteries. If you must use alkaline batteries, use high-grade “ultra” or “premium” varieties instead of ordinary alkaline batteries.

The following table shows how different types of batteries perform in different type of use scenarios:

Type of use	Alkaline	Photo-Lithium	NiMH
Most economical (more than 30 pictures per month)	Poor	Fair	Good
Most economical (less than 30 pictures per month)	Fair	Good	Fair
Heavy use of flash, frequent pictures	Poor	Good	Good
Heavy use of video	Poor	Good	Good
Heavy use of <b>Live View</b>	Poor	Good	Good
Longest overall battery life	Poor	Good	Fair
Low temperature/Winter use	Poor	Good	Fair
Infrequent use (without dock)	Fair	Good	Fair
Infrequent use (with dock)	Fair	Good	Good
Want to recharge batteries	No	No	Good

**NOTE** If you do not intend to use your camera for extended periods of time (more than a month), we strongly recommend that you remove the batteries.

The following battery levels may appear on the Image Display.

Icon	Description
	Batteries have 40-100 percent battery life remaining.
	Batteries have 10-40 percent battery life remaining.
	Batteries have less than 10 percent remaining. Camera will power down soon. <b>Live View</b> is disabled.
	Camera is operating on AC power

You might notice that occasionally the battery level icons will fluctuate with the same set of batteries. This occurs because some operating modes like **Live View** and video recording consume much more power than other modes, and will cause the battery level icons to indicate your batteries are low, because battery operating time in those modes is short. When you switch to a mode that requires less power, like **Playback**, the battery level icon may go back up, indicating there is more time left in the batteries if you stay in that mode.

**NOTE** When you remove the batteries from the camera, the date and time settings are preserved for approximately 10 minutes. If the camera is without batteries for longer than 10 minutes, the clock is set to the last date and time at which the camera was used. You may be prompted to update the date and time.

## Rechargeable batteries

Nickel Metal Hydride (NiMH) batteries can be recharged by using a battery charger. NiMH batteries can also be recharged in the camera when the camera is connected to an optional HP AC adapter or HP 8886 camera dock. Batteries are fully recharged via the optional HP AC adapter or camera dock in 15 hours.

Some things to keep in mind when using NiMH batteries are:

- Always recharge both NiMH batteries at the same time. One low-charged battery will reduce the battery life for both batteries in the camera.
- For NiMH batteries to reach optimal capacity and performance, they should first be discharged completely and recharged four separate times.
- NiMH batteries discharge when not in use, whether they are installed in a device (such as in the camera) or not. If they have not been used for more than two weeks, recharge them before using them again.

## Extending battery life

- Minimize the use of **Live View** and video, especially when using alkaline batteries.
- Use the viewfinder to frame pictures instead of the Image Display. Leave the Image Display off whenever possible.
- Use the **Auto** flash setting rather than **Flash On**.
- Use an optional HP AC adapter or HP 8886 camera dock when the camera will be on for extended periods of time, or when unloading pictures to your computer, printing, or connecting to the TV.

## Power conservation

The camera will conserve battery power by turning off the Image Display automatically if there is no button activity for 60 seconds. If no buttons are pressed for 5 minutes, the camera turns off (unless it is printing or connected to a computer or TV).

# Purchasing camera accessories

You can purchase additional accessories for your camera from your local retailer or online at [www.hpshopping.com](http://www.hpshopping.com). Some accessories for this digital camera are listed below:

- HP Photosmart 8886 camera dock (includes a camera dock, remote control, two rechargeable NiMH batteries, audio/video cable, USB cable, and an AC power adapter):
  - United States and Canada—C8886A #A2L
  - Mexico, Brazil, Chile, Argentina, and Uruguay—C8886A #ABM
  - Korea, Australia, and New Zealand—C8886A #UUF
  - Europe (except for the United Kingdom, see the next option below)—C8886A #AC2
  - United Kingdom and South Africa—C8886A #ABU
- HP Photosmart Digital Camera Deluxe Starter Kit (C8889A for North America, C8884B #UUS for continental Europe, and C8884B #ABU for the United Kingdom).  
Contents include:
  - Padded camera case
  - Battery recharger
  - 4 rechargeable NiMH batteries
  - DC car adapter for battery recharger
  - 32 MB SD memory card
- HP Photosmart Digital Camera Starter Kit (Y1789B, option #A2L for North America, #UUS for continental Europe, and #ABU for the United Kingdom).  
Contents include:
  - Padded camera case
  - Battery recharger
  - 4 rechargeable NiMH batteries

- HP Photosmart 3.3V AC power adapter (HP supports only HP AC power adapters and other accessories expressly approved by HP):
  - United States and Canada—C8912 #A2L
  - Korea, Australia, and New Zealand—C8912 #UUF
  - Europe—C8912 #UUS
- Memory card—Secure digital (SD) or MultiMediaCard™ (MMC). 128 MB is the largest memory card tested by HP. Larger sizes of cards have not been tested, but they should work - use at your own risk. This product only supports the use of MMC memory cards that have been verified compliant to the MultiMediaCard™ specification as of January 2000. Compliant MMC memory cards have the MultiMediaCard™ logo (|||||||**M**) on the card. The following memory cards are available from HP:
  - 32 MB SD card—C8895A
  - 64 MB SD card—C8896A
  - 128 MB SD card—C8897A
- SD to CF card adapter—C8885A (only available in the U.S. on [www.hpshopping.com](http://www.hpshopping.com))
- HP Photosmart padded camera case—C8905A
- HP audio/video accessory cable to connect to a television (TV).

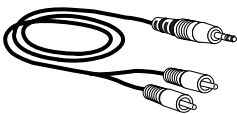

**NOTE** You can also use any Y-adapter audio cable with dual RCA plugs on one end and a 1/8 inch (3.175 mm) mini-stereo jack on the other end. You will also need an adapter plug that accepts a 1/8 inch (3.175 mm) jack and fits into a 3/32 inch (2.38 mm) jack.

# Appendix B: Specifications

Feature	Description
Resolution	Still Pictures: <ul style="list-style-type: none"><li>• 3.27 MP (2096 by 1560) total pixel count</li><li>• 3.14 MP (2048 by 1536) effective pixel count</li></ul> Video clips: <ul style="list-style-type: none"><li>• 1/4 VGA (320 x 240 total pixel count)</li></ul>
Sensor	Diagonal 6.73 mm (1/2.7-inch, 4:3 format) CCD
Color depth	30-bit (10 bits by 3 colors)
Storage	<ul style="list-style-type: none"><li>• 16 MB internal Flash memory</li><li>• Slot for memory card; Secure Digital (SD) or MultiMediaCard™ (MMC) memory card supported (see page 94)</li></ul> Number of images that can be saved in memory (internal or card) depends on the image quality setting (see page 30)
Lens	Fixed focal length: <ul style="list-style-type: none"><li>• 5.67 mm</li><li>• 35 mm equivalent approximately 36 mm)</li></ul> F-Number: f/4.0 and f/8.0
Viewfinder	Optical viewfinder, no diopter adjustment
Zoom	<ul style="list-style-type: none"><li>• 3x digital zoom (HP 433 camera)</li><li>• 5x digital zoom (HP 435 camera)</li></ul>

Feature	Description
<b>Focus</b>	Fixed focus control range of 0.85 m (33.5 in) to infinity
<b>Shutter speed</b>	1/1000 to 4 seconds
<b>Tripod mount</b>	Yes
<b>Built-in flash</b>	1 to 6 second recharge
<b>Flash working distance</b>	2.5 m (9.8 ft), guide number 7
<b>External flash</b>	No
<b>Flash settings</b>	Auto (default), Auto with Red-eye Reduction, Flash On, Night, Flash Off
<b>Image Display</b>	1.5-inch LED backlit, TFT LCD with 61,380 pixels
<b>Image capture modes</b>	<ul style="list-style-type: none"> <li>● Still (default)</li> <li>● Self-Timer— 10 second delay standard (both still and video)</li> <li>● Video— 15 frames per second streaming to memory, maximum length limited only by available memory</li> </ul>
<b>Audio capture</b>	<ul style="list-style-type: none"> <li>● Still pictures—Audio can be captured with each still picture by holding down <b>Shutter</b> button or added later (in the <b>Playback</b> menu), maximum length limited only by available memory</li> <li>● Video—Audio captured automatically with video</li> </ul>
<b>Exposure Mode settings</b>	Auto (default) and Action
<b>Exposure Compensation</b>	Can be set manually from -2.0 to +2.0 EV (Exposure Value) in 0.5 EV increments
<b>White Balance settings</b>	Auto (default), Sun, Shade, Tungsten, Fluorescent



Feature	Description
ISO Speed settings	Auto (default), manually selectable 100, 200, 400
Color settings	Full Color (default) and Black & White
Quality settings	<ul style="list-style-type: none"> <li>★★★ — Best</li> <li>★★ — Better (default)</li> <li>★ — Good</li> </ul>
Remembered and default camera settings	<p><i>Remembered settings (saved when camera is turned off):</i></p> <ul style="list-style-type: none"> <li>● Quality</li> <li>● Language</li> <li>● USB Configuration</li> <li>● TV Configuration</li> <li>● Customized HP Instant Share destinations</li> <li>● Direct print parameters (paper size, paper type, and print size)</li> <li>● Camera sounds</li> </ul> <p><i>Default settings (returned to default when camera is turned off):</i></p> <ul style="list-style-type: none"> <li>● Flash (default = Auto)</li> <li>● Digital zoom (default = Off)</li> <li>● Capture mode (default - None)</li> <li>● EV Compensation (default = 0.0)</li> <li>● White Balance (default = Auto)</li> <li>● ISO (default = Auto)</li> <li>● Color (default = Full Color)</li> </ul>
Contrast	Not adjustable
Playback magnification	Yes, approximately 3x and 6x
Compression format	<ul style="list-style-type: none"> <li>● JPEG (EXIF) for still images</li> <li>● MPEG-1 for video clips</li> </ul>

Feature	Description
<b>Interfaces</b>	<ul style="list-style-type: none"> <li>● USB to a computer or printer (any HP Photosmart printers or any HP printers with front panel USB ports).</li> <li>● Audio/Video out to TV</li> <li>● DC IN 3.3Vdc @ 2500mA</li> <li>● HP 8886 camera dock</li> </ul>
<b>Standards</b>	<ul style="list-style-type: none"> <li>● PTP (15740)</li> <li>● MSDC transfer</li> <li>● NTSC/PAL</li> <li>● JPEG</li> <li>● MPEG-1</li> <li>● DPOF 1.1</li> <li>● EXIF 2.2</li> <li>● DCF 1.0</li> </ul>
<b>External Body Dimensions</b>	<p>115 mm (W) by 57.7 mm (H) by 39.5 mm (D)</p> <p>4.5 in (W) by 2.3 in (H) by 1.5 in (D)</p>
<b>Weight</b>	180 grams (5.8 ounces) without batteries
<b>Temperature range</b>	<p>Operational: 5° C to 45° C (41° F to 113° F) at 15% to 85% relative humidity</p> <p>Storage: -30° C to 65° C (-22° F to 149° F) at 15% to 90% relative humidity</p>

Feature	Description
Power	<p>The camera has a maximum steady state power consumption of 2.64 Watts (800mA @ 3.3Vdc).</p> <p>Power sources include:</p> <ul style="list-style-type: none"> <li>● 2 AA batteries (2 non-rechargeable AA batteries included). Acceptable batteries include photo-lithium, “ultra” or “premium” grade high energy alkaline, or rechargeable NiMH. NiMH batteries can be recharged in the camera using the optional HP AC adapter or HP 8886 camera dock.</li> <li>● Optional HP AC adapter (Input: 100-240Vac; Output: 3.3-3.7Vdc @ 2500mA). <ul style="list-style-type: none"> <li>• United States and Canada—C8912 #A2L</li> <li>• Europe—C8912 #UUS</li> <li>• Korea, Australia, and New Zealand—C8912 #UUF</li> </ul> </li> <li>● Optional HP 8886 camera dock (different product numbers for each area - see <b>Purchasing camera accessories</b> on page 93).</li> <li>● DC car adapter</li> </ul> <p>Slow trickle recharging in camera with optional HP AC adapter or HP 8886 camera dock (100% in 15 hours).</p> <p>Automatic advanced power management.</p>
Warranty	<ul style="list-style-type: none"> <li>● 90 day limited warranty in the United States</li> <li>● 1 year limited warranty for the rest of the world</li> </ul>



# Index

## A

- AA batteries 89
- AC power adapter
  - connector on camera 11
  - HP part number 99
  - purchasing 94
- accessories for camera 93
- alkaline batteries 89
- Arrow buttons 11
- audio clips
  - record 12, 26, 41
- audio/video (TV)
  - cable 94
  - connector 55
  - connector on camera 11
- automatic exposure, override 27

## B

- batteries
  - door on camera 12
  - extend life of 92
  - icons 90
  - install 14
  - levels 90
  - rechargeable 91
  - types to use 89
- Best quality setting
  - description 30
- Better quality setting
  - description 30
- blinking lights
  - Memory/USB 10
  - Self-Timer 12

- viewfinder 10
- bonus software 19
- brightening an image 31
- buttons
  - on camera 10

## C

- camera accessories 93
  - Camera Sounds setting 58
  - camera specifications 95
  - camera, turn on/off 16
  - Capture menu
    - using 29
  - capture modes 27
  - compression format 97
  - computer
    - connect camera to 51
  - connections
    - as a USB Mass Storage Device
      - Class (MSDC) 59
    - to computer 51
    - to printer 53
    - to TV 55
  - connectors
    - AC power adapter on camera 11
    - audio/video (TV) 11, 55
    - camera dock 12
    - USB 11
  - consumer support 81
- ## D
- darkening an image 31
  - Date & Time setting 17, 58

- delete
  - during instant review 21
  - from memory card 40
  - video clips during instant review 22
- diagnostic tests for camera 63
- Digital Print Order Format 45
- digital zoom 24
- disk drive, camera as 59
- display images and video clips on TV 56
- display, using 23
- DPOF 45

## E

- e-mail
  - addresses, customizing the Share menu 46
  - images from computer 52
- empty batteries icon 90
- enlarge image 42
- error messages
  - on camera 72
  - on computer 79
- Exposure Compensation, setting 31
- Exposure Mode, setting 27

## F

- files
  - delete from memory card 40
  - DPOF 45
  - size versus quality 30
- flash
  - button 13
  - range 96
  - settings 25
  - using 25

- focus
  - range 96
- format memory card 40
- full batteries icon 90

## G

- Good quality setting
  - description 30

## H

- help from consumer support 81
- HP AC power adapter
  - connector on camera 11
  - purchasing 94
- HP camera dock
  - connect to 12
  - description 9
  - dock insert 9
  - purchasing 93
- HP Instant Share
  - description 9, 43
  - Share button 11, 43
  - Share menu 44
  - turn on/off 43
- HP web sites 81

## I

- Image Display
  - description 11
  - status screen 20
  - using 23
- images
  - brightening 31
  - darkening 31
  - delete 40
  - Exposure Mode setting 27
  - ISO Speed setting 33
  - magnify 42

- moving from internal memory
    - to memory card 61
  - number remaining 23
  - Red-eye Reduction setting 25
  - rotate 39
  - thumbnails 38
  - too dark/light 31
  - unloading camera to
    - computer 51
  - White Balance setting 32
  - install
    - batteries 14
    - HP camera dock 9
    - memory card 15
    - software 18, 19
    - wrist strap 14
  - instant review 21, 22
  - internal memory
    - moving images to memory card 61
  - ISO Speed, setting 33
- L**
- Language setting
    - change 60
    - choose at first startup 16
  - LEDs (lights) on camera
    - Memory/USB 10
    - Self-Timer 12
    - viewfinder 10
  - lights
    - on camera 10, 12
  - Live View
    - button 11
    - using 23
- M**
- Macintosh computer
- N**
- bonus software 19
  - connect to 51
  - install software 19
  - USB setting on camera 59
  - magnify image 42
  - memory card
    - delete files 40
    - install 15
    - moving images from internal memory 61
    - pictures remaining 23
    - purchasing 94
  - Memory/USB light 10
  - menus
    - Capture 29
    - Playback 37
    - Share 44
  - messages
    - on camera 72
    - on computer 79
  - microphone 12
  - MODE button 13
- N**
- NiMH batteries 89
  - number of pictures remaining on
    - memory card 23
- O**
- OK button 11
  - online manual, location 18
  - optical viewfinder 10
  - optical zoom 24
  - over-exposing an image 31
  - override automatic exposure 27
- P**
- photo-lithium batteries 89

- Picture Transfer Protocol 59
- pictures
  - instant review 21
  - share 43
  - take stills 21
- Playback
  - turn on/off 11
  - using 35
- Playback button 11
- Playback menu, using 37
- power
  - battery level icons 90
  - restoring previous settings 16
  - specifications 99
  - switch 12
  - turn on/off 16
- power adapter, HP AC
  - connector on camera 11
  - purchasing 94
- previous settings, restoring 16
- print images
  - directly from camera 53
  - from computer 53
  - using HP Instant Share 43
- printer
  - connect to camera 53
- problems, troubleshooting 63
- product support 81
- PTP 59

**Q**

- quality settings
  - effect on image file size 30

**R**

- range
  - Exposure Compensation 96
  - flash 96

- F-number 95
- focus 96
- rechargeable batteries 91
- record
  - audio clips 12, 26, 41
  - video clips 22
- Red-eye Reduction, setting 25
- remaining pictures count 23
- restoring previous settings 16
- review pictures 21
- reviewing images and video clips 35
- rotate images 39

**S**

- Self-Timer light 12
- Self-Timer mode
  - use 28
- settings, restoring previous 16
- Setup menu, using 57
- Share button 11
- Share menu
  - customize 46
  - description 44
  - e-mail service 46
  - using 44
- share pictures 43
- Shutter button
  - description 13
- shutter speed
  - range 96
- slideshow, display on TV 56
- software, install 18, 19
- sounds of camera 58
- space remaining on memory
  - card 23
- specifications 95
- status screen 20



still pictures, take 21  
support for consumers 81

## T

technical support 81  
thumbnail images, view 38  
Time & Date setting 17, 58  
tripod mount 12  
troubleshoot problems 63  
turn on/off  
    camera power 16  
    camera sounds 58  
    HP Instant Share 43  
    Image Display 11, 23  
    Playback 35  
TV (television)  
    cable to connect camera 94  
    configuration setting 60  
    connect camera to 55  
    connector on camera 11

## U

under-exposing an image 31  
unloading images  
    camera to computer 51  
USB  
    configuration setting 59  
    connector on camera 11

## V

Video button 13  
video clips  
    instant review 22  
    record 22  
Video mode  
    use 22  
Video viewfinder light 10  
viewfinder 10

viewfinder lights 10  
viewing images and video clips  
    35

## W

web sites for HP 81  
White Balance, setting 32  
Windows computer  
    bonus software 19  
    connect to 51  
    install software 18  
wrist strap  
    attaching to camera 14  
    mount on camera 10

## Z

zoom  
    specifications 95  
    use optical or digital 24  
Zoom Out/In buttons 10

