

**hp psc 1300 series  
all-in-one**



**reference guide**

© Copyright Hewlett-Packard Company 2003

All rights are reserved. No part of the document may be photocopied, reproduced, or translated to another language without the prior written consent of Hewlett-Packard Company.

This product incorporates Adobe's PDF technology, which contains an implementation of LZW licensed under U.S. Patent 4,558,302.



Adobe and the Acrobat logo are either registered trademarks or trademarks of Adobe Systems Incorporated in the United States and/or other countries.

Portions Copyright © 1989-2003 Palomar Software Inc. The HP PSC 1300 Series includes printer driver technology licensed from Palomar Software, Inc. [www.palomar.com](http://www.palomar.com)

Copyright © 1999-2003 Apple Computer, Inc.

Apple, the Apple logo, Mac, Mac logo, Macintosh, and Mac OS are trademarks of Apple Computer, Inc., registered in the U.S. and other countries.

Publication number: Q3500-90155

First edition: July 2003

Printed in U.S.A., Mexico, Germany, Singapore, or China

Windows®, Windows NT®, Windows ME®, Windows XP®, and Windows 2000® are U.S.-registered trademarks of Microsoft Corporation.

Intel® and Pentium® are registered trademarks of Intel Corporation.

## notice

The information contained in this document is subject to change without notice and should not be construed as a commitment by the Hewlett-Packard Company.

**Hewlett-Packard assumes no responsibility for any errors that may appear in this document, nor does it make expressed or implied warranty of any kind with regard to this material, including, but not limited to, the implied warranties of merchantability and fitness for a particular purpose.**

The Hewlett-Packard Company shall not be liable for incidental or consequential damages in connection with, or arising out of the furnishing, performance, or use of this document and the program material which it describes.

**Note:** Regulatory information can be found in the **technical information** chapter of this guide.



It is not lawful in many places to make copies of the following items. When in doubt, check with a legal representative first.

- Governmental paper or documents:
  - Passports
  - Immigration papers
  - Selective service papers
  - Identification badges, cards, or insignias
- Governmental stamps:
  - Postage stamps
  - Food stamps
- Checks or drafts drawn on Governmental agencies
- Paper currency, traveler's checks, or money orders
- Certificates of deposit
- Copyrighted works

## safety information

**Warning!** To prevent fire or shock hazard, do not expose this product to rain or any type of moisture.

Always follow basic safety precautions when using this product to reduce risk of injury from fire or electric shock.

### Warning! Potential shock hazard

- 1 Read and understand all instructions in the Setup Poster.
- 2 Use only a grounded electrical outlet when connecting the device to a power source. If you do not know whether the outlet is grounded, check with a qualified electrician.
- 3 Observe all warnings and instructions marked on the product.
- 4 Unplug this product from wall outlets before cleaning.
- 5 Do not install or use this product near water or when you are wet.
- 6 Install the product securely on a stable surface.
- 7 Install the product in a protected location where no one can step on or trip over the line cord, and where the line cord will not be damaged.
- 8 If the product does not operate normally, see the online Troubleshooting help.
- 9 No operator-serviceable parts inside. Refer servicing to qualified service personnel.
- 10 Use in a well-ventilated area.

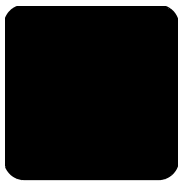

# contents

<b>1</b>	<b>quick start</b> . . . . .	<b>1</b>
	front panel overview . . . . .	1
	photo memory card overview . . . . .	3
	front panel status lights . . . . .	3
	use your hp psc with a computer . . . . .	6
<b>2</b>	<b>load originals and load paper</b> . . . . .	<b>11</b>
	load originals . . . . .	11
	load an original photo on the glass . . . . .	12
	load letter or A4 paper . . . . .	12
	load envelopes . . . . .	14
	load postcards, Hagaki cards, or 4 by 6 inch (10 by 15 cm) photo paper recommended papers . . . . .	14 15
	load other types of paper in the paper tray . . . . .	15
	set the paper type . . . . .	15
	avoid jams . . . . .	16
<b>3</b>	<b>use a photo memory card</b> . . . . .	<b>17</b>
	what is a memory card? . . . . .	17
	insert a memory card and save the files to your computer . . . . .	18
	print photos by using a proof sheet . . . . .	19
	use the hp photo & imaging gallery . . . . .	23
<b>4</b>	<b>use the copy features</b> . . . . .	<b>25</b>
	make copies . . . . .	25
	perform special copy jobs . . . . .	26
	stop copying . . . . .	28
<b>5</b>	<b>use the scan features</b> . . . . .	<b>29</b>
	scan an original . . . . .	29
	stop scanning . . . . .	30
<b>6</b>	<b>maintain your hp psc</b> . . . . .	<b>31</b>
	clean the glass . . . . .	31
	clean the lid backing . . . . .	31
	clean the exterior . . . . .	32
	work with print cartridges . . . . .	32
	self-maintenance sounds . . . . .	40
<b>7</b>	<b>get hp psc 1300 series support</b> . . . . .	<b>41</b>
	get support and other information from the Internet . . . . .	41
	hp customer support . . . . .	41
	prepare your hp psc for shipment . . . . .	44
	hp distribution center . . . . .	45

- 8 warranty information . . . . .47**
  - duration of limited warranty . . . . .47
  - warranty service . . . . .47
  - warranty upgrades . . . . .47
  - returning your hp psc for service . . . . .48
  - hewlett-packard limited global warranty statement . . . . .48
  
- 9 technical information . . . . .51**
  - paper specifications . . . . .51
  - photo memory card specifications . . . . .52
  - physical specifications . . . . .52
  - power specifications . . . . .52
  - environmental specifications . . . . .52
  - environmental product stewardship program . . . . .53
  - regulatory notices . . . . .54
  - declaration of conformity . . . . .56
  
- 10 hp instant share setup and use . . . . .57**
  - use hp instant share in five easy steps (Windows) . . . . .57
  - send a photo or image using your hp psc (Macintosh) . . . . .60
  - why should I register with hp instant share (Windows)? . . . . .61
  
- 11 troubleshooting information . . . . .63**
  - installation troubleshooting . . . . .63
  - operational troubleshooting . . . . .69
  
- index. . . . .73**

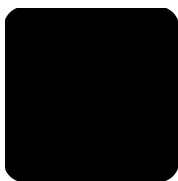

# get help

This Reference Guide contains information on using your HP PSC and provides additional troubleshooting assistance for the installation process. The Reference Guide also contains information on how to order supplies and accessories, technical specifications, support, and warranty information.

The table below lists additional sources of information for your HP PSC.

help	description
Setup Poster	The Setup Poster provides instructions for setting up and configuring your HP PSC. Make sure you use the correct poster for your operating system (Windows or Macintosh).
HP Photo & Imaging Help	The HP Photo & Imaging Help provides detailed information on using the software for your HP PSC. <b>For Windows users:</b> Go to the <b>HP Director</b> , and click <b>Help</b> . <b>For Macintosh users:</b> Go to the <b>HP Director</b> , and click <b>Help</b> , then click <b>hp photo and imaging help</b> .
Reference Guide	The Reference Guide you have in your hands contains information on using your HP PSC and provides additional troubleshooting assistance for the installation process. The Reference Guide also contains information on how to order supplies and accessories, technical specifications, support, and warranty information.
Troubleshooting help	To access troubleshooting information: <b>For Windows users:</b> In the <b>HP Director</b> , click <b>Help</b> . Open the Troubleshooting book in the HP Photo & Imaging Help, then follow the links to general troubleshooting as well as links to Troubleshooting help that is specific to your HP PSC. Troubleshooting is also available from the <b>Help</b> button that appears on some error messages. <b>For Macintosh users:</b> Open the Apple Help Viewer, click <b>hp photo and imaging troubleshooting</b> , then click <b>hp psc 1300 series</b> . There is also a Troubleshooting chapter available in this Reference Guide.
Internet help and technical support	If you have Internet access, you can get more information from the HP website at: <b><a href="http://www.hp.com/support">www.hp.com/support</a></b> The website also provides answers to frequently asked questions.
Readme file	After you install your software, you can access the Readme file (if any) from either the HP PSC 1300 Series CD-ROM or the HP PSC 1300 Series program folder. A Readme file contains late-breaking information that does not appear in the Reference Guide or the online help.



help	description
Dialog-box help (Windows only)	<b>For Windows:</b> Use one of the following ways to find information on a specific feature: <ul style="list-style-type: none"><li data-bbox="369 210 669 239">• Right-click on the feature</li><li data-bbox="369 244 732 274">• Select the feature and press <b>F1</b></li><li data-bbox="369 279 1047 309">• Select the <b>?</b> in the upper-right corner then click on the feature</li></ul>

# 1

## quick start

Your HP PSC can be used for making copies and printing photos from a photo memory card without turning on your computer. You can do more with your HP PSC by using the HP Photo & Imaging Director (HP Director) software that you installed on your computer during the initial setup. The HP Director includes troubleshooting tips, product-specific help, and enhanced copy, scan, and photo functionality. For more information on the use of the HP Director, see **use your hp psc with a computer** on page 6.

This section contains the following topics:

- **front panel overview** on page 1
- **photo memory card overview** on page 3
- **front panel status lights** on page 3
- **use your hp psc with a computer** on page 6

### front panel overview

Use the graphic and table below to become familiar with the front panel features of your HP PSC.

**Note:** The front panel cover must be attached to the HP PSC by removing the adhesive backing and placing the cover in the appropriate location. The HP PSC will not operate unless the front panel cover is attached properly. If your HP PSC is not operating properly, refer to the setup instructions for information about attaching the front panel cover.

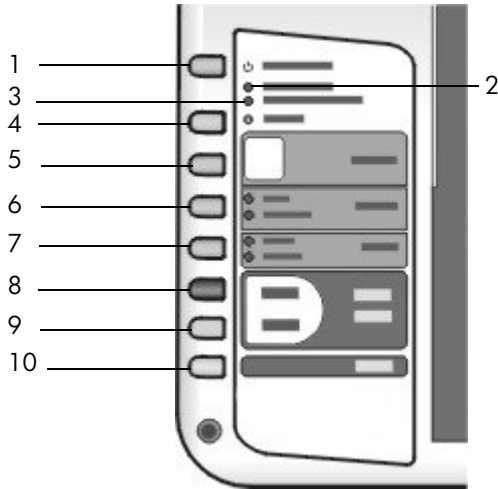

feature	purpose
1	<b>On/Resume:</b> turns the HP PSC on and off. Also, resumes a copy or print job after a jam or other error. If the HP PSC is in an error state, you can turn it off by pressing On/Resume for 3 seconds. <b>Warning!</b> When the HP PSC is off, a minimal amount of power is still supplied to the device. Unplug the power cord to completely disconnect the power supply to the HP PSC.
2	<b>Check Paper:</b> lights up to indicate the need to load paper or remove a paper jam.
3	<b>Check Print Cartridge:</b> lights up to indicate the need to reinsert or replace the print cartridge or close the print carriage access door.
4	<b>Cancel:</b> stops a job or exits button settings.
5	<b>Copies (1-9):</b> changes the number of copies for a copy job.
6	<b>Size:</b> changes the copy image size to either 100% or Fit to Page.
7	<b>Paper Type:</b> changes the paper type to Plain or Photo.
8	<b>Start Copy, Black:</b> starts a black-and-white copy.
9	<b>Start Copy, Color:</b> starts a color copy.
10	<b>Scan:</b> starts a scan of an original from the glass.



## photo memory card overview

Your HP PSC can read CompactFlash (I, II), Memory Sticks, MMC, Secure Digital, SmartMedia, and xD memory cards.

Your HP PSC features four slots for memory cards, shown in the illustration below with the memory cards that correspond to each slot.

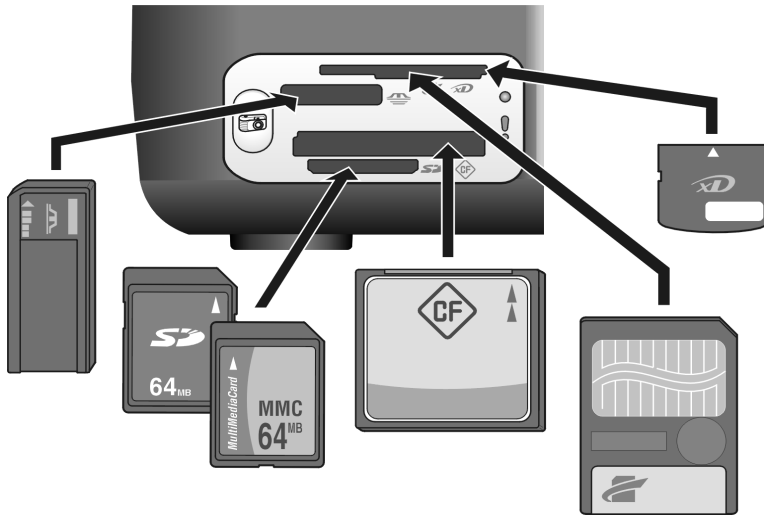

From top to bottom, the slots are configured as follows:

- Slot 1: SmartMedia on top of slot (with side shown down), xD on bottom
- Slot 2: Memory Stick, Magic Gate Memory Stick, Memory Stick Duo (with user-supplied adapter), Memory Stick Pro
- Slot 3: CompactFlash (I, II)
- Slot 4: Secure Digital, MultiMediaCard (MMC)

For more information on photo memory cards, see **use a photo memory card** on page 17.

## front panel status lights

Status lights on the front panel provide information about tasks that your HP PSC is currently performing or about maintenance tasks that you need to perform on the device. For example, you can tell if the device is on or off, if it is processing a black-and-white or color copy, if it is out of paper, or if there is a paper jam.

All status lights on the front panel are reset to the default display after two minutes unless there is an error.

Review the graphic and the table on the next page to become familiar with the front-panel status lights that provide information about tasks that your HP PSC is currently performing.

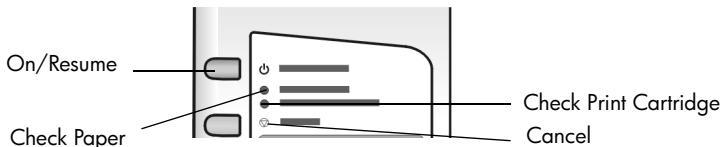

on light (green)	black copy area (backlight)	color copy area (backlight)	explanation	what to do?
Light is off.	Light is off.	Light is off.	Your HP PSC is turned off.	Press the On/Resume button to turn your HP PSC on.
Light is on.	Light is on.	Light is on.	Your HP PSC is turned on and is ready for use.	Begin a scan, copy, or print job from the front panel or from the software.
Light is blinking.	Light is on.	Light is on.	Your HP PSC is processing a print, scan, or maintenance job.	Wait for your HP PSC to finish processing the job.
Light is blinking.	Light is blinking.	Light is on.	Your HP PSC is processing a black-and-white copy job.	Wait for your HP PSC to finish processing the job.
Light is blinking.	Light is on.	Light is blinking.	Your HP PSC is processing a color copy job.	Wait for your HP PSC to finish processing the job.
Blinks faster for 3 seconds and then stays illuminated.	Light is on or blinking.	Light is on or blinking.	Your HP PSC is busy doing another task.	Wait for the current job to be completed before starting another job.

In addition to providing information about current tasks, the lights on the front panel can also indicate error conditions, as described in the table below.

If the On light, Check Print Cartridge light, Check Paper light, and Start Copy, Black and Start Copy, Color lights are all flashing, do the following:

- 1 Verify that the front-panel overlay is attached to the HP PSC.
- 2 Turn your HP PSC off and on by disconnecting the power cord and reconnecting.

on light (green)	check paper light	check print cartridge light	explanation	what to do?
Rapid blinking for 20 seconds.	Light is off.	Light is off.	The HP PSC is trying to scan and there is a communication problem.	Verify that your computer is on and is connected to the HP PSC. Verify that the HP PSC software is installed.

on light (green)	check paper light	check print cartridge light	explanation	what to do?
Light is on.	Light is blinking.	Light is off.	The paper tray is empty, or the HP PSC has a paper jam, or the paper size setting and paper in paper tray are not the same.	<ul style="list-style-type: none"> <li>• Load paper, or remove the paper jam.</li> <li>• Change paper in paper tray to correct size.</li> <li>• Change layout size on proof sheet.</li> <li>• Change paper size on the computer software.</li> </ul> <p>Then press On/ Resume to continue.</p>
Light is on.	Light is off.	Light is blinking.	<ul style="list-style-type: none"> <li>• Print cartridge access door might be open.</li> <li>• Print cartridges might be missing or not installed properly.</li> <li>• Tape might not have been removed from the print cartridges.</li> <li>• There might be a problem with the print cartridge.</li> </ul>	<ol style="list-style-type: none"> <li><b>1</b> Remove the print cartridges and make sure the tape has been removed.</li> <li><b>2</b> Re-insert the print cartridges and make sure they are properly seated.</li> <li><b>3</b> Close the access door.</li> </ol> <p>For more information on this condition, click the HP PSC status icon in the system tray on your computer (Windows only).</p>
Light is on.	Light is blinking.	Light is blinking.	The print carriage is stalled.	Open the print carriage access door and make sure the carriage is not obstructed.
Light is blinking.	Light is blinking.	Light is blinking.	An error caused the HP PSC to stop functioning.	<ol style="list-style-type: none"> <li><b>1</b> Turn the HP PSC off and then on.</li> <li><b>2</b> Restart your computer.</li> <li><b>3</b> If the problem is not corrected, unplug the HP PSC and plug it in again.</li> </ol> <p>If the problem persists, contact HP.</p>

on light (green)	check paper light	check print cartridge light	explanation	what to do?
Light is off.	Light is blinking.	Light is off.	<p>There is a problem with the layout size indicated on the proof sheet.</p> <ul style="list-style-type: none"> <li>• Proof sheet errors also cause an error message to appear on your computer.</li> </ul>	<ol style="list-style-type: none"> <li>1 Verify the appropriate bubble is filled in on the proof sheet, and that it is filled in dark enough.</li> <li>2 Press the Photo button next to the memory card slots to resume printing.</li> </ol>

## use your hp psc with a computer

If you installed the HP PSC software on your computer according to the Setup Poster, you can access all the features of the HP PSC using the HP Director.

This section contains the following topics:

- **open the hp director for Windows users** on page 6
- **open the hp director for Macintosh users** on page 8

### open the hp director for Windows users

- 1 Do one of the following to open the HP Director:
  - Double-click the **HP Director** icon on the desktop.
  - In the Windows taskbar, click **Start**, point to **Programs** or **All Programs (XP)**, point to **Hewlett-Packard**, point to **HP PSC 1300 Series**, then select **HP Photo & Imaging Director**.
- 2 In the **Select Device** box, click to see a list of installed HP devices supported by this software.
- 3 Select **HP PSC 1300 Series**.

**Note:** The HP Director graphic below might appear differently on your computer. The HP Director is customized based on the HP device that is selected. If your device is not equipped with a particular feature (such as fax capability), then the icon for that feature will not display in the HP Director on your computer. Some HP devices might show additional buttons that are not shown below.

**Tip:** If the HP Director on your computer does not contain any icons, an error might have occurred during the software installation. To correct this, use the Control Panel in Windows to completely uninstall the HP Director software, and then reinstall the HP Director.

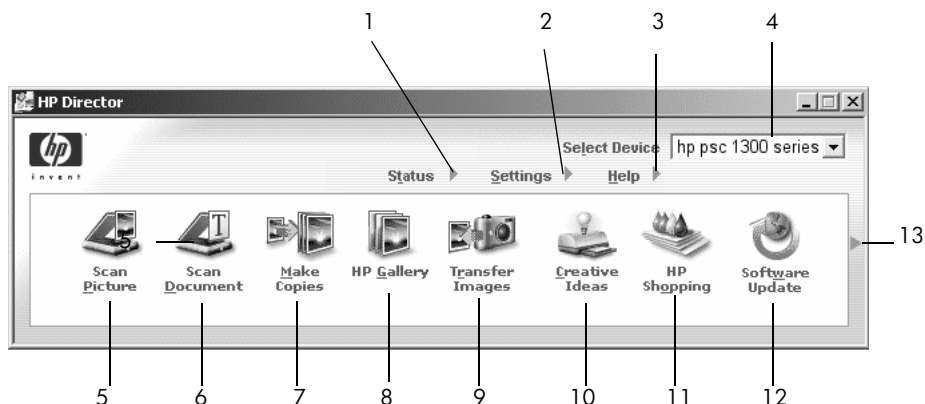

feature	purpose
1	<b>Status:</b> select this feature to display the current status of your HP PSC.
2	<b>Settings:</b> select this feature to view or change various settings for your HP PSC, such as print, scan, or copy.
3	<b>Help:</b> select this feature to access the HP Photo & Imaging Help, which provides software help, a product tour, troubleshooting information for your HP PSC, and HP PSC product-specific help.
4	<b>Select Device:</b> use this feature to select the device you want to use from the list of installed HP devices.
5	<b>Scan Picture:</b> use this feature to scan an image and display it in the HP Photo & Imaging Gallery.
6	<b>Scan Document:</b> use this feature to scan text and display it in the selected text editing software program.
7	<b>Make Copies:</b> use this feature to display the <b>Copy</b> dialog box where you can select the copy quality, number of copies, color, size, and then start a copy.
8	<b>HP Gallery:</b> use this feature to display the HP Photo & Imaging Gallery, where you can view and edit images, print photos in multiple sizes, make and print a photo album, share images through e-mail or a website, or make a multimedia CD.
9	<b>Transfer Images:</b> use this feature to transfer images from a photo memory card.
10	<b>Creative Ideas:</b> use this feature to learn about creative ways to use your HP PSC.
11	<b>HP Shopping:</b> use this feature to shop for HP products.
12	<b>Software Update:</b> use this feature to check for software updates for your HP PSC.
13	Click this <b>arrow</b> to display tool tips that explain each of the HP Director options.

## open the hp director for Macintosh users

Use one of the following methods to launch or access the HP Director, depending on which Macintosh OS you are using.

### open the hp director (all-in-one) using Macintosh OS X

If you are using Macintosh OS X, the HP Director (All-in-One) is launched automatically during the HP Photo and Imaging software installation, and causes the HP Director (All-in-One) icon to be created in the Dock for your device. Access the device capabilities via the HP Director menu that is associated with the HP Director (All-in-One) icon.

**Tip:** If you do not want the HP Director to launch automatically each time you start your Macintosh, you can change this setting in the HP Director Settings menu.

To display the HP Director menu:

- ➔ In the Dock, click the HP Director (All-in-One) icon for your device.

The HP Director menu appears as shown below. Refer to the legend for a brief description of the HP Director features.

**Note:** If you install more than one HP device, an HP Director icon for each device is appears in the Dock. For example, if you have an HP scanner and an HP PSC installed, two HP Director icons are present in the Dock, one for the scanner, and one for the HP PSC. However, if you installed two of the same kind of device (for example, two HP PSC devices) only one HP Director icon is displayed in the Dock to represent all devices of that kind.

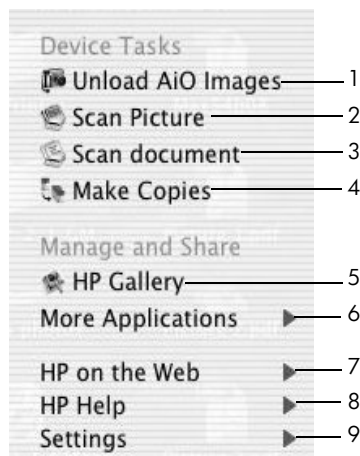

feature	purpose
1	<b>Unload AiO Images:</b> use this feature to unload images from a photo memory card.
2	<b>Scan Picture:</b> use this feature to scan an image and display it in the HP Photo and Imaging Gallery.

feature	purpose
3	<b>Scan document:</b> use this feature to scan text and display it in the selected destination text editing software program.
4	<b>Make Copies:</b> use this feature to make a copy in black and white or color.
5	<b>HP Gallery:</b> use this feature to display the HP Photo and Imaging Gallery to view and edit images.
6	<b>More Applications:</b> use this feature to select other applications on your computer.
7	<b>HP on the Web:</b> use this feature to select an HP website.
8	<b>HP Help:</b> use this feature to select a source for help with your HP PSC.
9	<b>Settings:</b> use this feature to change device settings.

### open the hp photo and imaging director using Macintosh OS 9

In Macintosh OS 9, the HP Director is launched automatically during the HP Photo and Imaging software installation, and the HP Director appears as an alias on the desktop. Use one of the following methods to launch the HP Director.

- ➔ Double-click the **HP Photo and Imaging Director** alias on the desktop.
- ➔ Double-click **HP Photo and Imaging Director** in the Applications:Hewlett-Packard:HP Photo and Imaging Software:HP Photo and Imaging Director folder.

The HP Photo and Imaging Director displays only the icons that pertain to the selected device. For more information, see the onscreen hp photo and imaging help that came with your software.

The following figure shows some of the features available through the HP Director for Macintosh OS 9. Consult the legend for a brief explanation of specific features.

**Note:** The HP Photo and Imaging Director graphic below might appear differently on your computer. The HP Photo and Imaging Director is customized based on the HP device that is selected. If your device is not equipped with a particular feature (such as fax capability), then the icon for that feature will not display in the HP Photo and Imaging Director on your computer. Some HP devices might show additional buttons that are not shown below.

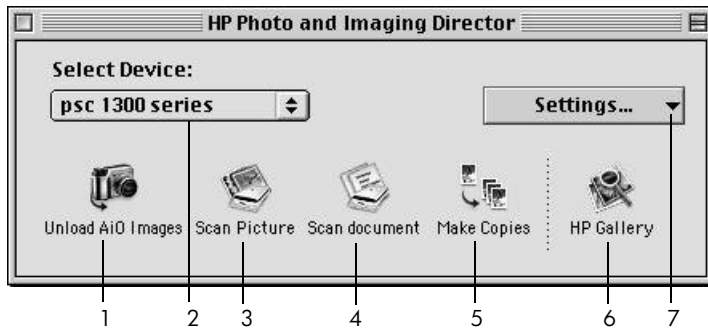

feature	purpose
1	<b>Unload AiO Images:</b> use this feature to unload images from a photo memory card.
2	<b>Select Device:</b> use this pull-down list to select the HP device you want to use.
3	<b>Scan Picture:</b> use this feature to scan an image and display it in the HP Photo and Imaging Gallery.
4	<b>Scan document:</b> use this feature to scan text and display it in the selected destination text editing software program.
5	<b>Make Copies:</b> use this feature to make a copy in black and white or color.
6	<b>HP Gallery:</b> use this feature to display the HP Photo and Imaging Gallery to view and edit images.
7	<b>Settings:</b> use this pull-down list to provide access to device settings.



# 2

## load originals and load paper

You can copy and scan originals loaded on the glass. You can also print and copy onto a variety of paper types and paper sizes. It is important that you choose the right paper and make sure that it is loaded correctly and not damaged.

This section contains the following topics:

- **load originals** on page 11
- **load an original photo on the glass** on page 12
- **load letter or A4 paper** on page 12
- **load envelopes** on page 14
- **load postcards, Hagaki cards, or 4 by 6 inch (10 by 15 cm) photo paper** on page 14
- **recommended papers** on page 15
- **load other types of paper in the paper tray** on page 15
- **set the paper type** on page 15
- **avoid jams** on page 16

### load originals

Review the procedure below for loading originals on the glass of your HP PSC.

**Note:** Some copy options, such as Fit to Page, will not work correctly if the glass and lid backing are not clean. For more information, see **clean the glass** and **clean the lid backing** on page 31.

- 1 To load an original, lift the lid and place the original face down on the left front corner of the glass with the sides of the original touching the left and bottom edges.

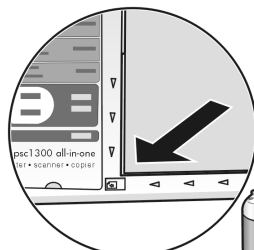

Top edge of original

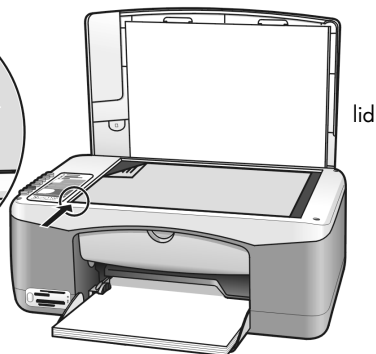

- 2 Close the lid.

For information on making a copy, see **make copies** on page 25. For more information on scanning a document, see **scan an original** on page 29.

## load an original photo on the glass

You can make a copy of an original photo from the glass of your HP PSC. It is important that you load the original photo on the glass properly to get the best possible copy.

- 1 Load your original photo face down on the left front corner of the glass. Position the photo on the glass so the long edge of the photo is along the front edge of the glass.

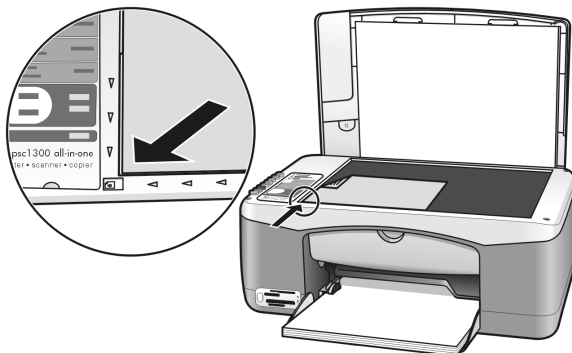

- 2 Close the lid.

For more information on special copy jobs, or making borderless copies of photos, see **perform special copy jobs** on page 26.

## load letter or A4 paper

The following describes the basic procedure for loading letter or A4 paper into the HP PSC. For best results, adjust the paper settings each time you change paper types or paper sizes. For more information, see **set the paper type** on page 15, and **avoid jams** on page 16.

**Note:** There are specific considerations for loading certain types of paper, postcards, and envelopes. After you review the procedure for loading letter and A4 paper, see **load envelopes** on page 14, and **load postcards, Hagaki cards, or 4 by 6 inch (10 by 15 cm) photo paper** on page 14, and **load other types of paper in the paper tray** on page 15.

- 1 Lower the paper tray, and if necessary, slide the paper-width guide to the outermost position.
- 2 Fold out the paper-tray extender to catch paper as it exits the device.

**Tip:** For best results when loading legal-size paper, fold in the paper-tray extender before loading the paper to avoid a paper jam.



- 3 Tap the stack on a flat surface to align the edges of the paper, and then check the paper for the following:
  - Make sure it is free of rips, dust, wrinkles, and curled or bent edges.
  - Make sure all the paper in the stack is the same size and type.
- 4 Insert paper into the paper tray with the print side down until it stops. To avoid bending the paper, make sure you do not push the paper in too far, or push too hard. If you are using letterhead, insert the top of the page first.

Do not use too much paper. Check that the stack of paper contains several sheets but is no higher than the top of the paper-width guide.

**Note:** Forcing the paper too far into the HP PSC might cause multiple sheets of paper to be fed through the print mechanism, or cause a paper jam.

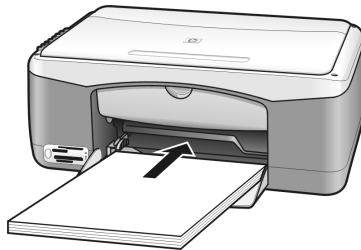

- 5 Slide the paper-width guide in until it stops at the edge of the paper. Make sure that the paper stack lies flat in the paper tray and fits under the tab of the paper-width guide.

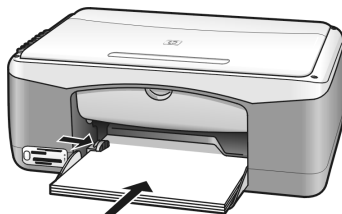

## load envelopes

Use the print feature of your word processing software to print to envelopes with your HP PSC. Use envelopes for printing only; copying on to an envelope is not recommended. Do not use shiny or embossed envelopes, or envelopes that have clasps or windows. You can load the paper tray with one or multiple envelopes.

**Note:** Consult the help files in your word processing software for details on how to format text for printing on envelopes.

- 1 Remove all paper from the paper tray.
- 2 Slide an envelope into the tray, with the envelope flap up and to the left (print side down), until it stops. Do not force the envelope in too far.



- 3 Adjust the paper-width guide against the envelope. Be careful not to bend the envelope. Do not overload the paper tray when loading multiple envelopes. Make sure the stack of envelopes is no higher than the top of the paper-width guide.

## load postcards, Hagaki cards, or 4 by 6 inch (10 by 15 cm) photo paper

The following is the procedure for loading postcards, Hagaki cards, or 4 by 6 inch (10 by 15 cm) photo paper.

- 1 Remove all paper from the paper tray, and then slide a stack of cards into the tray until it stops. Insert the short edge of the card into the HP PSC first. Make sure the print side faces down.

**Note:** If you are using photo paper with perforated tabs, load the photo paper so that the tabs face out towards you.



- 2 Adjust the paper-width guide against the cards until it stops. Make sure the cards fit within the tray. Do not overload it. The stack should be no higher than the top of the paper-width guide.

## recommended papers

For the best print quality, use HP papers. Paper that is too thin, paper that has a slick texture, or paper that stretches easily can cause paper jams. Paper that has a heavy texture or does not accept ink can cause printed images to smear, bleed, or not be filled in completely. For more information about HP papers, check our website at:

[www.hp.com/support](http://www.hp.com/support)

## load other types of paper in the paper tray

The following table provides guidelines for loading nonstandard types of paper. For best results, adjust the paper settings each time you change the paper type or paper size. For more information, see **set the paper type** on page 15.

**Note:** Some paper types might not be available in your country/region.

**Note:** Photo paper might curl when you remove it from the box. If this occurs, curl the paper the opposite way to flatten it before inserting it into the HP PSC.

paper	tips
HP papers	<ul style="list-style-type: none"> <li>• HP Premium Paper: locate the gray arrow on the nonprinting side of the paper, and then load paper with the arrow side facing up.</li> <li>• HP Greeting Card Paper, HP Glossy Greeting Card Paper, or HP Textured Greeting Cards: insert a small stack of greeting cards with the print side down, into the paper tray until it stops.</li> </ul>
Labels (works only with printing)	<ul style="list-style-type: none"> <li>• Always use letter or A4 label sheets designed for use with HP inkjet products (like Avery Inkjet Labels), and make sure that the labels are not over two years old.</li> <li>• Fan the stack of labels to make sure none of the pages are sticking together.</li> <li>• Place a stack of label sheets on top of standard paper in the paper tray, print side down. Do <i>not</i> insert labels one sheet at a time.</li> </ul>

## set the paper type

If you want to use a different type of paper, load that paper in the paper tray. You should then change the paper type settings to ensure the best print quality. This setting refers to copy settings only. If you want to set the paper type for printing, set the properties from the Print dialog box in the software program on your computer.

The following procedure describes how to change the paper type setting on your HP PSC.

- 1 Load paper into the HP PSC.
- 2 Press **Paper Type** on the front panel to change the setting to **Plain** or **Photo**.

**Note:** If you are printing photos from a proof sheet, fill in the paper type bubble on the proof sheet that matches the paper type you have loaded in the HP PSC.

## avoid jams

To avoid jams, remove papers from completed print or copy jobs frequently from the paper tray. Excessive amounts of paper from completed print or copy jobs in the paper tray might back up into the HP PSC and cause a paper jam. Also, for best results, use recommended papers, and load paper correctly. For more information see, **recommended papers** on page 15, and **load letter or A4 paper** on page 12.

# 3

## use a photo memory card

This HP PSC can access the memory cards used in almost any digital camera so you can print, store, manage, and share your digital photos in some very exciting ways.

This section contains the following topics:

- **what is a memory card?** on page 17
- **insert a memory card and save the files to your computer** on page 18
- **print photos by using a proof sheet** on page 19
- **use the hp photo & imaging gallery** on page 23

### what is a memory card?

If your digital camera uses a memory card to store photos, you can insert the memory card in your HP PSC to print or save your photos.

You can print a proof sheet, which might be several pages long and shows thumbnail views of photos stored on the memory card, and print photos from the memory card, even if your HP PSC is not connected to a computer.

Your HP PSC can read CompactFlash (I, II), Memory Sticks, MultiMediaCard (MMC), Secure Digital, SmartMedia, and xD memory cards.

Your HP PSC features four slots for memory cards, shown in the illustration below with the memory cards that correspond to each slot.

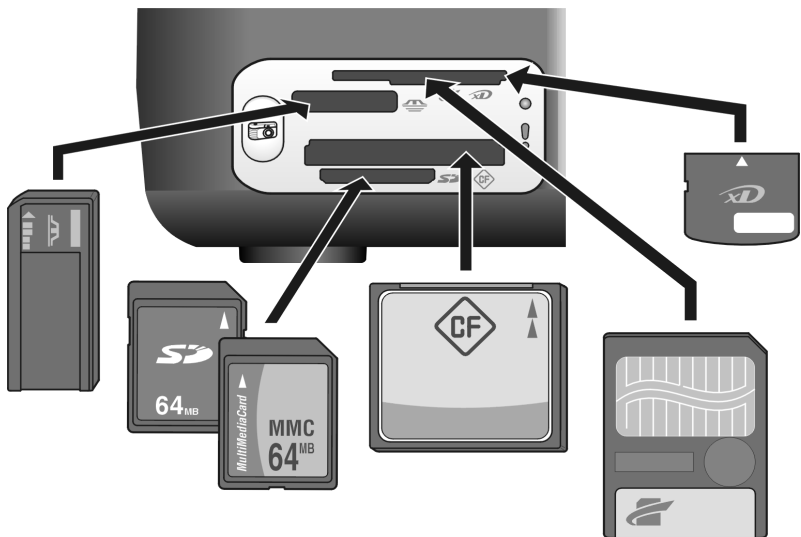

From top to bottom, the slots are configured as follows:

- Slot 1: SmartMedia on top of slot (with side shown down), xD on bottom
- Slot 2: Memory Stick, Magic Gate Memory Stick, Memory Stick Duo (with user-supplied adapter), Memory Stick Pro
- Slot 3: CompactFlash (I, II)
- Slot 4: Secure Digital, MultiMediaCard (MMC)

**Note:** By default, Windows XP will format a memory card of 8 MB or less and 64 MB or more with FAT32 format. Digital cameras and other devices use the FAT (FAT16 and FAT12) format and cannot operate with a FAT32 formatted card. Either format your card in your camera or select the FAT format to format your card in a Windows XP PC.

For some basic memory card troubleshooting information included in this Reference Guide, see **photo memory card troubleshooting** on page 70.

## insert a memory card and save the files to your computer

After you take photos with your digital camera, you can print them immediately or save them directly to your computer.

- 1 Insert the memory card into the appropriate slot on your HP PSC.

When the memory card is inserted correctly, the Photo button on the front panel remains on. The Read Status LED next to the card slots blinks green when the card is being accessed. It can take several minutes for the HP PSC to read a memory card that contains many images.

If you insert a memory card backwards, the Photo Error LED next to the card slots blinks amber and your computer might display an error message such as Card is not fully inserted.

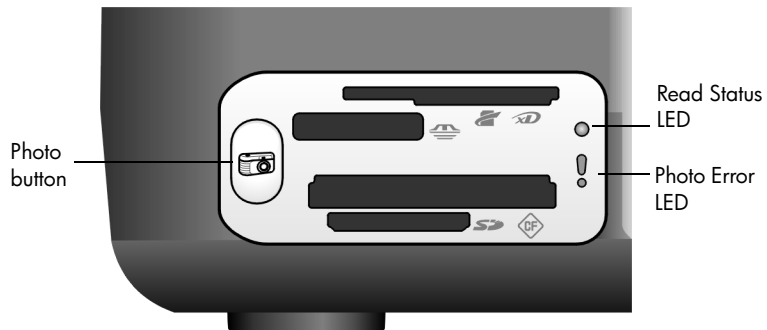

**Warning!** Never attempt to remove a memory card while it is being accessed. Doing so can damage files on the card. You can safely remove a card only when the Read Status LED next to the slot is off.

- 2 A dialog box on your computer automatically asks you if you want to transfer the memory card's contents to the computer.
- 3 Press the appropriate button in the dialog box to begin the process. This saves all the photos from the memory card to your computer that have not already been transferred before.



**Note:** You can cancel the transfer process only from your computer. The HP PSC's Cancel button does not stop transfers. Click the appropriate button in the dialog box.

**For Windows:** by default, files are saved in month and year folders depending on when the photos were taken. The folders are created under the **C:\Documents and Settings\username\My Documents\My Pictures** folder in Windows XP and Windows 2000.

**For Macintosh:** by default, files are saved to the computer in **Hard Drive:Documents:HP All-in-One Data:Photos** folder (OS 9) or **Hard Drive:Users:User Name:Pictures:HP Photos** folder (OS X).

On a Macintosh you can use iPhoto as a transfer destination instead of the HP Photo and Imaging Gallery. See the onscreen **hp photo and imaging help** that came with your software.

**Note:** You can only use one memory card in your HP PSC at a time.

**Tip:** Is your hard disk full? If your computer is equipped with an internal or external CD writer, you can organize large collections of digital photos on CDs by using the Memories Disc feature of the HP Photo & Imaging Gallery.

For information on using Memories Disc on a Macintosh, see the onscreen **hp photo and imaging help** that came with your software.

## print photos by using a proof sheet

A proof sheet is a simple and convenient way to make prints directly from a memory card without the need for a computer. A proof sheet, which might be several pages long, shows thumbnail views of photos stored on the memory card. An index number appears under each thumbnail along with a circle.

This section contains the following topics:

- **print a proof sheet** on page 20
- **complete the proof sheet** on page 20
- **print photos by scanning a proof sheet** on page 21
- **create borderless prints** on page 22

**Tip:** You can optimize the quality of the photos you print with your HP PSC by purchasing a photo print cartridge. Remove the black print cartridge and insert the photo print cartridge in its place. Insert the black print cartridge in a print cartridge protector so the print cartridge's nozzles do not become clogged. With the tri-color print cartridge and photo print cartridge installed, you have a six-ink system, which provides enhanced quality photos.

For more information, see **order print cartridges** on the inside back cover and **work with print cartridges** on page 32.

**Note:** The HP PSC does not operate properly with only one ink cartridge inserted. The Check Print Cartridge light blinks to alert you to this situation.

After printing a proof sheet, you fill in the circles under the photos you want to print, and place the proof sheet on the glass. The HP PSC scans the proof sheet and prints the photos you selected, without a computer.

There are three steps to using a proof sheet to print photos:

- Printing a proof sheet
- Completing the printed proof sheet to select photos, number of copies, and layout
- Scanning the completed proof sheet to print the selected photos

### print a proof sheet

**Note:** Before printing a proof sheet, make sure to remove all documents from the glass of the HP PSC. If there is anything on the glass when you press the Photo button, an error results. Make sure the paper tray contains letter or A4 paper; otherwise the proof sheet does not print.

- 1 Insert the memory card into the appropriate slot on your HP PSC. Wait for the **Photo** button to remain lit before proceeding.
- 2 Press the **Photo** button to print a proof sheet.

The proof sheet prints starting with the last 20 photos stored on the memory card since these are the most recent photos taken. Additional pages print if there are more than 20 photos on the card. If the memory card is empty, no proof sheet is printed and an error message appears on the computer.

- 3 Remove the proof sheet from the HP PSC.

**Tip:** If you want to cancel proof sheet printing after the first sheet of the most recently taken 20 photos, wait until the first sheet has printed, and then press Cancel. If you press Cancel earlier, the proof sheet is unusable for selecting and printing photos.

### complete the proof sheet

















After you have printed a proof sheet, you can select photos to be printed.

Photo Proof Sheet



hp psc 1300  
all-in-one

**Step 1:** to select photo(s), fill in bubble(s) underneath with a dark pen.  
**Step 2:** decide whether printing on large or small paper size.  
**Step 3:** for large paper, select one paper type and one layout.  
**Step 4:** place sheet on scanner glass at front left corner. Press 

Print all images on memory card

				
<input type="radio"/> 1	<input type="radio"/> 2	<input type="radio"/> 3	<input type="radio"/> 4	<input type="radio"/> 5
				
<input type="radio"/> 6	<input type="radio"/> 7	<input type="radio"/> 8	<input type="radio"/> 9	<input type="radio"/> 10
				
<input type="radio"/> 11	<input type="radio"/> 12	<input type="radio"/> 13	<input type="radio"/> 14	<input type="radio"/> 15
				
<input type="radio"/> 16	<input type="radio"/> 17	<input type="radio"/> 18	<input type="radio"/> 19	<input type="radio"/> 20

Select large paper type  
Select one layout below

<input type="radio"/> plain	<input type="radio"/> photo	<input type="radio"/> small paper, photo paper only
		

- 1 Select the photos to print by doing one of the following:
  - If you only want to print some photos, fill in the circles located under the thumbnail images on the proof sheet with a dark pen.
  - If you want to print all the photos, fill in the circle next to the **Print all images on memory card** option located just before the first row of thumbnails.
- 2 Select only one paper type by filling in the circle under the appropriate paper type on the proof sheet:
  - **plain**
  - **photo**
  - **small paper** (4 by 6 inch (10 by 15 cm) photo paper for borderless printing (with tear-off tab))
- 3 If you selected **plain** paper or **photo** paper, select only one layout by filling in the circle under the appropriate layout on the proof sheet.
 

**Note:** If you selected small paper, do not select any layout. You must complete each of these steps before proceeding.

### print photos by scanning a proof sheet

**Tip:** Make sure the glass of the HP PSC is completely clean or the proof sheet might not scan properly. See **clean the glass** on page 31 for instructions. Make sure there is nothing but a completed proof sheet on the glass or an error results when you press the Photo button.

**Note:** You might want to use a photo print cartridge for superior print quality. With the tri-color and photo print cartridges installed, you have a six-ink system. See **work with print cartridges** on page 32 for more information.

- 1 Place the completed proof sheet face down on the left front corner of the glass with the top of the sheet touching the left edge, and then close the lid.

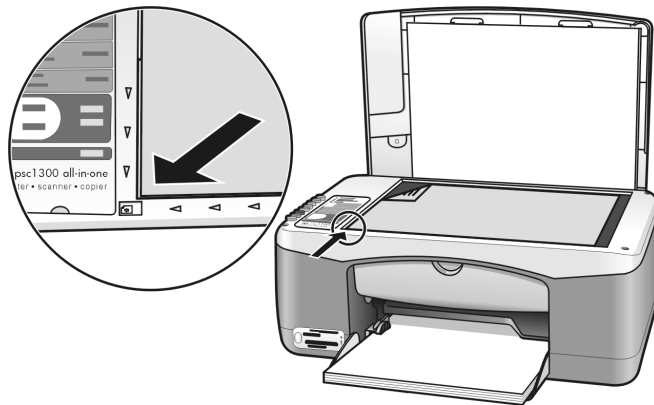

- 2 Load the appropriate paper, such as photo paper, in the paper tray. Make sure the memory card you used when you printed the proof sheet is still inserted in the HP PSC and that the **Photo** button is lit.

**Note:** If you use an old proof sheet and photos have been deleted from the memory card since the proof sheet was printed, it will not be possible to print those photos.

**3** Press the **Photo** button.

The HP PSC scans the proof sheet and prints the photos you selected, using the paper type and layout indicated on the sheet.

**Tip:** If you want to view your photos instead of printing them, try using the Slide Show feature available through the HP Photo & Imaging Gallery component of the HP Photo and Imaging Director (HP Director). This is a fast way to see all the files you've transferred from an inserted memory card to your computer.

**Tip:** The Macintosh version of the HP Gallery does not have a Slide Show feature, but you can create a multimedia slide show-like presentation if you have a writable CD drive by using the Memories Disc feature. For information on using Memories Disc, see the onscreen **hp photo and imaging help** that came with your software.

### create borderless prints

An exceptional feature of your HP PSC is its ability to turn the digital photos on a memory card into professional, borderless prints.

- 1** Insert the memory card into the appropriate slot on your HP PSC. Make sure the paper tray contains letter or A4 paper; otherwise the proof sheet does not print.
- 2** Press the **Photo** button to print a proof sheet. See **print a proof sheet** on page 20 for details.
- 3** Remove the proof sheet from the HP PSC.
- 4** Select photos on the proof sheet you want as borderless prints by filling in the circles under the photos. See **complete the proof sheet** on page 20 for more information.
- 5** Fill in the circle for small paper 4 by 6 inch (10 by 15 cm) in the bottom right area of the proof sheet. Do not select any other layout or paper type.
- 6** Place the completed proof sheet correctly on the glass.
- 7** Load 4 by 6 inch (10 by 15 cm) tabbed photo paper print side down in the paper tray, with the tab facing out towards you.
- 8** Press the **Photo** button to scan the proof sheet. The selected photos are printed as borderless prints. See **print photos by scanning a proof sheet** on page 21 for details.

**Tip:** You can enhance and edit digital photos with the HP Image Editor available through the HP Director. Just start the HP Director and click HP Gallery. Select the photo you want to edit, and click Image Editor in the top pane. Add text or special effects to the photo, improve a poor quality photo, or get rid of red eye.

**Tip:** On a Macintosh double-click the image in the HP Gallery and edit it in an Image Window. For information on editing images, see the onscreen **hp photo and imaging help** that came with your software.

## use the hp photo & imaging gallery

You can use the HP Gallery for viewing and editing image files. You can print images or send images by e-mail to family and friends, upload images to a website, or use images in fun and creative printing projects with the HP Gallery. HP software lets you do all this and much more. Explore the software to take full advantage of the features of your HP PSC.

**Tip:** Did you know you can e-mail any photo transferred to your computer from the HP PSC right in the HP Gallery? This makes it easy to share your digital masterpieces with family and friends.

If you want to open the HP Gallery at a later time, open the HP Director and click the HP Gallery icon.

On a Macintosh, if you want to open the HP Gallery at a later time, open the HP Director and click HP Gallery (OS 9) or click HP Director in the Dock and select HP Gallery from the Manage and Share section of the HP Director menu (OS X).



# 4

## use the copy features

The HP PSC enables you to produce high-quality color and black-and-white copies on plain paper. You can enlarge or reduce the size of an original to fit a specific paper size, including 4 by 6 inch (10 by 15 cm) photo paper.

This section contains the following topics:

- **make copies** on page 25
- **perform special copy jobs** on page 26
- **stop copying** on page 28

### make copies

You can make copies by using the front panel of your HP PSC or by using the HP Photo & Imaging Director (HP Director) software on your computer. Copy features are available through either method. However, the software offers additional copy features that are not available from the front panel.

All copy settings that you select on the front panel are reset *two minutes* after the HP PSC completes the copy.

This section contains the following topics:

- **make a copy** on page 25
- **adjust copy speed or quality** on page 26
- **set the number of copies** on page 26

#### make a copy

- 1 Load your original face down on the left front corner of the glass.  
If you are copying a photo, position the photo on the glass so the long edge of the photo is along the front edge of the glass. For more information, see **load originals** on page 11.

- 2 Press **Start Copy, Black** or **Start Copy, Color**.

The HP PSC makes an exact copy of your original using Best quality mode.

**Tip:** You can also use the Paper Type and Scan buttons to make Fast draft-quality copies or you can use the Size button to reduce or enlarge an original to fit a specific paper size.

For more information on these options, see the following topics:

- **adjust copy speed or quality** on page 26
- **reduce or enlarge an original to fit the paper loaded** on page 27

## adjust copy speed or quality

The HP PSC automatically copies in Best mode. This produces the highest quality copies for all paper. However, you can manually override this setting to copy in Fast mode. This produces copies more quickly and saves ink. The text is of comparable quality to copies produced using Best mode, but the graphics might be of lower quality.

### to make a copy from the front panel using the fast setting

- 1 Load your original face down on the left front corner of the glass.
- 2 Press the **Paper Type** button to select **Plain**.  
**Note:** In order to make a copy using Fast mode, you must select Plain as the Paper Type. If the Paper Type is set to Photo, the HP PSC will always copy in Best mode.
- 3 Press and hold down the **Scan** button, and then press **Start Copy, Black** or **Start Copy, Color**.

### set the number of copies

- 1 Load your original face down on the left front corner of the glass.
- 2 Press **Copies** to increase the number of copies, up to a maximum of 9, and then press **Start Copy, Black** or **Start Copy, Color**.

## perform special copy jobs

In addition to standard copying, your HP PSC can copy photos and automatically enlarge or reduce your original to fit a specific paper size.

This section contains the following topics:

- **make a 4 by 6 inch (10 by 15 cm) borderless copy of a photo** on page 26
- **reduce or enlarge an original to fit the paper loaded** on page 27

For information on copy options that are available in the HP Director, see the onscreen **hp photo & imaging help** that came with your software.

### make a 4 by 6 inch (10 by 15 cm) borderless copy of a photo

For the best quality when copying a photo, load photo paper in the paper tray, and then use the Paper Type button to select Photo. You might also want to use the photo print cartridge for superior print quality. With the tri-color and photo print cartridges installed, you have a six-ink system. See **use a photo print cartridge** on page 36 for more information.

- 1 Load your original photo face down on the left front corner of the glass.  
Position the photo on the glass so the long edge of the photo is along the front edge of the glass.



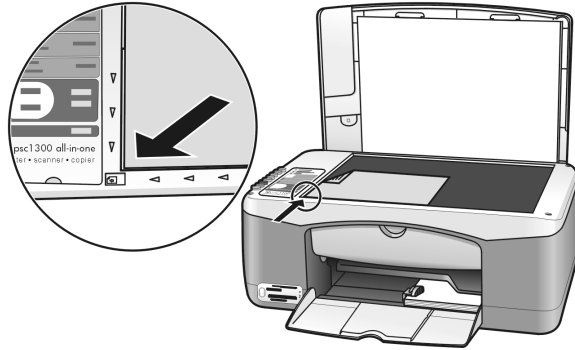

- 2 Load 4 by 6 inch (10 by 15 cm) tabbed photo paper print side down in the paper tray, with the tab facing out towards you.
- 3 If your original is not 4 by 6 inches (10 by 15 cm), press the **Size** button to select **Fit to Page**.  
The HP PSC will resize the original to 4 by 6 inches (10 by 15 cm) to create a borderless copy.
- 4 Press the **Paper Type** button to select **Photo**.  
This tells the HP PSC that you have photo paper loaded in the paper tray. When printing onto photo paper, the HP PSC automatically copies your original in Best quality mode.
- 5 Press **Start Copy, Black** or **Start Copy, Color**.

### reduce or enlarge an original to fit the paper loaded

Use Fit to Page when you want to automatically enlarge or reduce your original to fill the printable area of the paper size loaded in the paper tray.

For example, you can use Fit to Page to enlarge a small photo to fit within the margins of a full-size page (as shown below), reduce an original to prevent unwanted cropping of text or images around the margins, or reduce or enlarge an original to create a borderless 4 by 6 inch (10 by 15 cm) photo.

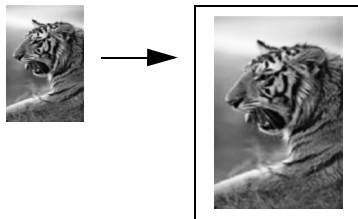

- 1 Make sure that the glass and lid backing are clean.
- 2 Load your original face down on the left front corner of the glass.  
If you are copying a photo, position the photo on the glass so the long edge of the photo is along the front edge of the glass, as shown below.

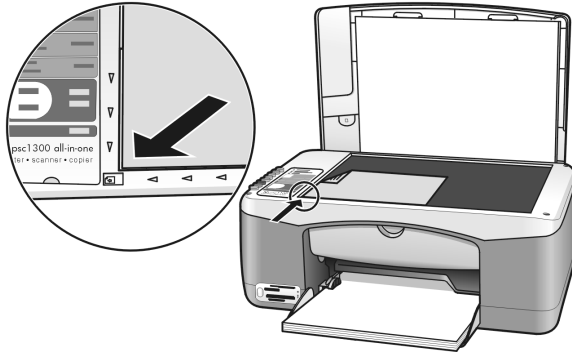

- 3 Press the **Size** button to select **Fit to Page**.
- 4 Press **Start Copy, Black** or **Start Copy, Color**.

## stop copying

- To stop copying, press **Cancel** on the front panel.  
The HP PSC immediately stops printing and releases the paper.

# 5

## use the scan features

Scanning is the process of converting pictures and text into an electronic format for your computer. You can scan photos and text documents.

Because the scanned image or text is in an electronic format, you can bring it into your word processor or graphics software program and modify it to suit your needs. You can do the following:

- Scan photos of your kids and e-mail them to relatives, create a photographic inventory of your house or office, or create an electronic scrapbook.
- Scan text from an article into your word processor and quote it in a report, saving you a lot of retyping.

To use the scan features, your HP PSC and computer must be connected and turned on. The HP PSC software must also be installed and running on your computer prior to scanning. To verify that the HP PSC software is running on a Windows PC, look for the hp psc 1300 series icon in the system tray at the lower right side of your screen, next to the time. On a Macintosh, the HP PSC software is always running.

You can start a scan from your computer or from your HP PSC. This section explains how to scan from the front panel of the HP PSC only.

For information about how to scan from the computer, and how to adjust, resize, rotate, crop, and sharpen your scans, see the onscreen **hp photo & imaging help** that came with your software.

**Note:** Bright direct sunlight on your HP PSC, or halogen desk lamps placed close to your HP PSC, might affect the quality of scanned images.

**Note:** High resolution scanning (600 dpi or higher) requires a large amount of hard disk space. If there is not enough hard disk space available, your system might stall.

This section contains the following topics:

- **scan an original** on page 29
- **stop scanning** on page 30

### scan an original

- 1 Load your original face down in the left front corner of the glass.
- 2 Press **Scan**.

A preview image of the scan appears in the HP Scan window on the computer, where you can edit it.

For more information about editing a preview image, see the onscreen **hp photo & imaging help** that came with your software.

- 3 Make any edits to the preview image in the **HP Scan** window. When you have finished, click **Accept**.

The HP PSC sends the scan to the HP Photo & Imaging Gallery (HP Gallery), which automatically opens and displays the image.

The HP Gallery has many tools that you can use to edit your scanned image. You can improve the overall image quality by adjusting the brightness, sharpness, color tone, or saturation. You can also crop, straighten, rotate, or resize the image.

When the scanned image looks just the way you want it, you can open it in another application, send it via e-mail, save it to a file, or print it. For more information about using the HP Gallery, see the onscreen **hp photo & imaging help** that came with your software.

## stop scanning

- To stop scanning, press **Cancel** on the front panel.

# 6

## maintain your hp psc

The HP PSC requires little maintenance. Sometimes you might want to clean the glass and lid backing to remove surface dust and ensure that your copies and scans remain clear. You might also want to replace, align, or clean your print cartridges from time to time. This section provides instructions for keeping your HP PSC in top working condition. Perform these simple maintenance procedures as necessary.

This section contains the following topics:

- **clean the glass** on page 31
- **clean the lid backing** on page 31
- **clean the exterior** on page 32
- **work with print cartridges** on page 32
- **self-maintenance sounds** on page 40

### clean the glass

Dirty glass from fingerprints, smudges, hair, and so on slows down performance and affects the accuracy of features such as Fit to Page.

- 1 Turn off the HP PSC, unplug the power cord, and raise the lid.
- 2 Clean the glass with a soft cloth or sponge slightly moistened with a nonabrasive glass cleaner.

**Caution!** Do not use abrasives, acetone, benzene, or carbon tetrachloride on the glass; these can damage it. Do not place or spray liquids directly on the glass. They might seep under it and damage the HP PSC.

- 3 Dry the glass with a chamois or cellulose sponge to prevent spotting.

### clean the lid backing

Minor debris can accumulate on the white document backing located underneath the lid of the HP PSC. This can cause problems during scan or copy tasks.

- 1 Turn off the HP PSC, unplug the power cord, and raise the lid.
- 2 Clean the white document backing with a soft cloth or sponge slightly moistened with a mild soap and warm water.
- 3 Wash the backing gently to loosen debris; do not scrub the backing.

- 4 Dry the backing with a chamois or soft cloth.  
**Caution!** Do not use paper-based wipes as these might scratch the backing.
- 5 If this does not clean the backing well enough, repeat the previous steps using isopropyl (rubbing) alcohol, and wipe the backing thoroughly with a damp cloth to remove any residual alcohol.

## clean the exterior

Use a soft cloth or slightly moistened sponge to wipe dust, smudges, and stains off the case. The interior of the HP PSC does not require cleaning. Keep fluids away from the interior of the HP PSC as well as the front panel.

## work with print cartridges

To ensure the best print quality from your HP PSC, you will need to perform some simple maintenance procedures.

This section contains the following topics:

- **check the ink levels** on page 32
- **print a self-test report** on page 33
- **handle print cartridges** on page 33
- **replace the print cartridges** on page 34
- **use a photo print cartridge** on page 36
- **use a print cartridge protector** on page 36
- **align the print cartridges** on page 37
- **clean the print cartridge contacts** on page 39

### check the ink levels

You can easily check the ink supply level to determine how soon you might need to replace a print cartridge. The ink level supply shows an approximation of the amount of ink remaining in the print cartridges. Checking the ink levels can only be done from the HP Photo & Imaging Director (HP Director).

#### to check the ink level for Windows users

- 1 From the **HP Director**, choose **Settings**, choose **Print Settings**, and then choose **Printer Toolbox**.
- 2 Click the **Estimated Ink Levels** tab.  
The estimated ink levels appear for the print cartridges.

#### to check the ink level for Macintosh users

- 1 From the **HP Director**, choose **Settings**, and then choose **Maintain Printer**.
- 2 If the **Select Printer** dialog box opens, select your HP PSC, and then click **Utilities**.
- 3 From the list, select **Ink Level**.  
The estimated ink levels appear for the print cartridges.

## print a self-test report

If you are experiencing problems with printing, print a Self-Test Report before you replace the print cartridges.

- 1 Press and hold down **Cancel**.
- 2 Press **Start Copy, Color**.

The HP PSC prints a Self-Test Report, which might indicate the source of any problems you might be having.

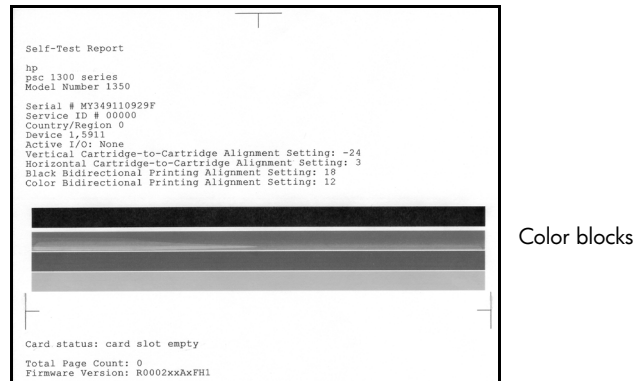

- 3 Check the color blocks for streaking or white lines.
  - Missing color blocks might indicate that the tri-color print cartridge is out of ink. You might need to clean or replace your print cartridges.
  - Streaks might indicate clogged nozzles or dirty contacts. You might need to clean the print cartridges. Do *not* clean with alcohol.

For information on replacing ink cartridges, see **replace the print cartridges** on page 34 and for information on cleaning print cartridges, see **clean the print cartridge contacts** on page 39.

## handle print cartridges

Before you replace a print cartridge, you should know the part names and how to handle the print cartridge.

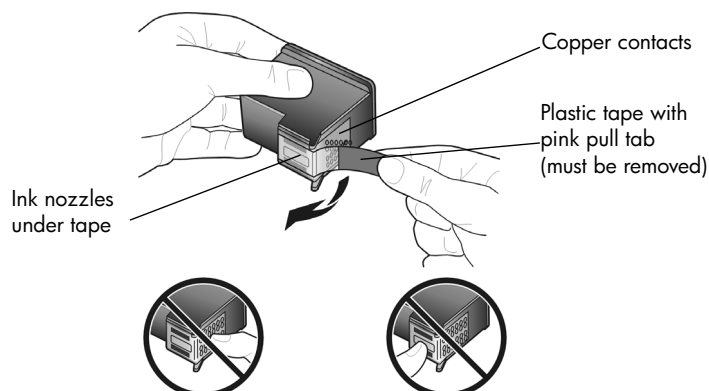

Do not touch the copper contacts or the ink nozzles

## replace the print cartridges

The HP PSC notifies you when you need to replace your print cartridges. Replace the print cartridges when you see faded text or if you experience print quality issues related to the print cartridges.

For more information on ordering replacement print cartridges, see **order print cartridges** on the inside back cover.

- 1 Turn on the HP PSC and then lower the paper tray to access the print-carriage access door.
- 2 Open the print-carriage access door by lowering the handle. The print carriage moves to the center of the HP PSC.

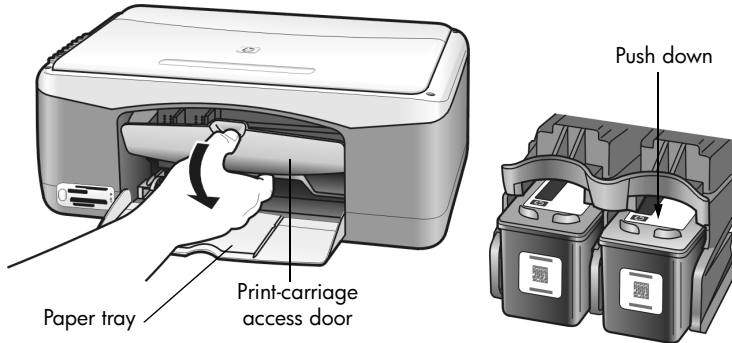

- 3 After the carriage stops moving, push down on the print cartridge to release it, and then pull it toward you out of its slot.

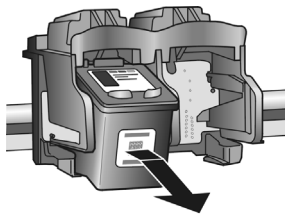

**Note:** It is normal to see ink buildup in the print cartridge slots.

- 4 Remove the new print cartridge from its packaging and, being careful to touch only the bright pink plastic tab, gently remove the plastic tape to uncover the ink nozzles.

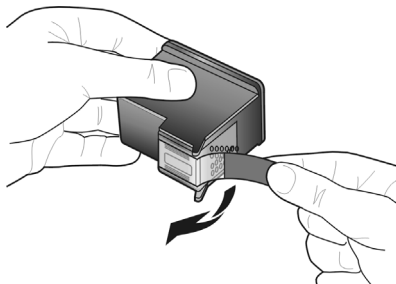

**Caution!** Do not touch the copper contacts or ink nozzles.



After you have removed the plastic tape, install the print cartridge immediately to prevent the ink from drying in the nozzles.

- 5 Hold the black print cartridge with the HP label on top. Slide the print cartridge at a slight angle into the *right* side of the print carriage. Press firmly until the print cartridge snaps into place.

**Caution!** Do not attempt to push the cartridge straight into the slot. It must slide in at a slight angle.

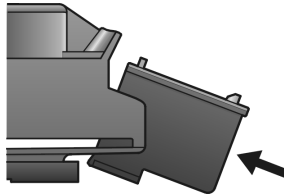

- 6 Hold the tri-color print cartridge with the HP label on top. Slide the print cartridge at a slight angle into the *left* side of the print carriage. Press firmly until the print cartridge snaps into place.

**Caution!** Do not attempt to push the cartridge straight into the slot. It must slide in at a slight angle.

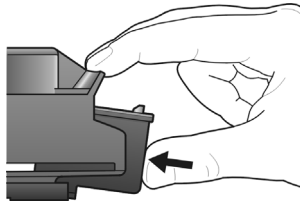

**Note:** You must install *both* print cartridges in order for your HP PSC to work.

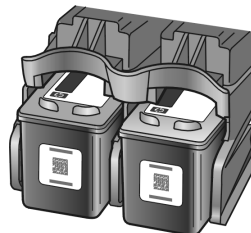

You can also refer to the label that is located on the inside of the print-carriage access door for information on installing the print cartridges.

- 7 Close the print-carriage access door. Within a few minutes, a print cartridge alignment page prints. You will need to align the print cartridges.

For information on aligning the print cartridges, see **align the print cartridges** on page 37.

## use a photo print cartridge

You can optimize the quality of the photos you print with your HP PSC by purchasing a photo print cartridge. Remove the black print cartridge and insert the photo print cartridge in its place. With the tri-color print cartridge and photo print cartridge installed, you have a six-ink system, which provides enhanced quality photos. When you want to print regular text documents, swap the black print cartridge back in. Use a print cartridge protector to keep your print cartridge secure when it is not being used. For more information on using the print cartridge protector, see **use a print cartridge protector** on page 36 and for more information on replacing print cartridges, see **replace the print cartridges** on page 34.

For more information on purchasing a photo print cartridge, see **order print cartridges** on the inside back cover.

## use a print cartridge protector

When you purchase a photo print cartridge, you will receive a print cartridge protector.

The print cartridge protector is designed to keep your print cartridge secure when it is not being used. It also prevents the ink from drying out. Whenever you remove a print cartridge from the HP PSC, store it in the print cartridge protector.

- ➔ To insert a print cartridge into the print cartridge protector, slide the print cartridge into the print cartridge protector at a slight angle and snap it securely into place.

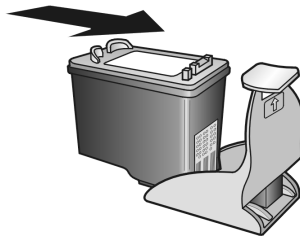

- ➔ To remove the print cartridge from the print cartridge protector, press down and back on the top of the print cartridge protector to release the print cartridge, then slide the print cartridge out of the print cartridge protector.

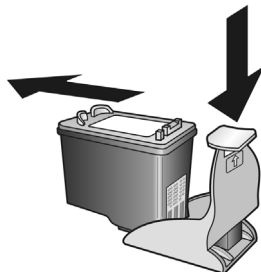

## align the print cartridges

After you install or replace a print cartridge, the HP PSC automatically prints a print cartridge alignment sheet. This might take a few moments. You can also align the print cartridges at any time from the HP Director. For information on accessing the HP Director, see **use your hp psc with a computer** on page 6. Aligning the print cartridges ensures high-quality output.

### to align the print cartridges after installing a new print cartridge

- 1 Place the print cartridge alignment sheet face down on the left front corner of the glass. Make sure the top of the sheet is on the left side as shown below.

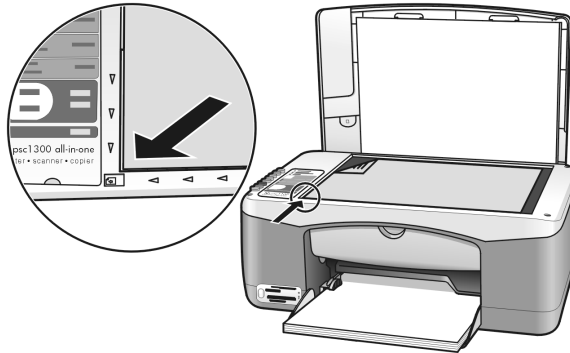

- 2 Press **Scan**.  
The HP PSC aligns the print cartridges.

**Note:** During alignment the button LED blinks until the procedure is finished. This takes about 30 seconds.

### to align the print cartridges from the hp director for Windows users

- 1 From the **HP Director**, choose **Settings**, choose **Print Settings**, and then choose **Printer Toolbox**.
- 2 Click the **Device Services** tab.
- 3 Click **Align the Print Cartridges**.  
A print cartridge alignment sheet is printed.

- 4 Place the print cartridge alignment sheet face down on the left front corner of the glass. Make sure the top of the sheet is on the left side as shown below.

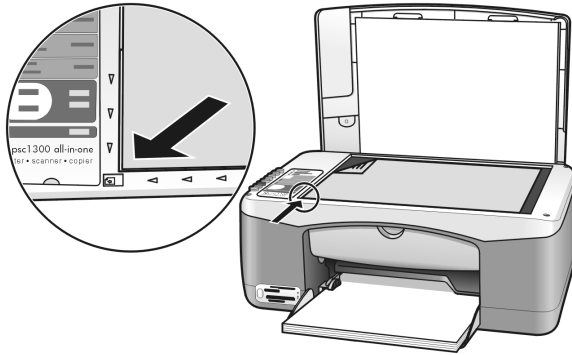

- 5 Press **Scan**.  
The HP PSC aligns the print cartridges.

**Note:** During alignment the button LED blinks until the procedure is finished. This takes about 30 seconds.

**to align the print cartridges from the hp director for Macintosh users**

- 1 From the **HP Director**, choose **Settings**, and then choose **Maintain Printer**.
- 2 If the **Select Printer** dialog box opens, select your HP PSC, and then click **Utilities**.
- 3 From the list, select **Calibrate**.
- 4 Click **Align**.  
The HP PSC prints a print cartridge alignment sheet. This might take a few moments.
- 5 Place the print cartridge alignment sheet face down on the left front corner of the glass. Make sure the top of the sheet is on the left side.

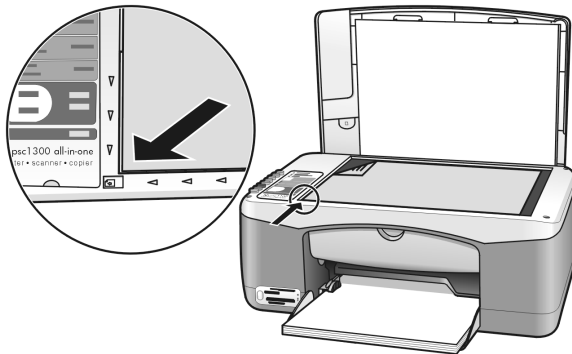

- 6 Press **Scan**.  
The HP PSC aligns the print cartridges.

**Note:** During alignment the button LED blinks until the procedure is finished. This takes about 30 seconds.

## clean the print cartridge contacts

Clean the print cartridge contacts only if the Self-Test Report shows streaks.

**Caution!** Do not remove both print cartridges at the same time. Remove and clean each print cartridge one at a time.

Make sure you have the following materials available:

- Dry foam rubber swabs, lint-free cloth, or any soft material that will not come apart or leave fibers.
- Distilled, filtered, or bottled water (tap water might contain contaminants that can damage the print cartridges).

**Caution!** Do *not* use platen cleaners or alcohol to clean the print cartridge contacts. These can damage the print cartridge or the HP PSC.

- 1 Turn the HP PSC on and open the print-carriage access door. The print carriage moves to the center.
- 2 After the print carriage has moved to the center, unplug the power cord from the back of the HP PSC.
- 3 Push down on the print cartridge to release it, and then pull it out of its slot.
- 4 Inspect the print cartridge contacts for ink and debris buildup.
- 5 Dip a clean foam rubber swab or lint-free cloth into distilled water, and squeeze any excess water from it.
- 6 Hold the print cartridge by its sides.
- 7 Clean only the contacts. Do *not* clean the nozzles.

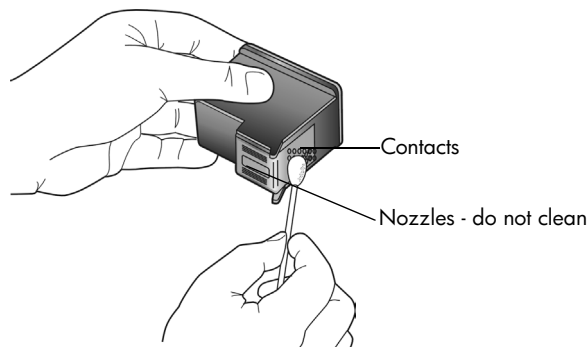

- 8 Place the print cartridge back into the holder.
- 9 Repeat if necessary for the other print cartridge.
- 10 Close the door and plug in the HP PSC.  
Because you removed a print cartridge from its holder, the HP PSC automatically prints a print cartridge alignment sheet.

- 11 Place the print cartridge alignment sheet face down on the left front corner of the glass. Make sure the top of the sheet is on the left side as shown below.

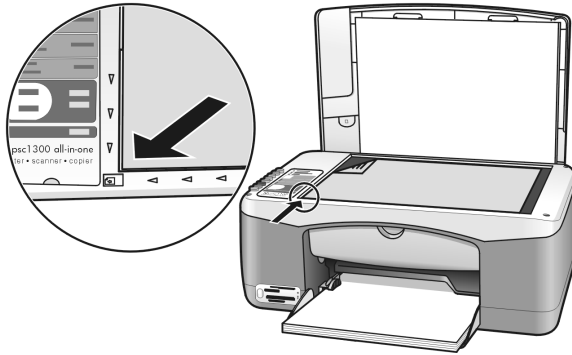

- 12 Press **Scan**.

The HP PSC aligns the print cartridges.

**Note:** During alignment the button LED blinks until the procedure completes. This takes about 30 seconds.

## self-maintenance sounds

During the life of your product you might hear various mechanical sounds. This is a normal part of your device's self-maintenance.

# 7

## get hp psc 1300 series support

Hewlett-Packard provides Internet and phone support for your HP PSC.

This section contains the following topics:

- **get support and other information from the Internet** on page 41
- **hp customer support** on page 41
- **prepare your hp psc for shipment** on page 44
- **hp distribution center** on page 45

If you are unable to find the answer you need in the printed or onscreen documentation supplied with your product, you can contact one of the HP support services listed in the following sections. Some support services are available only in the U.S. and Canada, while others are available in many countries/regions worldwide. If a support service number is not listed for your country/region, contact your nearest authorized HP dealer for help.

### get support and other information from the Internet

If you have Internet access, you can get more information from the HP website at:

**[www.hp.com/support](http://www.hp.com/support)**

This website offers technical support, drivers, supplies, and ordering information.

### hp customer support

Software programs from other companies might be included with your HP PSC. If you experience problems with any of those programs, you will receive the best technical assistance by calling the experts at that company.

If you need to contact HP Customer Support, do the following before you call.

- 1 Make sure that:
  - a. Your HP PSC is plugged in and turned on.
  - b. The specified print cartridges are installed correctly.
  - c. The recommended paper is properly loaded in the paper tray.
- 2 Reset your HP PSC:
  - a. Turn off the HP PSC by using the **On/Resume** button located on the front panel.
  - b. Unplug the power cord from the back of the HP PSC.
  - c. Plug the power cord back into the device.
  - d. Turn on the HP PSC by using the **On/Resume** button.
- 3 For more information, go to the HP website at:  
**[www.hp.com/support](http://www.hp.com/support)**
- 4 If you are still experiencing problems and need to speak with an HP Customer Support Representative:
  - Have the specific name of your HP PSC, as it appears on the device, available.
  - Have your serial number and service ID ready. To view your serial number and service ID, print a Self-Test Report, which contains this information. To print a Self-Test Report, press and hold the **Cancel** button, and then press the **Start Copy, Color** button.
  - Be prepared to describe your problem in detail.
- 5 Call HP Customer Support. Be near your HP PSC when you call.

## call in North America during warranty

Call 1-800-HP-INVENT. US phone support is available in both English and Spanish languages 24 hours a day, 7 days a week (days and hours of support might change without notice). This service is free during the warranty period. A fee might apply outside the warranty period.

## call hp japan customer support

カスタマケアセンター 連絡先

TEL : 0570-000511 (携帯電話・PHS からは: 03-3335-9800 )  
FAX : 03-3335-8338

- ・電話番号受付時間: 平日 9:00 ~17:00  
土曜日/日曜日 10:00 ~17:00  
(祝祭日、1月1日~3日を除く)

- ・FAX によるお問い合わせは、ご質問内容とともに、ご連絡先、弊社製品名、接続コンピュータ名をご記入ください。

## call elsewhere in the world

The numbers listed below are current as of the publication date of this guide. For a list of current international HP Support Service numbers, go to the following website and choose your own country/region or language:

### [www.hp.com/support](http://www.hp.com/support)

You can call the HP support center in the following countries/regions. If your country/region is not listed, contact your local dealer or nearest HP Sales and Support Office to find out how to obtain services.

Support service is free during the warranty period; however, your standard long-distance phone charges will apply. In some cases, a flat fee per single incident will also apply.

For phone support in Europe, please check for the details and conditions of phone support in your country/region. Go to the following website:

### [www.hp.com/support](http://www.hp.com/support)

Alternatively, you can ask your dealer or call HP at the phone number provided in this booklet.

As part of our constant efforts to improve our phone support service, we advise you to check our website on a regular basis for new information regarding service features and delivery.

country/region	hp technical support	country/region	hp technical support
Algeria <sup>1</sup>	+213(0)61 56 45 43	Luxembourg (French)	900 40 006
Argentina	(54)11-4778-8380 0-810-555-5520	Luxembourg (German)	900 40 007
Australia	+61 3 8877 8000 1902 910 910	Malaysia	1-800-805405
Austria	+43 (0) 820 87 4417	Mexico	01-800-472-6684
Bahrain (Dubai)	+973 800 728	Mexico (Mexico City)	5258-9922
Belgium (Dutch)	+32 (0) 70 300 005	Morocco <sup>1</sup>	+212 224 047 47
Belgium (French)	+32 (0) 70 300 004	Netherlands (0.10 Euro/ min.)	0900 2020 165



country/region	hp technical support	country/region	hp technical support
Bolivia	800-100247	New Zealand	0800 441 147
Brazil (Grande São Paulo)	(11) 3747 7799	Norway	+47 815 62 070
Brazil (Demais Localidades)	0800 157751	Oman	+971 4 883 8454
Canada during warranty	(905) 206 4663	Palestine	+971 4 883 8454
Canada post-warranty (per-call charge)	1-877-621-4722	Panama	001-800-7112884
Caribbean & Central America	1-800-711-2884	Peru	0-800-10111
Chile	800-360-999	Philippines	632-867-3551
China	86-21-38814518 8008206616	Poland	+48 22 865 98 00
Colombia	9-800-114-726	Portugal	+351 808 201 492
Costa Rica	0-800-011-0524	Puerto Rico	1-877-232-0589
Czech Republic	+42 (0) 2 6130 7310	Qatar	+971 4 883 8454
Denmark	+45 70202845	Romania	+40 1 315 44 42
Ecuador (Andinatel)	999119+1-800-7112884	Russia, Moscow	+7 095 797 3520
Ecuador (Pacifitel)	1-800-225528+1-800-7112884	Russia, St. Petersburg	+7 812 346 7997
Europe (English)	+44 (0) 207 512 5202	Saudi Arabia	+966 800 897 1444
Egypt	+20 02 532 5222	Singapore	(65) 272-5300
Finland	+358 (0) 203 66 767	Slovakia	+ 421 2 6820 8080
France (0.34 Euro/min.)	+33 (0) 892 6960 22	South Africa (RSA)	086 000 1030
Germany (0.12 Euro/min.)	+49 (0) 180 5652 180	South Africa, Outside Republic	+27-11 258 9301
Greece	+30 10 6073 603	Spain	+34 902 010 059
Hong Kong	+85 (2) 3002 8555	Sweden	+46 (0)77 120 4765
Guatemala	1800-995-5105	Switzerland <sup>2</sup> (0.08 CHF/min. during peak hours, 0.04 CHF/min. during off-peak hours)	+41 (0) 848 672 672
Hungary	+36 (0) 1 382 1111	Taiwan	+886-22717-0055 0800 010 055
India	1-600-112267 91 11 682 6035	Thailand	+66 (2) 661 4000
Indonesia	62-21-350-3408	Tunisia <sup>1</sup>	+216 1 891 222
Ireland	+353 1890 923902	Turkey	+90 216 579 7171
Israel	+972 (0) 9 803 4848	Ukraine	+7 (380-44) 490-3520
Italy	+39 848 800 871	United Arab Emirates	+971 4 883 845
Japan	0570 000 511 +81 3 3335 9800	United Kingdom	+44 (0) 870 010 4320
Jordan	+971 4 883 8454	Venezuela	01-800-4746.8368

country/region	hp technical support	country/region	hp technical support
Korea	+82 1588 3003	Venezuela (Caracas)	(502) 207-8488
Kuwait	+971 4 883 8454	Vietnam	84-8-823-4530
Lebanon	+971 4 883 8454	Yemen	+971 4 883 8454

- 1 This Call Center supports French-speaking customers from the following countries/regions: Morocco, Tunisia, and Algeria.
- 2 This Call Center supports German-, French- and Italian-speaking customers in Switzerland.

### call in Australia post-warranty

If your product is not under warranty, you can call 03 8877 8000. A per-incident, out-of-warranty support fee of \$27.50 (inc. GST) will be charged to your credit card. You can also call 1902 910 910 (\$27.50 charged to your phone account) from 9:00 A.M. to 5:00 P.M. Monday through Friday. Charges and support hours are subject to change without notice.

## prepare your hp psc for shipment

If after contacting HP Customer Support or returning to the point of purchase, you are requested to send your HP PSC in for service, please follow the power off and re-package steps below to avoid further damage to the device.

**Note:** When transporting your HP PSC, make sure that the print cartridges have been removed, the HP PSC has been properly shut down by pressing the On/Resume button, and you have allowed time for the print carriage to return to the home position and for the scanner to return to its parked position.

- 1 Turn on the HP PSC.  
Disregard steps 1 through 7 if your HP PSC will not turn on. You will not be able to remove the print cartridges. Proceed to step 8.
- 2 Open the print-carriage access door.  
The print carriage moves to the center of the HP PSC.
- 3 Remove the print cartridges. See **replace the print cartridges** on page 34 for information on removing the print cartridges.  
**Caution!** Remove both print cartridges. Failure to do so might damage your HP PSC.
- 4 Place the print cartridges in an airtight bag so they will not dry out, and put them aside. Do not send them with the HP PSC, unless instructed to by the HP customer support call agent.
- 5 Close the print-carriage access door.
- 6 Wait for the print carriage to park (stop moving) in the home position on the left side of the HP PSC. This might take a few seconds.
- 7 Turn off the HP PSC.
- 8 If available, pack the HP PSC for shipment by using the original packing materials or the packaging materials that came with your exchange device.

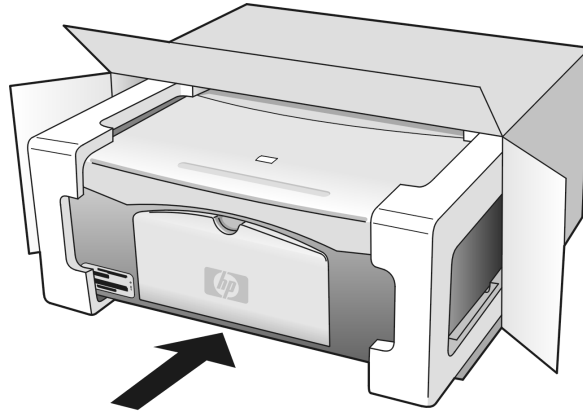

If you do not have the original packaging materials, please use other adequate packaging materials. Shipping damage caused by improper packaging and/or improper transportation is not covered under the warranty.

- 9 Place the return shipping label on the outside of the box.
- 10 Include the following items in the box:
  - A brief description of symptoms for service personnel (samples of print quality problems are helpful).
  - A copy of the sales slip or other proof of purchase to establish the warranty coverage period.
  - Your name, address, and a phone number where you can be reached during the day.

## hp distribution center

To order HP PSC software, a copy of the printed Reference Guide, a Setup Poster, or other customer-replaceable parts, do one of the following:

- In the U.S. or Canada, call 1-800-HP-INVENT (1-800-474-6836).
- In Latin America, call the appropriate number for your country/region (see **call elsewhere in the world** on page 42).
- Outside of this country/region, go to this website:  
**[www.hp.com/support](http://www.hp.com/support)**



# 8

## warranty information

Your HP PSC comes with a limited warranty that is described in this section. Information about how to obtain warranty service and how you can upgrade your standard factory warranty is also provided.

This section contains the following topics:

- **duration of limited warranty** on page 47
- **warranty service** on page 47
- **warranty upgrades** on page 47
- **returning your hp psc for service** on page 48
- **hewlett-packard limited global warranty statement** on page 48

### duration of limited warranty

Duration of Limited Warranty (hardware and labor): 1 Year

Duration of Limited Warranty (CD media): 90 Days

Duration of Limited Warranty (print cartridges): Until the HP ink is depleted or the “end of warranty” date printed on the cartridge has been reached, whichever occurs first.

**Note:** The services described in the **express service** and **warranty upgrades** sections below might not be available in all locations.

### warranty service

#### express service

To obtain HP express repair service, the customer must contact an HP service office or an HP Customer Support Center for basic troubleshooting first. See **hp customer support** on page 41 for steps to take before calling Customer Support.

If a customer device needs a minor part replacement and these parts can normally be replaced by the customer, the customer-replaceable components might be serviced through expedited part shipment. In this event, HP will prepay shipping charges, duty and taxes; provide telephone assistance on replacement of the component; and pay shipping charges, duty, and taxes for any part that HP asks to be returned.

The HP Customer Support Center might direct customers to designated authorized service providers who are certified by HP to service the HP product.

### warranty upgrades

Upgrade your standard factory warranty to a total of three years with the HP SUPPORTPACK. Service coverage begins on product purchase date and the pack must be purchased within the first 180 days after product purchase. If during your technical support call it is determined that you need a replacement product, then HP will ship you this product next business day free of charge. Available in U.S. only.

For more information, please call 1-888-999-4747 or visit the HP website:

**[www.hp.com/go/hpsupportpack](http://www.hp.com/go/hpsupportpack)**

Outside the U.S., please call your local HP Customer Support office. See **call elsewhere in the world** on page 42 for a list of international Customer Support numbers.

## returning your hp psc for service

Before returning your HP PSC for service, you must call HP Customer Support. See **hp customer support** on page 41 for steps to take before calling Customer Support.

## hewlett-packard limited global warranty statement

### extent of limited warranty

Hewlett-Packard ("HP") warrants to the end-user customer ("Customer") that each HP PSC product ("Product"), including related software, accessories, media, and supplies, shall be free from defects in material and workmanship for the duration, which begins on the date of purchase by the Customer.

For each software Product, HP's limited warranty applies only to a failure to execute programming instructions. HP does not warrant that the operation of any Product shall be uninterrupted or error free.

HP's limited warranty covers only those defects which arise as a result of normal use of a Product, and does not cover any other problems, including those which arise as a result of (a) improper maintenance or modification, (b) software, accessories, media, or supplies not provided or supported by HP, or (c) operation outside the Product's specifications.

For any hardware Product, the use of a non-HP print cartridge or a refilled print cartridge does not affect either the warranty to the Customer or any HP support contract with the Customer. However, if Product failure or damage is attributable to the use of a non-HP or refilled print cartridge, HP shall charge its standard labor and materials charges to service the Product for the failure or damage.

If HP receives, during the applicable warranty period, notice of a defect in any Product, HP shall either repair or replace the defective Product, at HP's option. Where labor charges are not covered by HP's limited warranty, repairs shall be at HP's standard charges for labor.

If HP is unable to repair or replace, as applicable, a defective Product which is covered by HP's warranty, HP shall, within a reasonable time after being notified of the defect, refund the purchase price for the Product.

HP shall have no obligation to repair, replace, or refund until the Customer returns the defective Product to HP.

Any replacement product may be either new or like-new, provided that it has functionality at least equal to that of the Product being replaced.

HP products, including each Product, may contain remanufactured parts, components, or materials equivalent to new in performance.

HP's limited warranty for each Product is valid in any country/region or locality where HP has a support presence for the Product and where HP has marketed the Product. The level of warranty service may vary according to local standards. HP shall have no obligation to alter the form, fit, or function of the Product in order to make it operate in a country/region or locality for which the Product was never intended to operate.

### limitations of warranty

TO THE EXTENT ALLOWED BY LOCAL LAW, NEITHER HP NOR ITS THIRD PARTY SUPPLIERS MAKE ANY OTHER WARRANTY OR CONDITION OF ANY KIND, WHETHER EXPRESS OR IMPLIED, WITH RESPECT TO THE COVERED HP PRODUCTS, AND SPECIFICALLY DISCLAIM THE IMPLIED WARRANTIES OR CONDITIONS OF MERCHANTABILITY, SATISFACTORY QUALITY, AND FITNESS FOR A PARTICULAR PURPOSE.

## limitations of liability

To the extent allowed by local law, the remedies provided in this Limited Warranty Statement are the Customer's sole and exclusive remedies.

TO THE EXTENT ALLOWED BY LOCAL LAW, EXCEPT FOR THE OBLIGATIONS SPECIFICALLY SET FORTH IN THIS LIMITED WARRANTY STATEMENT, IN NO EVENT SHALL HP OR ITS THIRD PARTY SUPPLIERS BE LIABLE FOR DIRECT, INDIRECT, SPECIAL, INCIDENTAL, OR CONSEQUENTIAL DAMAGES, WHETHER BASED ON CONTRACT, TORT, OR ANY OTHER LEGAL THEORY AND WHETHER ADVISED OF THE POSSIBILITY OF SUCH DAMAGES.

## local law

This Limited Warranty Statement gives the Customer specific legal rights. The Customer may also have other rights which vary from state to state in the United States, from province to province in Canada, and from country/region to country/region elsewhere in the world.

To the extent this Limited Warranty Statement is inconsistent with local law, this Statement shall be deemed modified to be consistent with such local law. Under such local law, certain disclaimers and limitations of this Statement may not apply to the Customer. For example, some states in the United States, as well as some governments outside the United States (including provinces in Canada), may:

Preclude the disclaimers and limitations in this Statement from limiting the statutory rights of a consumer (e.g. the United Kingdom);

Otherwise restrict the ability of a manufacturer to enforce such disclaimers or limitations; or

Grant the Customer additional warranty rights, specify the duration of implied warranties which the manufacturer cannot disclaim, or not allow limitations on the duration of implied warranties.

FOR CONSUMER TRANSACTIONS IN AUSTRALIA AND NEW ZEALAND, THE TERMS IN THIS LIMITED WARRANTY STATEMENT, EXCEPT TO THE EXTENT LAWFULLY PERMITTED, DO NOT EXCLUDE, RESTRICT, OR MODIFY, AND ARE IN ADDITION TO, THE MANDATORY STATUTORY RIGHTS APPLICABLE TO THE SALE OF THE COVERED HP PRODUCTS TO SUCH CUSTOMERS.





The technical specifications for your HP PSC are provided in this section. Also, international regulatory information for your HP PSC is supplied in this section. This section contains the following information:

- **paper specifications** on page 51
- **photo memory card specifications** on page 52
- **power specifications** on page 52
- **physical specifications** on page 52
- **environmental specifications** on page 52
- **environmental product stewardship program** on page 53
- **regulatory notices** on page 54

## paper specifications

### paper-tray capacity

type	paper weight	quantity <sup>1</sup>
Plain paper	20 to 24 lb. (75 to 90 gsm)	100
Legal paper	20 to 24 lb. (75 to 90 gsm)	100
Cards	110 lb. index max (200 gsm)	20
Envelopes	20 to 24 lb. (75 to 90 gsm)	10
Transparency film	N/A	20
Labels	N/A	20
4 by 6 inch (10 by 15 cm) Photo	145 lb. (236 gsm)	20

<sup>1</sup> Maximum capacity

### print margin specifications

	top (leading edge)	bottom (trailing edge) <sup>1</sup>	left	right
<b>sheet paper or transparency film</b>				
U.S. (Letter, Legal)	.06 inch (1.5 mm)	.50 inch (12.7 mm)	.25 inch (6.4 mm)	.25 inch (6.4 mm)
ISO (A4)	.07 inch (1.8 mm)	.50 inch (12.7 mm)	.13 inch (3.2 mm)	.13 inch (3.2 mm)
Envelopes	.13 inch (3.2 mm)	.13 inch (3.2 mm)	.25 inch (6.4 mm)	.50 inch (12.7 mm)
Cards	.07 inch (1.8 mm)	.46 inch (11.7 mm)	.13 inch (3.2 mm)	.13 inch (3.2 mm)

<sup>1</sup> The writing area is offset from center by .21 inches (5.4 mm), which causes asymmetric top and bottom margins.

## photo memory card specifications

- Maximum recommended number of files on a memory card: 1,000
- Maximum recommended individual file size: 12 megapixels maximum, 8 MB maximum
- Maximum recommended memory card size: 1 GB (solid state only)

**Note:** Approaching any of the recommended maximums on a memory card might cause the performance of the HP PSC to be slower than expected.

### supported memory card types

---

CompactFlash

---

SmartMedia

---

Memory Stick

---

Memory Stick Duo

---

Memory Stick Pro

---

Secure Digital

---

MultiMediaCard (MMC)

---

xD-Picture Card

---

## physical specifications

- Height: 6.68 inch (16.97 cm)
- Width: 16.76 inch (42.57 cm)
- Depth: 10.20 inch (25.91 cm)
- Weight: 10 lb. (4.53 kg)

## power specifications

- Power consumption: 80 W maximum
- Input Voltage: AC 100 to 240 V ~ 1 A 50–60 Hz, grounded
- Output Voltage: DC 32 V===940 mA, 16 V===625 mA

## environmental specifications

- Recommended Operating Temperature Range: 15° to 32° C (59° to 90° F)
- Allowable Operating Temperature Range: 5° to 40° C (41° to 104° F)
- Humidity: 15% to 85% RH non-condensing
- Non-operating (Storage) Temperature Range: -4° to 60° C (-40° to 140° F)
- In the presence of high electromagnetic fields, it is possible the output from the HP PSC might be slightly distorted
- HP recommends using a USB cable less than or equal to 3 m (10 feet) in length to minimize injected noise due to potential high electromagnetic fields

## environmental product stewardship program

### protecting the environment

Hewlett-Packard is committed to providing quality products in an environmentally sound manner. This product has been designed with several attributes to minimize impacts on our environment.

For more information, visit HP's Commitment to the Environment website at:

[www.hp.com/hpinfo/globalcitizenship/environment/index.html](http://www.hp.com/hpinfo/globalcitizenship/environment/index.html)

### ozone production

This product generates no appreciable ozone gas (O<sub>3</sub>).

### energy consumption

Energy usage drops significantly while in ENERGY STAR® mode, which saves natural resources, and saves money without affecting the high performance of this product. This product qualifies for ENERGY STAR, which is a voluntary program established to encourage the development of energy-efficient office products.



ENERGY STAR is a U.S. registered service mark of the U.S. EPA. As an ENERGY STAR partner, HP has determined that this product meets ENERGY STAR guidelines for energy efficiency.

For more information on ENERGY STAR guidelines, see the following web site:

[www.energystar.gov](http://www.energystar.gov)

### paper use

This product is suited for the use of recycled paper according to DIN 19309.

### plastics

Plastic parts over 25 grams are marked according to international standards that enhance the ability to identify plastics for recycling purposes at the end of the product's life.

### material safety data sheets

Material safety data sheets (MSDS) can be obtained from the HP website at:

[www.hp.com/go/msds](http://www.hp.com/go/msds)

Customers without Internet access should contact their local HP Customer Support Center.

### recycling program

HP offers an increasing number of product return and recycling programs in many countries, and partners with some of the largest electronic recycling centers throughout the world. HP also conserves resources by refurbishing and reselling some of its most popular products.

This HP product contains the following materials that might require special handling at end-of-life:

- Lead in solder

## hp inkjet supplies recycling program

HP is committed to protecting the environment. The HP Inkjet Supplies Recycling Program is available in many countries/regions, and lets you recycle used print cartridges free of charge. For more information, see the following HP website:

[www.hp.com/hpinfo/globalcitizenship/environment/recycle/inkjet.html](http://www.hp.com/hpinfo/globalcitizenship/environment/recycle/inkjet.html)

## regulatory notices

The HP PSC is designed to meet the regulatory requirements for your country/region.

### regulatory model identification number

For regulatory identification purposes, your product is assigned a Regulatory Model Number. The Regulatory Model Number for your product is SDGOB-0303. This regulatory number should not be confused with the marketing name (HP PSC 1300 Series) or product numbers (Q3500A, Q5533A).

### FCC statement

The United States Federal Communications Commission (in 47 CFR 15.105) has specified that the following notice be brought to the attention of users of this product.

Declaration of Conformity: This equipment has been tested and found to comply with the limits for a Class B digital device, pursuant to part 15 of the FCC Rules. Operation is subject to the following two conditions: (1) this device may not cause harmful interference, and (2) this device must accept any interference received, including interference that may cause undesired operation. Class B limits are designed to provide reasonable protection against harmful interference in a residential installation. This equipment generates, uses, and can radiate radio frequency energy, and, if not installed and used in accordance with the instructions, may cause harmful interference to radio communications. However, there is no guarantee that interference will not occur in a particular installation. If this equipment does cause harmful interference to radio or television reception, which can be determined by turning the equipment off and on, the user is encouraged to try to correct the interference by one or more of the following measures:

- Reorient the receiving antenna.
- Increase the separation between the equipment and the receiver.
- Connect the equipment into an outlet on a circuit different from that to which the receiver is connected.
- Consult the dealer or an experienced radio/TV technician for help.

Product Regulations Manager, Hewlett-Packard Company, San Diego, (858) 655-4100.

The user may find the following booklet prepared by the Federal Communications Commission helpful: How to Identify and Resolve Radio-TV Interference Problems. This booklet is available from the U.S. Government Printing Office, Washington DC, 20402. Stock No. 004-000-00345-4.

**Caution!** Pursuant to Part 15.21 of the FCC Rules, any changes or modifications to this equipment not expressly approved by the Hewlett-Packard Company may cause harmful interference and void the FCC authorization to operate this equipment.

### note à l'attention des utilisateurs Canadien/notice to users in Canada

Le présent appareil numérique n'émet pas de bruit radioélectrique dépassant les limites applicables aux appareils numériques de la classe B prescrites dans le Règlement sur le brouillage radioélectrique édicté par le ministère des Communications du Canada.

This digital apparatus does not exceed the Class B limits for radio noise emissions from the digital apparatus set out in the Radio Interference Regulations of the Canadian Department of Communications.

**notice to users in Australia**

 This equipment complies with Australian EMC requirements

**geräuschemission**

LpA < 70 dB  
am Arbeitsplatz  
im Normalbetrieb  
nach DIN 45635 T. 19

**notice to users in Japan (VCCI-2)**

この装置は、情報処理装置等電波障害自主規制協議会（VCCI）の基準に基づくクラスB情報技術装置です。この装置は、家庭環境で使用することを目的としていますが、この装置がラジオやテレビジョン受信機に近接して使用されると受信障害を引き起こすことがあります。

取り扱い説明書に従って正しい取り扱いをして下さい。

**notice to users in Korea****사용자 안내문 (B급 기기)**

이 기기는 비업무용으로 전자파장해검정을 받은 기기로서, 주거지역에서는 물론 모든 지역에서 사용될 수 있습니다.

**declaration of conformity (European Union)**

The Declaration of Conformity in this document complies with ISO/IEC Guide 22 and EN45014. It identifies the product, manufacturer's name and address, and applicable specifications recognized in the European community.

## declaration of conformity

According to ISO/IEC Guide 22 and EN 45014

Manufacturer's name and address:	
Hewlett-Packard Company, 16399 West Bernardo Drive, San Diego, CA 92127-1899, USA	
Regulatory model number:	SDGOB-0303
Declares that the product:	
Product name:	HP PSC 1300 Series (Q3500A)
Model number(s):	HP PSC 1340 (Q3492A), 1345 (Q3493A), 1350 (Q3501A, Q3495A), 1350xi (Q3502A), 1350v (Q3503A), 1350 (Q5533A, Q5534A)- Japan only)
Power adapters:	0950-4466
Conforms to the following product specifications:	
Safety:	IEC 60950:1991+A1+A2+A3+A4 /
	EN 60950:1992+A1+A2+A3+A4+A11
	UL1950/CSA22.2 No.950, 3rd Edition:1995
	NOM 019-SFCl-1993
	GB4943: 2001
EMC:	CISPR 22:1997 / EN 55022:1998, Class B
	CISPR 24:1997 / EN 55024:1998
	IEC 61000-3-2:1995 / EN 61000-3-2:1995
	IEC 61000-3-3:1994 / EN 61000-3-3:1995
	AS/NZS3548
	CNS13438, VCCI-2
	FCC Part 15 - Class B/ICES-003, Issue 2
	GB9254:1998
Supplementary Information:	
The product herewith complies with the requirements of the Low Voltage Directive 73/23/EC, the EMC Directive 89/336/EC and carries the CE marking accordingly.	
<ul style="list-style-type: none"> <li>The product was tested in a typical configuration.</li> </ul>	
European Contact for regulatory topics only: Hewlett Packard GmbH, HQ-TRE, Herrenberger Strasse 140, D-71034 Böblingen Germany. (FAX +49-7031-14-3143)	

HP Instant Share makes it easy to send photos that family and friends can view. Just take a photo or scan an image, select the photograph or image, and use the software on your computer to forward the media to an e-mail destination. You can even upload your photos (depending on your country/region) to an online photo album, or an online photo finishing service.

With HP Instant Share, family and friends always get photos they can view—no more large downloads or images that are too big to open. An e-mail with thumbnail images of your photos is sent with a link to a secure Web page where your family and friends can easily view, share, print, and save your pictures.

**Note:** Some operating systems do not support HP Instant Share, but you can still use your HP Photo & Imaging Director (HP Director) software to send a photo to family and friends as an e-mail attachment. (For more information, see **send a photo or image using your hp psc (Macintosh)** on page 60.)

This section contains the following topics:

- **use hp instant share in five easy steps (Windows)** on page 57
- **send a photo or image using your hp psc (Macintosh)** on page 60
- **why should I register with hp instant share (Windows)?** on page 61

## use hp instant share in five easy steps (Windows)

HP Instant Share is easy to use with your HP PSC 1300 Series (HP PSC)—simply:

- 1 Insert a photo memory card in your HP PSC and transfer the contents to your Windows-based computer.

OR

Scan an image using your HP PSC and send it to the HP Photo & Imaging Gallery (HP Gallery) software.

**Note:** The HP Gallery is a part of the HP Director software that comes with your HP PSC. HP Director is installed on your computer.

- 2 From the **HP Gallery**, select the photograph or image you want to send.
- 3 From the **HP Instant Share** tab, click **Start HP Instant Share**.
- 4 Create an e-mail destination within HP Instant Share.

**Note:** You can also set up an Address Book to retain your e-mail addresses.

- 5 Send your e-mail message.

For specific information on how to use HP Instant Share, see the following procedures:

- **use the photo transfer feature** on page 58
- **use a scanned image** on page 58
- **access hp instant share from the hp director** on page 59

**Note:** Your computer must be connected to the Internet to use HP Instant Share. If you are an AOL or CompuServe user, please connect to your Internet service provider before attempting to use HP Instant Share.

### use the photo transfer feature

For more information on photo memory cards, see **use a photo memory card** on page 17.

- 1 Insert the memory card into the appropriate slot on your HP PSC.
- 2 A dialog box automatically appears on your computer screen prompting you to transfer the memory card's contents to the computer.
- 3 Press the appropriate button in the dialog box to begin the process.  
This saves the photos from the memory card to your computer that have not been transferred.

**Note:** By default, files are saved in month and year folders depending on when the photos were taken. The folders are created under the **C:\Documents and Settings\username\My Documents\My Pictures** folder in Windows XP and Windows 2000.

The HP Gallery automatically opens and displays the photos.

- 4 Select a photo.  
**Note:** For more information, see the onscreen **hp photo & imaging help** that came with your software.
- 5 Click the **HP Instant Share** tab.
- 6 To access the photos for use with HP Instant Share, go to step 5 in **access hp instant share from the hp director** on page 59.

### use a scanned image

For information on scanning an image, see **use the scan features** on page 29.

- 1 Load your original face down in the left front corner of the glass.
- 2 Press **Scan**.  
A preview image of the scan appears in the HP Scan window on the computer, where you can edit it.  
For more information about editing a preview image, see the onscreen **hp photo & imaging help** that came with your software.
- 3 Make any needed edits to the preview image in the **HP Scan** window. When you have finished, click **Accept**.  
The HP PSC sends the scan to the HP Gallery, which automatically opens and displays the image.
- 4 After you have edited the scanned image, select it.



**Note:** The HP Gallery has many editing tools that you can use to edit your image and achieve the results you want. For more information, see the onscreen **hp photo & imaging help** that came with your software.

- 5 Click the **HP Instant Share** tab.
- 6 To use HP Instant Share, go to step 5 in **access hp instant share from the hp director** on page 59.

### access hp instant share from the hp director

This section addresses how to use the HP Instant Share e-mail service. The terms photo and image are both referred to as image in this section. For more information on using the HP Director, see the onscreen **hp photo & imaging help** that came with your software.

- 1 Open the **HP Director**.
- 2 From the **HP Director**, click **HP Gallery**.  
The HP Photo & Imaging Gallery appears.
- 3 Select an image from the folder in which it is stored.  
**Note:** For more information, see the onscreen **hp photo & imaging help** that came with your software.
- 4 Click the **HP Instant Share** tab.
- 5 In the **Control** area, click **Start HP Instant Share**.  
The Go Online screen appears in the Work area.
- 6 Click **Next**.  
The One-Time Setup—Region and Terms of Use screen appears.
- 7 Select your country/region from the drop-down list.
- 8 Read the **Terms of Service**, select the **I agree** check box, and click **Next**.  
The Select an HP Instant Share Service screen appears.
- 9 Select **HP Instant Share E-mail**: send images through e-mail.
- 10 Click **Next**.
- 11 At the Create HP Instant Share E-Mail screen, complete the **To**, **From**, **Subject**, and **Message** fields.  
**Note:** To open and maintain an e-mail address book, click Address Book, register with HP Instant Share, and obtain a HP Passport.  
**Note:** To send your e-mail message to multiple addresses, click How to e-mail multiple people.
- 12 Click **Next**.  
The Add Captions screen appears.
- 13 Enter a caption for your digital image, and then click **Next**.  
Your image is uploaded to the HP Instant Share services website.  
After the image is uploaded, the Photos E-mailed screen appears.  
Your e-mail is sent with a link to a secure Web page that stores your image for 60 days.
- 14 Click **Finish**.  
The HP Instant Share website opens in your browser.

From the website, you can select an image, and choose from a number of processing options.

## send a photo or image using your hp psc (Macintosh)

If your HP PSC is connected to a Macintosh, you can send a photo or image to anyone with an e-mail account. You can initiate your e-mail message from an e-mail application installed on your computer by pressing E-mail in the HP Gallery. You open the HP Gallery from the HP Director.

This section contains the following topics:

- **use the photo transfer feature** on page 58
- **use a scanned image** on page 60
- **access the e-mail option from the hp director** on page 61

### use the photo upload feature

For more information on photo memory cards, see **use a photo memory card** on page 17.

- 1 Insert the memory card into the appropriate slot on your HP PSC.
- 2 A dialog box automatically appears on your computer screen prompting you to transfer the memory card's contents to the computer.
- 3 Press the appropriate button in the dialog box to begin the process.  
This saves all the photos from the memory card to your computer that have not already been transferred.

**Note:** By default, files are saved to the computer in the default location **Hard Drive:Documents:HP All-in-One Data:Photos** folder (OS 9) or **Hard Drive:Users:User Name:Pictures:HP Photos** folder (OS X).

**Note:** On a Macintosh you can use iPhoto as a transfer destination instead of HP Gallery. See the **use iphoto** section in the **hp photo and imaging help** that came with your software.

- 4 To access the photos for use with HP Instant Share, see **access the e-mail option from the hp director** on page 61.

### use a scanned image

For information on scanning an image, see **use the scan features** on page 29.

- 1 Load your original face down in the left front corner of the glass.
- 2 Press **Scan**.  
A preview image of the scan appears in the HP Scan window on the computer, where you can edit it.  
For more information about editing a preview image, see the onscreen **hp photo and imaging help** that came with your software.
- 3 Make any needed edits to the preview image in the **HP Scan** window. When you have finished, click **Accept**.  
The HP PSC sends the scan to the HP Gallery, which automatically opens and displays the image.

- 4 After you have edited the scanned image, select it.

**Note:** The HP Gallery has many editing tools that you can use to edit your image and achieve the results you want. For more information, see the onscreen **hp photo and imaging help** that came with your software.

- 5 Click **E-mail**.

The e-mail program on your Macintosh opens.

You can now send the images as an e-mail attachment by following the prompts on your Macintosh.

### access the e-mail option from the hp director

For more information on using the HP Director, see the onscreen **hp photo and imaging help** that came with your software.

- 1 Open the **HP Director** and click **HP Gallery** (OS 9).

OR

Click **HP Director** in the Dock, and select **HP Gallery** from the **Manage and Share** section of the **HP Director** menu (OS X).

The HP Photo and Imaging Gallery opens.

- 2 Select an image.

For more information, see the onscreen **hp photo and imaging help** that came with your software.

- 3 Click **E-mail**.

The e-mail program on your Macintosh opens.

You can now send the images as an e-mail attachment by following the prompts on your Macintosh.

## why should I register with hp instant share (Windows)?

With the HP PSC 1300 Series, HP Instant Share user registration is only required if you choose to use the Address Book. User registration is a separate log-on process from the HP product registration and is accomplished using the HP Passport setup program.

If you choose to save e-mail addresses and create distribution lists in a HP Instant Share Address Book, you will be prompted to register. Registration is required prior to configuring the Address Book and accessing the Address Book when addressing an HP Instant Share e-mail.



This section contains troubleshooting information for the HP PSC 1300 Series (HP PSC). Specific information is provided for installation and configuration issues. References to our online troubleshooting help are provided for operational topics.

This section contains the following:

- **installation troubleshooting** on page 63
- **operational troubleshooting** on page 69

## installation troubleshooting

Installation and configuration troubleshooting tips are included in this section for some of the most common issues associated with HP PSC software and hardware installation, and HP Instant Share.

This section contains the following topics:

- **hardware and software installation troubleshooting** on page 63
- **hp instant share setup troubleshooting** on page 69

### hardware and software installation troubleshooting

If you encounter a software or hardware problem during installation, see the topics below for a possible solution.

During a normal installation of the HP PSC software, the following things occur:

- The HP PSC CD-ROM runs automatically when the CD-ROM is inserted
- The software installs
- Files are copied to your hard drive
- You are requested to plug in the HP PSC
- A green OK and check mark appear on an installation wizard screen
- You are requested to restart your computer (might not occur in all cases)
- The registration process runs

If any of these things do occur, there might be a problem with the installation. To check the installation on a PC, verify the following:

- Start the HP Director and check to make sure the following icons appear: scan picture, scan document, and hp gallery. For information about starting HP Director, see **use your hp psc with a computer** on page 6. If the icons do not appear immediately, you might need to wait a few minutes for the HP PSC to connect to your computer. Otherwise, see **Some of the icons are missing in the hp director** on page 66.
- Open the Printers dialog box and check to see that the HP PSC is listed.
- Look at the task tray for an HP PSC icon. This indicates that the HP PSC is ready.

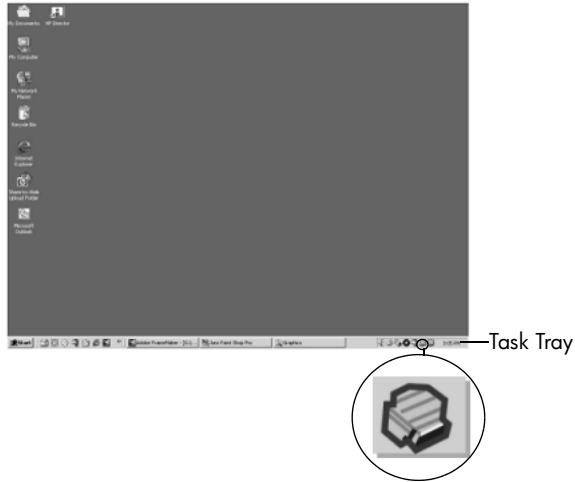

### software installation troubleshooting

Use this section to solve any problems you might encounter while installing the HP PSC software.

problem	possible cause and solution
When I insert the CD-ROM into my computer's CD-ROM drive, nothing happens	<p><b>follow these steps</b></p> <ol style="list-style-type: none"> <li><b>1</b> From the Windows <b>Start</b> menu, choose <b>Run</b>.</li> <li><b>2</b> In the Run dialog box, enter <b>d:\setup.exe</b> (if your CD-ROM drive is not assigned to drive letter d, use the appropriate drive letter), and then click <b>OK</b>.</li> </ol>
The minimum system checks screen appears during installation	Your system does not meet the minimum requirements to install the software. Click <b>Details</b> to see what the specific problem is. Then correct the problem before attempting to install the software.

**problem**

A red X or yellow triangle appears on the USB connect prompt

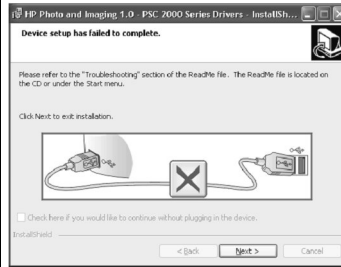
**possible cause and solution****do the following**

- 1 Verify that the front panel cover is firmly adhered to the device, then unplug the HP PSC and plug it in again.  
For more information on how to attach the front panel cover, see **I received a message to attach the front panel cover** on page 68.
- 2 Verify that the USB and power cables are plugged in.

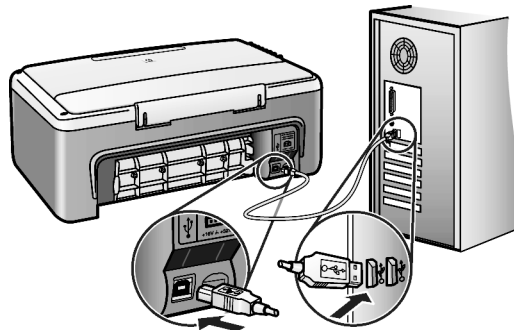

- 3 Verify that the USB cable is set up properly as follows:
  - Unplug the USB cable and plug it in again.
  - Do not attach the USB cable to a keyboard or non powered hub.
  - Verify that the USB cable is 3 meters or less in length.
  - If you have several USB devices attached to your computer, you might want to unplug the other devices during the installation.
- 4 Continue with the installation and reboot the computer when prompted. Then open HP Director and check for the essential icons (scan picture, scan document, and hp gallery)  
If the essential icons do not appear, remove the software and then reinstall it as described in **Some of the icons are missing in the hp director** on page 66.

I received a message that an unknown error has occurred

Try to continue with the installation. If that doesn't work, stop and then restart the installation.

problem	possible cause and solution
<p>Some of the icons are missing in the hp director</p>	<p>If the essential icons (scan picture, scan document, and HP Gallery) do not appear, your installation might not be complete. For more information, see <b>Some of the icons are missing in the hp director</b> on page 66.</p> <p>If your installation is incomplete you might need to uninstall and then reinstall the software. Do <i>not</i> simply delete the HP PSC program files from your hard drive. Be sure to remove them properly using the uninstall utility provided in the HP PSC program group.</p> <p><b>to uninstall from a Windows computer</b></p> <ol style="list-style-type: none"> <li>1 Disconnect your HP PSC from your computer.</li> <li>2 On the Windows task bar, click <b>Start, Programs</b> or <b>All Programs (XP), Hewlett-Packard, HP PSC 1300 Series, uninstall software</b>.</li> <li>3 Finally, make sure that the print driver is installed.</li> <li>4 Follow the directions on the screen. <p><b>Note:</b> Make sure the HP PSC is disconnected from your computer before continuing with uninstall procedure.</p> </li> <li>5 If you are asked whether you would like to remove shared files, click <b>No</b>. <p>Other programs that use these files might not work properly if the files are deleted.</p> </li> <li>6 After the software is uninstalled, restart your computer.</li> <li>7 To reinstall the software, insert the HP PSC 1300 Series CD-ROM into your computer's CD-ROM drive, and follow the onscreen instructions.</li> <li>8 After the software is installed, connect the HP PSC to your computer. Turn on the HP PSC by pressing the On/Resume button. To continue with the installation, follow the onscreen instructions and the instructions provided in the Setup Poster that came with your HP PSC. <p>After connecting and turning on your HP PSC, you might have to wait several minutes for all of the Plug and Play events to complete.</p> <p>When the software installation is complete, you will see a Digital Imaging Monitor icon in the task tray.</p> </li> <li>9 To verify that the software is properly installed, double-click the HP Director icon on the desktop. If the HP Director shows the essential icons (scan picture, scan document, and HP Gallery), the software has been properly installed.</li> </ol>

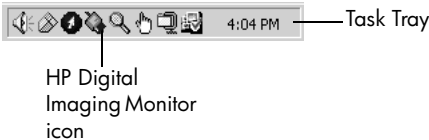

problem	possible cause and solution
Some of the icons are missing in the hp director (continued)	<p><b>to uninstall from a Macintosh computer</b></p> <ol style="list-style-type: none"> <li>1 Disconnect the HP PSC from your computer.</li> <li>2 Double-click the <b>Applications:HP All-in-One Software</b> folder.</li> <li>3 Double-click <b>HP Uninstaller</b>.</li> <li>4 Follow the onscreen instructions.</li> <li>5 After the software is uninstalled, disconnect your HP PSC, and restart your computer.</li> <li>6 To reinstall the software, insert the HP PSC 1300 Series CD-ROM into your computer's CD-ROM drive. <b>Note:</b> When reinstalling the software, follow the instructions on the Setup Poster. Do not connect the HP PSC to your computer until after you have completed the software installation.</li> <li>7 On the desktop, open the CD-ROM, double-click <b>hp all-in-one installer</b>, and follow the onscreen instructions.</li> </ol>
The registration screen does not appear	<p>Launch the Product Registration program in the HP folder on the Windows <b>Start</b> menu. Click <b>Start, Programs</b> or <b>All Programs (XP), Hewlett-Packard, HP PSC 1300 Series, product registration</b>.</p>
The Digital Imaging Monitor does not appear in the Task Tray	<p>If the Digital Imaging Monitor does not appear in the Task Tray, wait several minutes. If it still doesn't appear, start the HP Director to check whether or not essential icons are there. For more information, see <b>Some of the icons are missing in the hp director</b> on page 66.</p> <p>The Task Tray normally appears in the lower-right corner of the Windows desktop.</p>  <p>The image shows a portion of the Windows taskbar. On the right side, there is a clock displaying '4:04 PM' and a label 'Task Tray' with a line pointing to the taskbar area. To the left of the clock, several icons are visible. One icon, representing the HP Digital Imaging Monitor, is highlighted with a white rectangular box. A callout box with a line pointing to this icon contains the text 'HP Digital Imaging Monitor icon'.</p>
The installation stops when the additional setup instruction screen appears, even though the USB cable is plugged in.	<p>The front panel cover might not be properly attached.</p> <p><b>follow these steps</b></p> <ol style="list-style-type: none"> <li>1 Check the front panel for an error message about attaching the front panel cover.</li> <li>2 If necessary, attach the front panel cover. For more information, see <b>I received a message to attach the front panel cover</b> on page 68.</li> <li>3 Turn off the product and then turn it back on again.</li> </ol>

## hardware installation troubleshooting

Use this section to solve any problems you might encounter while installing the HP PSC hardware.

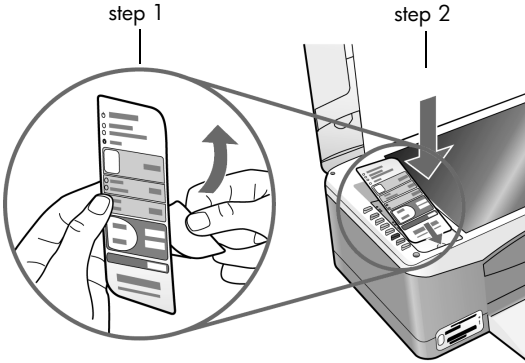
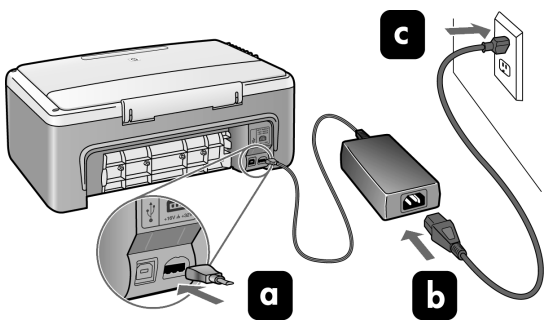
problem	possible cause and solution
<p>I received a message to attach the front panel cover</p>	<p>The front panel cover is not attached, or it is attached incorrectly.</p> <p><b>to attach the front panel cover</b></p> <ol style="list-style-type: none"> <li>1 Remove the adhesive backing from the front panel cover.</li> </ol>  <ol style="list-style-type: none"> <li>2 Raise the lid of the HP PSC. Place the front panel cover into the recess and stick it into place.</li> </ol> <p><b>Note:</b> The HP PSC will not work until you attach the front panel cover.</p>
<p>My HP PSC does not turn on</p>	<p>Make sure each of the power cords is firmly connected, and wait a few seconds for the HP PSC to turn on. Also, if the HP PSC is plugged in to a power strip, make sure the strip is turned on.</p> 

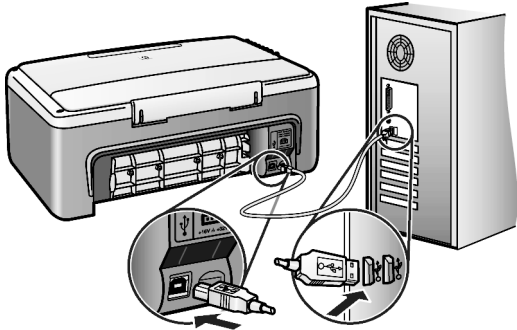
problem	possible cause and solution
The USB port is not connected	<p>Connecting your computer to your HP PSC with a USB cable is straightforward. Simply plug one end of the USB cable into the back of your computer and the other into the back of the HP PSC. You can connect to any USB port on the back of your computer.</p> 

### hp instant share setup troubleshooting

HP Instant Share setup errors (such as might occur when setting up the Address Book) are covered in the HP Instant Share screen-specific help. Specific operational troubleshooting information is provided in **operational troubleshooting** below.

## operational troubleshooting

The **hp psc 1300 series** troubleshooting section in the **hp photo & imaging help** contains troubleshooting tips for some of the most common issues associated with your HP PSC. To access the troubleshooting information from a Windows computer, go to the HP Photo & Imaging Director, click Help, and then choose Troubleshooting and Support. Troubleshooting is also available through the Help button that appears on some error messages.

To access troubleshooting information from the Macintosh (OS X), click the HP Director (All-in-One) icon in the Dock, select HP Help from the HP Director menu, select HP Photo and Imaging Help, and then click hp psc 1300 series troubleshooting in the Help Viewer.

If you have Internet access, you can get help from the HP website at:

**[www.hp.com/support](http://www.hp.com/support)**

The website also provides answers to frequently asked questions.

## hp instant share troubleshooting

Basic HP Instant Share troubleshooting topics are covered in the table below. When you access the HP Instant Share website, online help is provided for any error messages encountered.

error message	possible cause and solution
Can't connect to the Internet	Your computer is unable to connect to the HP Instant Share server after the Go Online screen appears. <ul style="list-style-type: none"> <li>• Check your Internet connection and make sure you are online.</li> <li>• If you are behind a firewall, verify that your browser proxy settings are correct.</li> </ul>
HP Instant Share Service temporarily unavailable	The HP Instant Share server is currently down for maintenance. <ul style="list-style-type: none"> <li>• Try connecting again later.</li> </ul>

## photo memory card troubleshooting

If your HP PSC is connected to a computer, an error message might appear if there are problems with the proof sheet or photo memory card features. If your HP PSC is not connected to a computer, the amber Photo Error light might blink, but there will be no error messages to inform you about the specific cause of the problem. Here are some problems you might encounter at each stage of using a memory card and proof sheet to produce prints.

problem	possible cause and solution
You insert a memory card, nothing seems to happen	<ul style="list-style-type: none"> <li>• The memory card is not fully inserted. Remove and reinsert the memory card.</li> <li>• The memory card is inserted incorrectly. Remove and reinsert the memory card.</li> <li>• There was already a memory card in a slot. Remove one memory card. The HP PSC reads the remaining memory card.</li> <li>• The memory card is defective or damaged. Reformat the memory card or use a new one.</li> <li>• There are no photos on the memory card. Use the memory card in a digital camera, take some photos, and then use it in your HP PSC.</li> </ul>
You press the Photo button, but the HP PSC does not print a proof sheet	<ul style="list-style-type: none"> <li>• Small media is loaded in the paper tray (proof sheets require Letter or A4 paper). Place Letter or A4 paper in the paper tray.</li> <li>• No photo memory card was in a slot when you tried to print a proof sheet. Insert a memory card in the appropriate memory card slot, wait for it to be read, and try again.</li> <li>• The HP PSC had not finished reading the memory card. It can take several minutes for the HP PSC to read a memory card that contains many images. Wait for the Read Status LED to stop blinking before you press the Photo button.</li> <li>• There is a document already on the glass. Remove all documents from the glass before printing a proof sheet.</li> </ul>

<b>problem</b>	<b>possible cause and solution</b>
Some or all of the photos selected on the proof sheet do not print	<ul style="list-style-type: none"><li>• The paper size selected on the proof sheet does not match the contents of the paper tray. Load the same size paper in the paper tray as selected on the proof sheet.</li><li>• The proof sheet is not readable. Print a new sheet, complete it, and try again.</li><li>• The proof sheet is placed incorrectly on the glass. Place the top of the completed proof sheet face down on the scanner glass in the left front corner, and then close the lid.</li><li>• You are using an outdated proof sheet and the photos have been deleted from the card since you printed the proof sheet. Print a new, up-to-date proof sheet.</li><li>• You forgot to fully complete the proof sheet. Make sure to select at least one photo as well as one paper type and one layout (or the small paper, photo paper only option).</li><li>• You chose more than one paper type or layout. Print a new proof sheet, complete it correctly, and then scan it to create prints.</li></ul>



## Numerics

- 4 by 6 inch (10 by 15 cm)
  - borderless copies, **26**
  - photo paper, **14**

## A

- align print cartridges, **37**

## B

- best copy quality, **26**
- borderless photos, **22**
  - copy, **26**

## C

- cancel
  - copy, **28**
  - scan, **30**
- cartridges, **32**
  - align, **37**
  - clean contacts, **39**
  - handle, **33**
  - ink level, **32**
  - replace, **34**
  - store, **36**
- clean
  - exterior, **32**
  - glass, **31**
  - lid backing, **31**
  - print cartridge contacts, **39**
- CompactFlash memory card, **17**
- copy
  - black-and-white originals, **25**
  - borderless photos, **26**
  - color originals, **25**
  - enlarge, **27**
  - number of copies, **26**
  - photos, **26**
  - photos onto letter paper, **27**
  - quality, **26**
  - reduce, **27**
  - speed, **26**
- customer support, **41**
  - Australia, **44**
  - Japan, **42**
  - North America, **42**
  - outside U.S., **42**
  - web site, **41**

## E

- e-mail photos, **23**
- enlarge copies, **27**
- envelopes
  - load, **14**
- environment
  - energy consumption, **53**
  - environmental product stewardship program, **53**
  - inkjet supplies recycling, **54**
  - material safety data sheets, **53**
  - ozone production, **53**
  - paper use, **53**
  - plastics, **53**
  - protecting, **53**
  - recycling program, **53**

## F

- fast copy quality, **26**
- fit to page, **27**
- front panel
  - overview, **1**
  - status lights, **3**

## G

- glass cleaning, **31**
- greeting cards, load, **15**

## H

- Hagaki cards, **14**
- help, **v**
- HP customer support, **41**
- HP Director
  - e-mail option (Macintosh), **61**
  - HP Instant Share access (Windows), **59**
  - use your hp psc with a computer, **6**
- HP distribution center, **45**
- HP Instant Share
  - Address Book, **61**
  - overview, **57**
  - simplified approach, **57**
  - use a scanned image, **58**
  - use photo upload, **58**

## I

- ink cartridges, **32**
- ink level, **32**

## L

- labels
  - load, **15**
- lid backing, clean, **31**
- lights, status, **3**
- load
  - A4 paper, **12**
  - avoid paper jams, **16**
  - envelopes, **14**
  - greeting cards, **15**
  - Hagaki cards, **14**
  - HP Premium Paper, **15**
  - labels, **15**
  - letter paper, **12**
  - originals, **11**
  - postcards, **14**
  - recommended papers, **15**

## M

- maintenance
  - align print cartridges, **37**
  - clean glass, **31**
  - clean the exterior, **32**
  - clean the lid backing, **31**
  - ink level, **32**
  - replace print cartridges, **34**
  - self-test report, **33**
  - sounds, **40**
- memory cards
  - insert a card, **18**
  - overview, **17**
  - proof sheet, print, **19**
  - proof sheet, scan, **21**
  - save files to computer, **18**
  - slots, correct cards for, **17**
- Memory Stick memory cards, **17**
- MultiMediaCard (MMC)
  - memory card, **17**

## N

- number of copies
  - copy, **26**

**O**

order print cartridges, **75**

**P**

paper

load, **11**

recommended types, **15**

set type, **15**

phone numbers, customer support, **41**

photos

borderless copies, **26**

borderless prints, **22**

edit, **23**

e-mail, **23**

print from proof sheet, **19**

save from memory cards, **18**

postcards, **14**

print

proof sheet, **19**

self-test report, **33**

print cartridge protector, **36**

print cartridges, **32**

align, **37**

clean contacts, **39**

correct one for job, **36**

handle, **33**

ink level, **32**

protector, **36**

replace, **34**

store, **36**

proof sheet

fill out, **20**

print, **19**

scan, **21**

**Q**

quality

copies, **26**

**R**

reduce copies, **27**

regulatory notices, **54**

Australian statement, **55**

declaration of conformity

(European Union), **55**

declaration of conformity

(U.S.), **56**

FCC statement, **54**

geräuschemission, **55**

Korean statement, **55**

notice to users in Canada, **54**

regulatory model

identification number, **54**

VCCI-2 (Japan), **55**

replace print cartridges, **34**

report, self-test, **33**

return your HP PSC, **44**

**S**

save files from memory cards, **18**

scan

cancel, **30**

from the front panel, **29**

proof sheet, **21**

Secure Digital memory card, **17**

self-test report, **33**

send a photo

Macintosh, **60**

use a scanned image, **60**

use photo upload, **60**

ship your HP PSC, **44**

size

copies, **27**

SmartMedia memory card, **17**

software

use your hp psc with a

computer, **6**

sounds from the HP PSC, **40**

speed

copy, **26**

status lights, **3**

stop

copy, **28**

scan, **30**

support, **41**

**T**

technical information

copy specifications, **52**

environmental

specifications, **52**

paper specifications, **51**

photo memory card

specifications, **52**

physical specifications, **52**

power specifications, **52**

print margin specifications, **51**

telephone numbers, customer support, **41**

troubleshooting

hardware and software

installation, **63**

hardware installation, **68**

HP Instant Share setup, **69**

HP Instant Share use, **70**

installation, **63**

operations, **69**

photo memory card use, **70**

software installation, **64**

**U**

USB cable installation, **69**

**W**

warranty

duration, **47**

service, **47**

statement, **48**

upgrades, **47**

**X**

xD memory card, **17**



## order media

To order media such as HP Premium Paper, HP Premium Inkjet Transparency Film, HP Iron-On paper, or HP Greeting Cards, go to:

**[www.hp.com](http://www.hp.com)**

Choose your country/region, and then select Buy or Shopping.

## order print cartridges

The following table lists the print cartridges for your HP PSC. Use the information below to determine which print cartridge to order.

<b>print cartridges</b>	<b>hp reorder number</b>
HP black inkjet print cartridge	#56, 19 ml black print cartridge
HP tri-color inkjet print cartridge	#57, 17 ml color print cartridge
HP photo inkjet print cartridge	#58, 17 ml color print cartridge

Get more information about print cartridges from the HP website.

**[www.hp.com](http://www.hp.com)**

Choose your country/region, and then select Buy or Shopping.

## Visit the hp psc information center

It has everything you need to get the most value from your HP PSC.

- Technical Support
- Supplies and Ordering Information
- Project Tips
- Ways to Enhance Your Product

[www.hp.com/support](http://www.hp.com/support)

© 2003 Hewlett-Packard Company



Printed on recycled paper.

Printed in the U.S.A., Mexico, Germany, or Singapore.



**Q3500-90155**